

Micro HI-FI Component System

Operating Instructions



S-master
Digital Amplifier

CMT-CPZ1

WARNING

To reduce the risk of fire or electric shock, do not expose this apparatus to rain or moisture.

To reduce the risk of fire, do not cover the ventilation of the apparatus with newspapers, tablecloths, curtains, etc. And do not place lighted candles on the apparatus. To reduce the risk of fire or electric shock, do not place objects filled with liquids, such as vases, on the apparatus.

Connect the unit to an easily accessible AC outlet. Should you notice an abnormality in the unit, disconnect the main plug from the AC outlet immediately.

Do not install the appliance in a confined space, such as a bookcase or built-in cabinet.

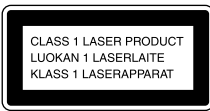

This appliance is classified as a CLASS 1 LASER product. This marking is located on the rear exterior.

Except for European model



ENERGY STAR[®] is a U.S. registered mark. As an ENERGY STAR[®] partner, Sony Corporation has determined that this product meets the ENERGY STAR[®] guidelines for energy efficiency.



Disposal of Old Electrical & Electronic Equipment (Applicable in the European Union and other European countries with separate collection systems)

This symbol on the product or on its packaging indicates that this product shall not be treated as household waste. Instead it shall be handed over to the applicable collection point for the recycling of electrical and electronic equipment. By ensuring this product is disposed of correctly, you will help prevent potential negative consequences for the environment and human health, which could otherwise be caused by inappropriate waste handling of this product. The recycling of materials will help to conserve natural resources. For more detailed information about recycling of this product, please contact your local Civic Office, your household waste disposal service or the shop where you purchased the product.

Applicable accessories: Remote commander

Notice for users

On the supplied software

Depending on the type of the text and characters, the text shown on SonicStage may not be displayed properly on the device. This is due to:

- The limitations of the connected player.
- The player is not functioning normally.

ATRAC, ATRAC3, ATRAC3plus and their logos are trademarks of Sony Corporation.

SonicStage and SonicStage logo are trademarks or registered trademarks of Sony Corporation.

MPEG Layer-3 audio coding technology and patents licensed from Fraunhofer IIS and Thomson.

How to use this manual

- This manual mainly explains operations using the remote, but the same operations can also be performed using the buttons on the unit having the same or similar names.
- This manual describes how to use this system. For details on the supplied software SonicStage, refer to the supplied SonicStage instruction manual “Installation/Operating Guide.”

Table of Contents

| | |
|--|---|
| How to use this manual..... | 2 |
| Create your own ATRAC CDs | 4 |
| Which discs can you play on this system? | 5 |
| About ATRAC CDs and MP3 CDs | 7 |

Getting Started

| | |
|----------------------------|----|
| Hooking up the system..... | 9 |
| Setting the clock..... | 10 |

CD – Play

| | |
|--|----|
| Loading a disc | 11 |
| Playing a disc | 11 |
| — Normal Play/Shuffle Play | |
| Searching for tracks with the jog dial ... | 12 |
| Playing repeatedly..... | 13 |
| — Repeat Play | |
| Creating your own program | 13 |
| — Program Play | |

Tuner

| | |
|---------------------------------------|----|
| Presetting radio stations | 15 |
| Listening to the radio | 16 |
| — Preset Tuning | |
| — Manual Tuning | |
| Using the Radio Data System (RDS).... | 17 |
| (European model only) | |

Tape – Play

| | |
|---------------------|----|
| Loading a tape..... | 18 |
| Playing a tape..... | 18 |

Tape – Recording

| | |
|--|----|
| Recording your favorite CD tracks on a tape..... | 19 |
| — CD-TAPE Synchro Recording | |
| Recording on a tape manually..... | 20 |
| — Manual Recording | |

Sound Adjustment

| | |
|---------------------------|----|
| Adjusting the sound | 21 |
|---------------------------|----|

Timer

| | |
|-------------------------------------|----|
| Falling asleep to music | 21 |
| — Sleep Timer | |
| Waking up to music..... | 22 |
| — Play Timer | |
| Timer recording radio programs..... | 23 |
| — Rec Timer | |

Display

| | |
|---|----|
| Turning off the display | 24 |
| — Power Saving Mode | |
| Viewing information about the disc in the display | 24 |
| Viewing the tuner information in the display | 25 |

Optional Components

| | |
|---|----|
| Hooking up optional components..... | 26 |
| Listening to audio from a connected component | 27 |
| Recording audio from a connected component | 27 |
| Recording on a connected component | 27 |

Troubleshooting

| | |
|----------------------------|----|
| Problems and remedies..... | 28 |
| Messages..... | 31 |

Additional Information

| | |
|---|----|
| Precautions..... | 32 |
| Specifications..... | 33 |
| List of button locations and reference pages..... | 35 |

Create your own ATRAC CDs

In addition to the usual audio CDs, you can play an original CD, called “ATRAC CD,” that you create with the supplied software, SonicStage. Using SonicStage, about 30 audio CDs* can be recorded on one CD-R or CD-RW. The following is a quick overview of how you listen to music on your ATRAC CD.

Install SonicStage on your computer.

SonicStage is software that takes music downloaded from audio CDs on your computer and creates original CDs. It can be installed from the supplied CD-ROM.



Create an ATRAC CD.

After selecting your favorite songs from music stored on your computer, record them on a CD-R/CD-RW using SonicStage.

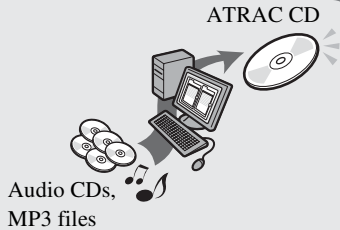

Listen to them with this system.

You can enjoy lots of songs on your original CD.



Please see the supplied “Installation/Operating Guide” for how to install SonicStage and how to create ATRAC CDs.

* When the total playing time of one CD (album) is estimated at 60 minutes and you are recording on a 700MB CD-R/CD-RW at 48 kbps in ATRAC3plus format.

Which discs can you play on this system?



Audio CDs

CD-DA format CDs

CD-DA (Compact Disc Digital Audio) is a recording standard used for audio CDs.



ATRAC CDs:

CD-R/CD-RW on which audio data compressed in the ATRAC3plus format has been recorded by using SonicStage*

ATRAC3plus (Adaptive Transform Acoustic Coding3plus) is audio compression technology that satisfies the demand for high sound quality and high compression rates. ATRAC3plus can compress audio files to about 1/20 of their original size at 64 kbps.

Bit rates and sampling frequencies this system can play are:

| | Bit rates | Sampling frequencies |
|------------|-----------------|----------------------|
| ATRAC3 | 66/105/132 kbps | 44.1 kHz |
| ATRAC3plus | 8 – 352 kbps | 44.1 kHz |

Up to 62 characters can be displayed on this system.



MP3 CDs:

CD-R/CD-RW on which audio data compressed in the MP3 format has been recorded by using a software other than SonicStage*

Bit rates and sampling frequencies this system can play are shown below. Variable Bit Rate (VBR) files can also be played.

| | Bit rates | Sampling frequencies |
|-----------------|---------------|----------------------|
| MPEG-1 Layer3 | 32 – 320 kbps | 32/44.1/48 kHz |
| MPEG-2 Layer3 | 8 – 160 kbps | 16/22.05/23 kHz |
| MPEG-2.5 Layer3 | 8 – 160 kbps | 8/11.025/12 kHz |



This system conforms to Version 1.0/1.1/2.2/2.3/2.4 of the ID3 tag format. ID3 tag is a format for adding certain information (track title, album name, artist name, etc.) to MP3 files. Up to 124 characters of ID3 tag information can be displayed on this system.

An ATRAC CD on which audio data compressed in the MP3 format has been recorded using software other than SonicStage can also be played.

With SonicStage, you cannot create a CD on which mixed format audio data is recorded.

* Only ISO9660 Level 1/2 and Joliet extension format discs can be played.

List of playable discs

| Format of discs | Disc logo |
|---|---|
| Audio CDs |  |
| CD-R/CD-RW (audio data, ATRAC3plus files, MP3 files) |  |

Discs that this system cannot play

- CD-ROMs
- CD-Rs/CD-RWs other than those recorded in the following formats:
 - music CD format
 - ATRAC3plus format and MP3 format that conform to ISO9660¹⁾ Level 1/Level 2, Joliet or Multi Session²⁾
- Discs with non-standard shapes (e.g., heart, square, star) cannot be played on this unit. Attempting to do so may damage the unit. Do not use such discs.
- A disc with paper or stickers on it.
- A disc that has the adhesive, cellophane tape, or a sticker still left on it.
- An 8 cm disc with an adaptor

¹⁾ ISO9660 Format

The most common international standard for the logical format of files and folders on a CD-ROM. There are several specification levels. In Level 1, file names must be in the 8.3 format (no more than eight characters in the name, no more than three characters in the extension) and in capital letters. Folder names can be no longer than eight characters. There can be no more than eight nested folder levels. Level 2 specifications allow file names and folder names up to 31 characters long. Each folder can have up to 8 trees.

For Joliet in the expansion format (file and folder names can have up to 64 characters) make sure of the contents of the writing software, etc.

²⁾ Multi Session

This is a recording method that enables adding of data using the Track-At-Once method. Conventional CDs begin at a CD control area called the Lead-in and end at an area called Lead-out. A Multi Session CD is a CD having multiple sessions, with each segment from Lead-in to Lead-out regarded as a single session.

CD-Extra: This format records audio (audio CD data) on the tracks in session 1 and data on the tracks in session 2.

Mixed CD: This format records data on the first track and audio (audio CD data) on the second and subsequent tracks of a session.

Notes on CD-R and CD-RW

- Some CD-Rs or CD-RWs cannot be played on this system depending upon the recording quality or physical condition of the disc, or the characteristics of the recording device. Furthermore, the disc will not play if it has not been correctly finalized. For more information, see the operating instructions for the recording device.
- Discs recorded on CD-R/CD-RW drives may not be played back because of scratches, dirt, recording condition or the driver's characteristics.
- CD-R and CD-RW discs recorded in multi-session that have not ended by "closing the session" are not supported.
- With formats other than ISO9660 Level 1 and 2, folder names or file names may not be displayed correctly.
- The following discs take a longer time to start playback.
 - a disc recorded with complicated tree structure.
 - a disc recorded in Multi Session.
 - a disc to which data can be added (non-finalized disc).

Note on DualDiscs

A DualDisc is a two sided disc product which mates DVD recorded material on one side with digital audio material on the other side.

However, since the audio material side does not conform to the Compact Disc (CD) standard, playback on this product is not guaranteed.

Music discs encoded with copyright protection technologies

This product is designed to playback discs that conform to the Compact Disc (CD) standard. Recently, various music discs encoded with copyright protection technologies are marketed by some record companies. Please be aware that among those discs, there are some that do not conform to the CD standard and may not be playable by this product.

About ATRAC CDs and MP3 CDs

The structure of ATRAC CDs and MP3 CDs

ATRAC CDs and MP3 CDs consist of “files” and “groups.” A “file” is equivalent to a “track” of an audio CD. A “group” is a bundle of files and is equivalent to an “album.” For MP3 CDs, this system recognizes an MP3 folder as a “group” so that ATRAC CDs and MP3 CDs can be operated in the same way.

Playing order of ATRAC CDs and MP3 CDs

For ATRAC CDs, files are played in the order selected in SonicStage. For MP3 CDs, the playing order may differ depending on the method used to record MP3 files on the disc. In the following example, files are played in order of ① to ⑦.

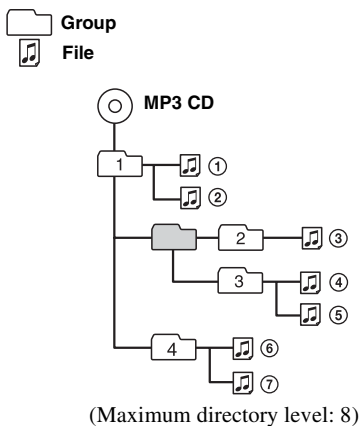

The usable number of groups and files

ATRAC CDs:

- Maximum number of groups: 255
- Maximum number of files: 999

MP3 CDs:

- Maximum number of groups: 256
- Maximum number of files: 511
(The maximum number of MP3 files and groups that can be contained on a single disc is 512)

Notes

- The system may be unable to play MP3 files that do not have the “.MP3” extension.
- Attempting to play non-MP3 files that have the “.MP3” extension may result in noise or malfunction.
- If ATRAC3plus files and MP3 files are recorded on the same disc, this system plays the ATRAC3plus files first.
- On a disc that has ATRAC3plus and MP3 files, do not save files in other formats and do not make unnecessary folders.
- To compress a source in an MP3 file, we recommend setting the compression parameters to “44.1 kHz,” “128 kbps,” and “Constant Bit Rate.”
- To record up to the maximum capacity, set the writing software to “halting of writing.”
- To record to the maximum capacity at one time up on media that has nothing recorded on it, set the writing software to “Disc at Once.”

Cautions when playing a disc that is recorded in Multi Session

- If the disc begins with a CD-DA session, it is recognized as a CD-DA (audio) disc, and ATRAC3plus/MP3 sessions are not played back.
- If the disc begins with an ATRAC3plus/MP3 session, it is recognized as an ATRAC CD/MP3 CD, and CD-DA (audio) sessions are not played back.
- The playback range of an MP3 CD is determined by the tree structure of files produced by analyzing of the disc.
- A disc with a mixed CD format will be recognized as a CD-DA (audio) disc.

Hooking up the system

Perform the following procedures **1** to **3** to hook up your system using the supplied cords and accessories.

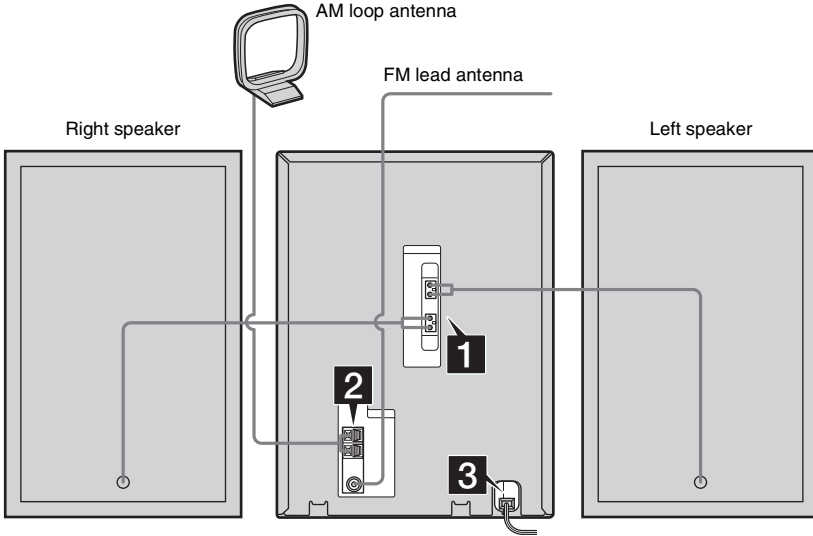

1 Connect the speakers.

Connect the right and left speaker cords to the SPEAKER terminals as shown below.

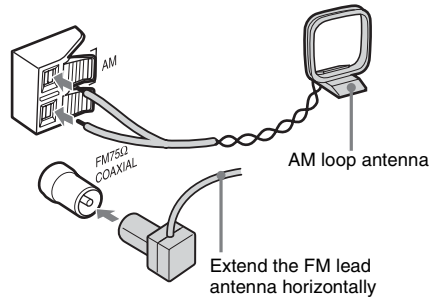
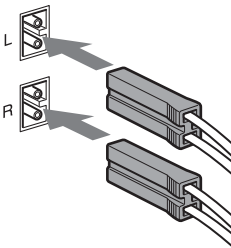

2 Connect the FM and AM antennas.

Set up the AM loop antenna, then connect it.

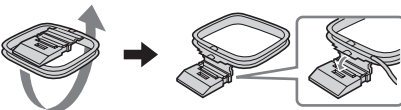

Note

To prevent noise pickup, keep the antennas away from the speaker cords.

3 Connect the mains lead to mains.

If the plug does not fit the wall socket, detach the supplied plug adaptor (only for models equipped with an adaptor). To turn on the system, press I/⏻.

continued

Inserting two R6 (size AA) batteries into the remote

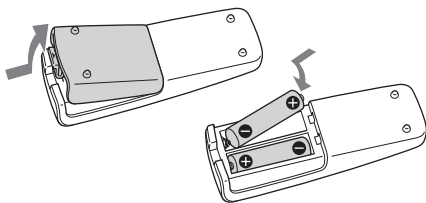

Note

If you do not use the remote for a long period of time, remove the batteries to avoid possible damage from battery leakage and corrosion.

Tip

With normal use, the batteries should last for about six months. When the remote no longer operates the system, replace both batteries with new ones.

Attaching the speaker pads

Attach the supplied speaker pads to the bottom of the speakers to stabilize the speakers and prevent them from slipping.

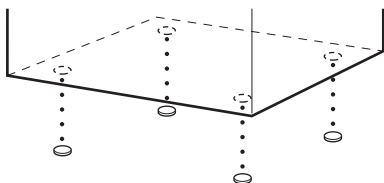

When carrying this system

Perform the following procedure to protect the CD mechanism.

Use buttons on the unit for the operation.

- 1 Press I/⏻ to turn on the system, then press FUNCTION repeatedly to switch the function to CD.
- 2 Make sure that no disc is loaded in the disc slot.
- 3 Hold down CD ■ and then press DSGX and ⊞ until "LOCK" appears.
- 4 Unplug the mains lead.

Setting the clock

Use buttons on the remote for the operation.

- 1 Press I/⏻ to turn on the system.
- 2 Press CLOCK/TIMER SET.
- 3 Press I◀◀ or ▶▶I repeatedly to set the hour.
- 4 Press ENTER.
- 5 Press I◀◀ or ▶▶I repeatedly to set the minute.
- 6 Press ENTER.

The clock starts working.

To adjust the clock

- 1 Press CLOCK/TIMER SET.
- 2 Press I◀◀ or ▶▶I repeatedly to select "CLOCK SET", then press ENTER.
- 3 Do the same procedures as step 3 to 6 above.

Note

The clock is not displayed in Power Saving Mode (page 24).

CD – Play

Loading a disc

- 1 Press CD (or FUNCTION repeatedly) to switch the function to CD.
- 2 Insert a disc in the disc slot with the label side up.



When you play a disc, insert it with the label side up.

Notes

- When you turn on the system, the disc is not pulled into the disc slot until “NO DISC” appears in the display. Do not attempt to push in the disc until “NO DISC” appears.
- Do not use a disc with tape, seals or paste on it as this may cause malfunction.
- Do not load an 8 cm disc with an adaptor. Doing so may cause the system to malfunction.
- When you remove a disc, handle the disc by its edge and pull it straight out of the disc slot. Do not touch the surface.
- If you load a disc that is not playable by this system, it will be ejected automatically.

Playing a disc

— Normal Play/Shuffle Play

This system lets you play CDs in different play modes.

Example: When playing a disc

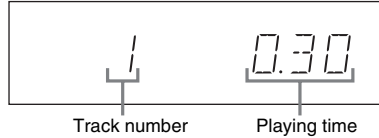

- 1 Press CD (or FUNCTION repeatedly) to switch the function to CD.
- 2 Press PLAY MODE repeatedly in stop mode until the mode you want appears in the display.

| Select | To play |
|-----------------------------|--|
| No display (Normal Play) | The tracks on the disc in original order. |
| (Normal Play) | All the tracks in the group on the ATRAC CD or MP3 CD in original order. When playing an audio CD, the system performs the same operation as Normal Play. |
| SHUF (Shuffle Play) | All the tracks on the disc in random order. |
| SHUF (Shuffle Play) | All the tracks in the group on the ATRAC CD or MP3 CD in random order. When playing an audio CD, the system performs the same operation as Shuffle Play. |
| PGM (Program Play) | The tracks on the disc in the order you want them to be played (see “Creating your own program” on page 13). |

- 3 Press ► (or CD ►|| on the unit).

Other operations

| To | Do this |
|--|---|
| Stop play | Press ■ (or CD ■ on the unit). |
| Pause | Press II (or CD ►II on the unit). Press again to resume play. |
| Select a track | Press ◀◀ or ▶▶ repeatedly. |
| Select a group on the ATRAC CD or MP3 CD | Press ◻ + or - repeatedly after step 2. |
| Find a point in a track | Keep pressing ◀◀ or ▶▶ during playback and release it at the desired point. |
| Remove a disc | Press CD ▲ on the unit. |

Notes

- You cannot change the play mode during playback.
- Some time may be needed to start playback of discs recorded in complex configurations such as many layers.
- Before playing back a track, the system reads all tracks and groups on the disc. During this time, “READING” appears on the display. Depending on the disc content, some time may be needed to read the disc.
- A group that does not include MP3 tracks is skipped.
- Depending on the encoding/writing software, recording device, or the recording media used at the time an MP3 track is recorded, you may encounter such problems as disabled playback, sound interruptions, and noise.
- When playing back an MP3 track, the playback elapsed time indication may differ from the actual time in the following cases.
 - When you play back a VBR (variable bit rate) MP3 track
 - When you perform fast forward or rewind (Manual Search)

Tip

When disc access takes a long time, set “CD POWER” and “ON” by CD power manage function (page 16).

Searching for tracks with the jog dial

You can quickly search for and play the desired track by using the jog dial on the unit.

Use buttons on the unit for the operation.

1 Press FUNCTION repeatedly to switch the function to CD.

2 Turn the jog dial in stop mode to select the desired track, then press PUSH ENTER.

To search for tracks on the ATRAC CD or MP3 CD, turn the jog dial to first select the desired group, then press PUSH ENTER before performing step 2.

Playback starts from the selected track.

Note

Only the first 6 characters are displayed when performing the group or track search.

Tip

You can search for and play other tracks in the selected group during playback. To select a track of another group during playback, turn the jog dial counterclockwise until “GROUP” appears, then press PUSH ENTER and select a group. You can then select the desired track by turning the jog dial.

To cancel the track search

Press CANCEL.

Notes

- If you do not perform any operations for approximately 8 seconds, the display returns to the previous one.
- The track search is not possible in Program Play mode.

Playing repeatedly

— Repeat Play

You can play all the tracks or a single track on a disc repeatedly.

Press REPEAT repeatedly during playback until “REP” or “REP 1” appears.

REP: For all the tracks on the disc up to five times.

REP 1: For a single track only.

To cancel Repeat Play

Press REPEAT repeatedly until both “REP” and “REP 1” disappear.

Note

When you select “REP 1”, that track is repeated endlessly until “REP 1” is canceled.

Creating your own program

— Program Play

You can make a program of up to 25 steps. You can synchro record the programmed tracks onto a cassette tape (page 19).

Using the remote

- 1** Press **CD** (or **FUNCTION** repeatedly) to switch the function to **CD**.
- 2** Press **PLAY MODE** repeatedly in stop mode until “**PGM**” appears.
- 3** Press **◀◀** or **▶▶** repeatedly until the desired track number appears.

When programming the tracks on the ATRAC CD or MP3 CD, press **⏏** + or - repeatedly to select the desired group, then press **◀◀** or **▶▶** repeatedly until the desired track number appears.

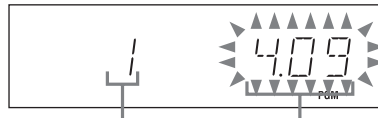

Selected track number

Total playing time

- 4** Press **ENTER**.
The track is programmed.
The program step number appears, followed by the last programmed track number and total playing time.
- 5** To program additional tracks, repeat steps 3 and 4.
- 6** Press **▶** (or **CD ▶||** on the unit).
Program Play starts.

Using the jog dial

Use buttons on the unit for the operation.

1 Press FUNCTION repeatedly to switch the function to CD.

2 Press PLAY MODE repeatedly in stop mode until “PGM” appears.

3 Turn the jog dial to select the desired track.

To program tracks on the ATRAC CD or MP3 CD, turn the jog dial to first select the desired group, then press PUSH ENTER before performing step 3.

4 Press PUSH ENTER.

The track is programmed.

The program step number appears, followed by the last programmed track number and total playing time.

5 To program additional tracks, repeat steps 3 and 4.

6 Press CD ►||.

Program Play starts.

Other operations

| To | Do this |
|---------------------------------------|---|
| Cancel Program Play | Press PLAY MODE repeatedly in stop mode until “PGM” disappears. |
| Erase the program | Press CLEAR in stop mode. Each time you press the button, a track is cleared from the end of the program. |
| Add a track to the end of the program | Perform steps 3 and 4 in stop mode. |

Note

You cannot erase the program during playback.

Tips

- You can program the tracks during playback by using the jog dial.
- The program you made remains after Program Play finishes. To play the same program again, press CD (or FUNCTION repeatedly) to switch the function to CD, then press ► (or CD ►|| on the unit). However, the program is cleared when you eject the disc.
- “-- --” appears when the total program time exceeds 100 minutes, or when you select a track whose number is 21 or over, or when you select an ATRAC3plus/MP3 track.

Presetting radio stations

You can preset up to 20 FM stations and 10 AM stations. You can then tune in any of those stations simply by selecting the corresponding preset number.

Automatic tuning preset

You can automatically tune in all of the stations that can be received in your area and then store the radio frequency of the desired stations.

- 1** Press **TUNER BAND** (or **FUNCTION** repeatedly) to switch the function to **TUNER**.
- 2** Press **TUNER BAND** repeatedly to select **"FM"** or **"AM"**.
- 3** Press **TUNING MODE** repeatedly until **"AUTO"** appears in the display.
- 4** Press **+ or -** (or **TUNING + or -** on the unit).

The frequency changes as the system scans for a station. Scanning stops automatically when a station is tuned in. At that time, **"TUNED"** and **"STEREO"** (for an FM stereo program only) appear.

If "TUNED" does not appear and the scanning does not stop

Set the frequency of the desired radio station as described in steps 3 and 4 of "Manual tuning preset".

- 5** Press **TUNER MEMORY**.

The preset number flashes. Perform steps 6 and 7 while the preset number flashes.



Preset number

- 6** Press **+ or -** (or **TUNING + or -** on the unit) repeatedly to select the desired preset number.
- 7** Press **ENTER**.
- 8** Repeat steps 4 through 7 to store other stations.

Tip

Press **■** to stop scanning.

Manual tuning preset

You can manually tune in and store the radio frequency of the desired stations.

- 1** Press **TUNER BAND** (or **FUNCTION** repeatedly) to switch the function to **TUNER**.
- 2** Press **TUNER BAND** repeatedly to select **"FM"** or **"AM"**.
- 3** Press **TUNING MODE** repeatedly until **"AUTO"** and **"PRESET"** disappear from the display.
- 4** Press **+ or -** (or **TUNING + or -** on the unit) repeatedly to tune in the desired station.
- 5** Press **TUNER MEMORY**.
- 6** Press **+ or -** (or **TUNING + or -** on the unit) repeatedly to select the desired preset number.
- 7** Press **ENTER**.
- 8** Repeat steps 4 through 7 to store other stations.

Other operations

| To | Do this |
|---|---|
| Tune in a station with a weak signal | Follow the procedure described in "Manual tuning preset". |
| Set another station to the existing preset number | After step 5, press + or - (or TUNING + or - on the unit) repeatedly to select the preset number you want to store the station. |

To change the AM tuning interval (except for European model)

The AM tuning interval is factory-preset to 9 kHz (or 10 kHz for some areas). To change the AM tuning interval, tune in any AM station first, then turn off the system. While holding TUNING +, press I/⏻ on the unit. When you change the interval, all the AM preset stations are erased. To reset the interval, repeat the same procedure.

Note

You cannot change the AM tuning interval in Power Saving Mode (page 24).

Tips

- The preset stations are retained for about half a day even if you disconnect the mains lead or if a power failure occurs.
- To improve broadcast reception, adjust the supplied antennas, or connect a commercially available external antenna.

To improve tuner reception

When tuner reception is poor, set CD player power off by CD power management function. CD power is factory set to on.

Use buttons on the unit for the operation.

- 1 Press FUNCTION repeatedly to switch the function to CD.
- 2 Press I/⏻ to turn off the system.
- 3 After “STANDBY” stops flashing, press I/⏻ while holding CD ■.
“CD POWER” and “OFF” appear.

To set CD power on

Repeat the procedure above and “CD POWER” and “ON” appear.

Notes

- When “CD POWER” and “OFF” are selected, disc access time is increased.
- You cannot change the setting in Power Saving Mode (page 24).

Listening to the radio

You can listen to a radio station either by selecting a preset station, or by manually tuning in the station.

Listening to a preset station

— Preset Tuning

Preset radio stations in the tuner’s memory first (see “Presetting radio stations” on page 15).

- 1 Press TUNER BAND (or FUNCTION repeatedly) to switch the function to TUNER.
- 2 Press TUNER BAND repeatedly to select “FM” or “AM”.
- 3 Press TUNING MODE repeatedly until “PRESET” appears in the display.
- 4 Press + or – (or TUNING + or – on the unit) repeatedly to select the desired preset station.

Listening to non-preset radio station

— Manual Tuning

- 1** Press **TUNER BAND** (or **FUNCTION** repeatedly) to switch the function to **TUNER**.
- 2** Press **TUNER BAND** repeatedly to select **“FM”** or **“AM”**.
- 3** Press **TUNING MODE** repeatedly until **“AUTO”** and **“PRESET”** disappear from the display.
- 4** Press **+ or –** (or **TUNING + or –** on the unit) repeatedly to tune in the desired station.

Note

When switching to CD function from tuner, a longer time may be required to access the disc. In this case, set **“CD POWER”** and **“ON”** by CD power manage function (page 16).

Tips

- To improve broadcast reception, adjust the supplied antennas, or connect a commercially available external antenna.
- When an FM stereo program has static noise, press **FM MODE** repeatedly until **“MONO”** appears. There will be no stereo effect, but the reception will improve.
- When an FM stereo program cannot be received in stereo, press **FM MODE** repeatedly until **“STEREO”** appears in the display.
- Press **TUNING MODE** repeatedly until **“AUTO”** appears in step 3 above, then press **+ or –** (or **TUNING + or –** on the unit). The frequency indication changes and scanning stops when the system tunes in a station (Automatic Tuning).
- To record the radio programs, use manual recording (page 20).

Using the Radio Data System (RDS)

(European model only)

What is the Radio Data System?

Radio Data System (RDS) is a broadcasting service that allows radio stations to send additional information along with the regular program signal. RDS is available only on FM stations.*

Note

RDS may not work properly if the station you are tuned in is not transmitting the RDS signal properly or if the signal is weak.

* Not all FM stations provide RDS service, nor do they provide the same types of services. If you are not familiar with the RDS system, check with your local radio stations for details on RDS services in your area.

Receiving RDS broadcasts

Simply select a station from the FM band.

When you tune in a station that provides RDS services, the station name appears in the display.

To check the RDS information

Each time you press **DISPLAY**, the display changes cyclically as follows:
 Station name¹⁾ → Preset number²⁾ and frequency → Clock display (for eight seconds) → Bass level (for eight seconds) → Treble level (for eight seconds)

¹⁾ If the RDS broadcast is not properly received, the station name may not appear in the display.

²⁾ Preset number is displayed only if you preset radio stations (page 15).

Tape – Play

Loading a tape

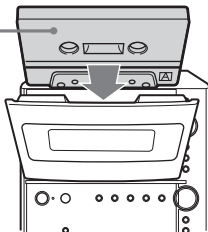

- 1 Press **TAPE**  on the unit.
- 2 Load a recorded/recordable tape into the cassette holder.

With the side you want to play/record facing towards you.



Playing a tape







You can use TYPE I (normal) tape.

- 1 Load a tape.
- 2 Press **TAPE** (or **FUNCTION** repeatedly) to switch the function to **TAPE**.
- 3 Press **DIRECTION** on the unit repeatedly to select “” to play one side. Select “” or “” to play both sides.

* The tape deck stops automatically after repeating the sequence 5 times.

- 4 Press **▶** (or **TAPE**  on the unit). The tape starts playing. Press the button again to play the reverse side.

Other operations

| To | Do this |
|------------------------|---|
| Stop play | Press  (or TAPE  on the unit). |
| Pause | Press  (or TAPE  on the unit). Press again to resume play. |
| Fast-forward or rewind | Press  or  . |
| Remove a tape | Press TAPE  on the unit in stop mode. |







Note





Do not eject the tape during playback or recording, as this may cause irreparable damage to the tape and cassette holder.





Recording your favorite CD tracks on a tape

— CD-TAPE Synchro Recording



You can record a whole CD on a tape. You can use TYPE I (normal) tape. The recording level is adjusted automatically. Use buttons on the unit for the operation.



- 1 Load a recordable tape.**
- 2 Press FUNCTION repeatedly to switch the function to TAPE.**
- 3 Press DIRECTION repeatedly to select “” to record on one side. Select “” or “” to record on both sides.**
- 4 Press TAPE   repeatedly to select recording side, then press TAPE .**

If you select both sides recording or front side recording, press TAPE   repeatedly to light up the  indicator, then press TAPE .

If you record on the reverse side, press TAPE   repeatedly to light up the  indicator, then press TAPE .

- 5 Press FUNCTION repeatedly to switch the function to CD and load a disc you want to record.**

When you want to record a group from an ATRAC CD or MP3 CD, be sure to press PLAY MODE repeatedly to select , then press  + or – repeatedly to select the desired group before proceeding.

- 6 Press CD SYNCHRO.**
“SYNC”, “REC” and “” (or “”) appear. The tape deck stands by for recording and the CD player pauses for playback.
- 7 Press TAPE II.**
Recording starts.

To stop recording

Press TAPE  (or CD .

Tip

If you stop the recording by pressing CD , the tape stops after making about a 4 seconds blank (unrecorded) space before stopping.

To record a disc by specifying track order

You can record only your favorite CD tracks using Program Play. Between steps 5 and 6, perform steps 2 to 5 of “Creating your own program” (page 13).

Tip

If you select both sides recording and the tape reaches the end of the front side part-way through a track, the entire track is recorded again from the beginning of the reverse side.







Recording on a tape manually









— Manual Recording



You can record just the portions you like from a CD or radio program on a tape.

You can also record from connected components (see “Hooking up optional components” on page 26).

Use buttons on the unit for the operation.



- 1 Load a recordable tape.**
- 2 Press FUNCTION repeatedly to switch the function to TAPE.**
- 3 Press DIRECTION repeatedly to select “” to record on one side. Select “” or “” to record on both sides.**
- 4 Press TAPE   repeatedly to select recording side, then press TAPE .**

If you select both sides recording or front side recording, press TAPE   repeatedly to light up the  indicator, then press TAPE . If you record on the reverse side, press TAPE   repeatedly to light up the  indicator, then press TAPE .
- 5 Press FUNCTION repeatedly to select the desired source to record.**
 - CD: To record from this system’s CD player.
 - TUNER: To record from this system’s tuner.
 - MD: To record from the optional component connected to the ANALOG IN jack.
- 6 Press TAPE  REC.**

“REC” and “” light up and the tape deck stands by for recording.
- 7 Press TAPE , then start playing the desired source to record.**

Recording starts.

Other operations

| To | Do this |
|-----------------|--|
| Stop recording | Press TAPE  . |
| Pause recording | Press TAPE  . |

Notes

- You cannot listen to other sources while recording.
- Recording stops if you change the function to another one.

Tips

- When you record on both sides, be sure to start from the front side. If you start from the reverse side, recording stops at the end of the reverse side.
- For recording from the tuner:
If noise is heard while recording from the tuner, move the respective antenna to reduce the noise.

Sound Adjustment

Adjusting the sound

You can adjust the bass and treble to enjoy more powerful sound.

Generating a more dynamic sound (Dynamic Sound Generator X-tra)

Press DSGX on the unit.

Each time you press the button, the display changes cyclically as follows:

DSGX ON* ↔ DSGX OFF

* "DSGX" lights up.

Adjusting the bass and treble

You can adjust the bass and treble

1 Press EQ repeatedly to select "BASS" or "TREBLE".

Each time you press the button, the display changes as follows:

BASS ↔ TREBLE

2 Press ◀◀ or ▶▶ repeatedly to adjust the level while "BASS" or "TREBLE" appears.

To adjust the bass on the unit

Turn BASS control.

To adjust the treble on the unit

Turn TREBLE control.

To exit the bass and treble settings

Press any button other than EQ, ◀◀ or ▶▶.

Also if you do not perform any operations for a few seconds, the display automatically returns to the original display.

Timer

Falling asleep to music

— Sleep Timer

You can set the system to turn off after a certain time, so that you can fall asleep to music.

Press SLEEP.

Each time you press the button, the minute display (the turn-off time) changes cyclically as follows:

AUTO* → 90MIN → 80MIN → ... → 10MIN → SLEEP OFF

* The system automatically turns off in 100 minutes or after the current disc or tape finishes playing.

Other operations

| To | Press |
|---------------------------------|---|
| Check the remaining time* | SLEEP once. |
| Change the time to turn off | SLEEP repeatedly to select the time you want. |
| Cancel the Sleep Timer function | SLEEP repeatedly until "SLEEP OFF" appears. |

* You cannot check the remaining time if you select "AUTO".

Tip

You can use the Sleep Timer, even if you have not set the clock.

Waking up to music

— Play Timer

You can wake up to music at a preset time. Make sure you have set the clock (see “Setting the clock” on page 10).

Use buttons on the remote for the operation.

1 Prepare the sound source you want to play.

- CD: Load a disc. To start from a specific track, make a program (see “Creating your own program” on page 13).
- Tape: Load a tape (see “Playing a tape” on page 18).
- Tuner: Tune in the preset radio station (see “Listening to a preset station” on page 16).

2 Press VOLUME +/- to adjust the volume.

3 Press CLOCK/TIMER SET.

4 Press ◀◀ or ▶▶ repeatedly to select “PLAY SET”, then press ENTER.

“ON TIME” appears and the hour indication flashes.

5 Set the time to start playing.

Press ◀◀ or ▶▶ repeatedly to set the hour, then press ENTER.

The minute indication flashes.

Press ◀◀ or ▶▶ repeatedly to set the minute, then press ENTER.

6 Set the time to stop playing following the same procedure as step 5.

7 Press ◀◀ or ▶▶ repeatedly until the desired sound source appears.

Each time you press the button, the display changes cyclically as follows:

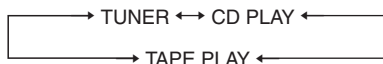

8 Press ENTER.

The start time, the stop time and the sound source appear in turn, then the original display returns.

9 Press I/⏻ to turn off the system.

Other operations

| To | Do this |
|--|---|
| Activate the timer/ Check the setting | 1 Press CLOCK/TIMER SELECT. 2 Press ◀◀ or ▶▶ repeatedly until “PLAY SEL” appears, then press ENTER. |
| Change the setting | Start over from step 1. |
| Cancel the timer | 1 Press CLOCK/TIMER SELECT. 2 Press ◀◀ or ▶▶ repeatedly until “TIMER OFF” appears, then press ENTER. |

Notes

- You cannot activate the Play Timer and the Rec Timer at the same time.
- If you use the Play Timer and the Sleep Timer at the same time, the Sleep Timer has priority.
- Do not operate the system from the time the system turns on until the play starts (about 15 seconds before the preset time).
- If the system is on about 15 seconds before the preset time, the Play Timer will not be activated.
- You cannot use the optional component connected to ANALOG IN jack as the sound source for Play Timer.
- The Play Timer setting remains as long as the setting is not canceled manually.

Timer recording radio programs

— Rec Timer

You can record a preset radio station from a specified time.

To timer record, you must first preset the radio station (see “Presetting radio stations” on page 15) and set the clock (see “Setting the clock” on page 10).

- 1** Tune in the preset radio station (see “Listening to a preset station” on page 16).
- 2** Press **CLOCK/TIMER SET**.
- 3** Press **◀◀** or **▶▶** repeatedly to select “**REC SET**”, then press **ENTER**.
“ON TIME” appears and the hour indication flashes.
- 4** Set the time to start recording.
Press **◀◀** or **▶▶** repeatedly to set the hour, then press **ENTER**.
The minute indication flashes.
Press **◀◀** or **▶▶** repeatedly to set the minute, then press **ENTER**.
- 5** Set the time to stop recording following the same procedure as step 4.
The start time, the stop time, and the preset radio station to be recorded (e.g., “FM 5”) appear in turn, before the original display returns.
- 6** Load a recordable tape.
- 7** Press **TAPE** (or **FUNCTION** repeatedly) to switch the function to **TAPE**.
- 8** Press **DIRECTION** on the unit repeatedly to select “**↔**” to record on one side. Select “**↔**” or “**↔↔**” to record on both sides.

- 9** Press **▶** (or **TAPE ◀▶** on the unit) repeatedly to select recording side, then press **■** (or **TAPE ■** on the unit).

If you select both sides recording or front side recording, press **▶** (or **TAPE ◀▶** on the unit) repeatedly to light up the **▶** indicator, then press **■** (or **TAPE ■** on the unit).

If you record on the reverse side, press **▶** (or **TAPE ◀▶** on the unit) repeatedly to light up the **◀** indicator, then press **■** (or **TAPE ■** on the unit).

- 10** Press **I/⏻** to turn off the system.

Other operations

| To | Do this |
|--|--|
| Activate the timer/ Check the setting | 1 Press CLOCK/TIMER SELECT . 2 Press ◀◀ or ▶▶ repeatedly until “ REC SEL ” appears, then press ENTER . |
| Change the setting | Start over from step 1. |
| Cancel the timer | 1 Press CLOCK/TIMER SELECT . 2 Press ◀◀ or ▶▶ repeatedly until “ TIMER OFF ” appears, then press ENTER . |

Notes

- You cannot activate the Play Timer and the Rec Timer at the same time.
- If you use the Rec Timer and the Sleep Timer at the same time, the Sleep Timer has priority.
- Do not operate the system from the time the system turns on until the recording starts (about 15 seconds before the preset time).
- If the system is on about 15 seconds before the preset time, the Rec Timer will not be activated.
- The volume is reduced to minimum during recording.
- The Rec Timer is canceled automatically after the Rec Timer has been activated.

Display

Turning off the display

— Power Saving Mode

The clock display can be turned off to minimize the amount of power consumed during standby (Power Saving Mode).

Press DISPLAY repeatedly while the system is off until the clock display disappears.

To cancel Power Saving Mode

Press DISPLAY while the system is off. Each time you press the button, the display switches cyclically as follows:

Clock display* → No display (Power Saving Mode)

* The clock is displayed only if you set the clock.

Note

You cannot perform the following operations in Power Saving Mode.

- setting the clock
- changing the AM tuning interval (except for European model)
- changing the CD power manage function

Tips

- STANDBY indicator lights up even in Power Saving Mode.
- The timer continues to operate in Power Saving Mode.

Viewing information about the disc in the display

You can check the playing time and remaining time of the current track or that of the disc. When a CD-TEXT disc, ATRAC CD or MP3 CD is loaded, you can also check the information recorded on disc, such as the titles.

Checking the remaining time and titles

Press DISPLAY during Normal Play.

Each time you press the button, the display changes cyclically as follows:

Current track number and elapsed playing time → Current track number and remaining time or “_ _ _ _”¹⁾ → Remaining time of the disc²⁾ or “_ _ _ _”³⁾ → Track title (CD-TEXT disc⁴⁾, ATRAC CD and MP3 CD⁵⁾ only → Group name³⁾⁵⁾ → Clock display (for eight seconds) → Bass level (for eight seconds) → Treble level (for eight seconds)

¹⁾ For MP3 CDs

²⁾ “_ _ _ _” appears in Program Play mode.

³⁾ For ATRAC CDs and MP3 CDs

⁴⁾ When the disc contains more than 20 tracks, CD-TEXT is not displayed from track 21 on.

⁵⁾ When you play back a track with an ID3 tag ver. 1 or ver. 2, the ID3 tag information appears. The ID3 tag displays the track title, album name and artist name information.

Note

When fast forward or fast reverse is performed, elapsed playing time and remaining time of the track may not be displayed accurately.

Checking the total playing time and titles

Press **DISPLAY** in stop mode.

Each time you press the button, the display changes cyclically as follows:

■ Normal Play mode

TOC display¹⁾ or total group number of the disc²⁾ or total track number of the current group²⁾ → Disc title³⁾ or volume label²⁾ or group name²⁾ → Clock display (for eight seconds) → Bass level (for eight seconds) → Treble level (for eight seconds)

¹⁾ TOC = Table of Contents; displays total number of tracks on the disc, and total playing time of the disc

²⁾ For ATRAC CDs and MP3 CDs (group names or volume label may not be displayed depending on the play mode).

³⁾ For CD-TEXT discs (certain characters cannot be displayed). Depending on the disc, some CD-TEXT information may not appear.

■ Program Play mode

The last track number of the program and the total playing time → Total track number of the program (for eight seconds) → Disc title¹⁾ or volume label²⁾ → Clock display (for eight seconds) → Bass level (for eight seconds) → Treble level (for eight seconds)

¹⁾ For CD-TEXT discs (certain characters cannot be displayed). Depending on the disc, some CD-TEXT information may not appear.

²⁾ For ATRAC CDs and MP3 CDs.

Viewing the tuner information in the display

Press **DISPLAY** while listening to the radio.

Each time you press the button, the display changes cyclically as follows:

Station name¹⁾ → Preset number²⁾ and frequency → Clock display (for eight seconds) → Bass level (for eight seconds) → Treble level (for eight seconds)

¹⁾ European model only

²⁾ Preset number is displayed only if you preset radio stations (page 15).

Optional Components

Hooking up optional components

To enhance your system, you can connect optional components. Refer to the operating instructions provided with each component.

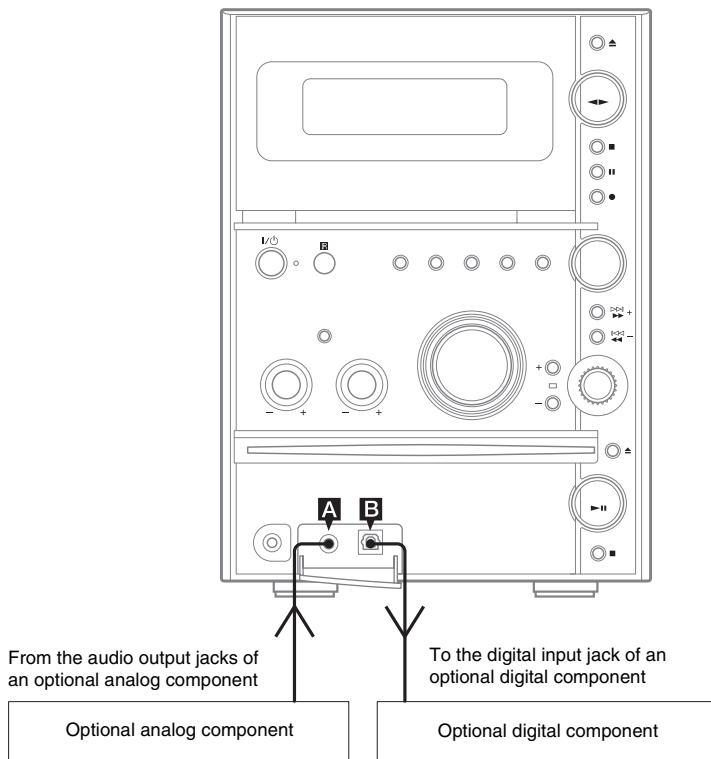

A ANALOG IN jack

Use audio cord (not supplied) to connect an optional analog component (MiniDisc player/recorder or Portable Audio player, etc.) to this jack. You can then record or listen to the sound from the component through this system.

B CD DIGITAL OUT jack

Use a digital optical cord (square, not supplied) to connect an amplifier, MiniDisc player/recorder or DAT deck with a digital optical input jack. Sound is then output when the system function is set to CD. If the jack is covered with a cap, remove it before use.

Notes

- There is no digital audio output from this jack during playback of ATRAC3plus/MP3 tracks.
- You cannot make a digital recording of a copy guarded disc using a digital component connected to this system. Also, playback may not be possible depending on the connected component.
- Before connecting or disconnecting the audio cord (not supplied), press VOLUME – repeatedly (or turn the VOLUME control on the unit counterclockwise) to turn down the volume.

Listening to audio from a connected component

- 1 Connect the audio cord (not supplied).**
See “Hooking up optional components” on page 26.
- 2 Press FUNCTION repeatedly until “MD” appears.**
- 3 Start playing the connected component.**

Recording audio from a connected component

- 1 Connect audio cord (not supplied).**
See “Hooking up optional components” on page 26.
- 2 Start recording manually.**
See “Recording on a tape manually” on page 20.

Recording on a connected component

- 1 Connect the digital optical cord (not supplied).**
- 2 Start recording with the connected digital component (MiniDisc player/recorder, etc.).**
Refer to the operating instructions provided with the connected component.

Note

You can digitally record from the discs only. However, you cannot record from copy prohibited discs and ATRAC3plus/MP3 tracks.

Troubleshooting

Problems and remedies

Should you encounter a problem with your system, do the following:

- 1 Make sure the mains lead and speaker cords are correctly and firmly connected.
- 2 Find your problem in the troubleshooting checklist below and take the indicated corrective action.

If the problem persists after doing all of the above, consult your nearest Sony dealer.

When the STANDBY indicator flashes

Immediately unplug the mains lead and check the following items.

- If your system has a voltage selector, is the voltage selector set to the correct voltage? Check the voltage for your region, then make sure the voltage selector is set correctly.
- Are the + and – speaker cords short-circuited?
- Are you using the supplied speakers?
- Is anything blocking the ventilation holes on the rear of the system?

Check all the above items and fix any problems found. After STANDBY indicator stops flashing, reconnect the mains lead and turn on the system. If the indicator still flashes, or if the cause of the problem cannot be found even after checking all the above items, consult your nearest Sony dealer.

General

“- -: -” appears in the display.

- A power interruption has occurred. Set the clock (page 10) and timer settings (pages 22 and 23) again.

The clock setting/radio presetting/timer is canceled.

- Redo the following:
 - “Setting the clock” (page 10)
 - “Presetting radio stations” (page 15)
 - “Waking up to music” (page 22)
 - “Timer recording radio programs” (page 23)

There is no sound.

- Press VOLUME + or turn VOLUME control on the unit clockwise.
- Make sure the headphones are not connected.
- Check the speaker connections (page 9).
- There is no audio output during Rec Timer.

Sound comes from one channel, or unbalanced left and right volume.

- Place the speakers as symmetrically as possible.
- Connect the supplied speakers.

There is severe hum or noise.

- Move the system away from the source of noise.
- Connect the system to a different mains.
- Install a noise filter (commercially available) to the mains lead.

The timer cannot be set.

- Set the clock again (page 10).

The timer does not function.

- Check the timer setting and set the correct time (pages 22 and 23).
- Cancel the Sleep Timer function (page 21).
- Make sure the clock is correctly set (page 10).

The color irregularity on a TV screen persists.

- Turn off the TV set once, then turn it on after 15 to 30 minutes. If the color irregularity still persists, place the speakers farther away from the TV set.

The remote does not function.

- Remove the obstacle.
- Move the remote closer to the system.
- Point the remote at the system’s sensor.
- Replace the batteries (R6/size AA).
- Locate the system away from the fluorescent light.

The system can not be turned on even though you have pressed I/⏻.

- Make sure the mains lead is connected to wall outlet.

CD player

“LOCKED” appears.

- Contact your Sony dealer or local authorized Sony service facility.

The disc does not eject.

- You cannot eject the disc during CD Synchro Recording. Press CD ■ on the unit to cancel the CD Synchro Recording, then press CD ▲ on the unit to eject the disc.
- Consult your nearest Sony dealer.

Play does not start.

- Check whether a disc is loaded.
- Wipe the disc clean (page 32).
- Replace the disc.
- Load the disc that this system can play (page 6).
- Load the disc correctly.
- Load the disc with the label side up.
- Remove the disc and wipe away the moisture on the disc, then leave the system turned on for a few hours until the moisture evaporates.
- Press ► (or CD ►|| on the unit) to start play.

Disc access takes a long time.

- Set “CD POWER” and “ON” by CD power manage function (page 16).

The sound skips.

- Wipe the disc clean (page 32).
- Replace the disc.
- Try moving the system to a place without vibration (e.g., on top of a stable stand).
- Try moving the speakers away from the system, or placing them on separate stands. When you listen to a track with bass sounds at high volume, the speaker vibration may cause the sound to skip.

Play does not start from the first track.

- Press PLAY MODE repeatedly until both “PGM” and “SHUF” disappear to return to Normal Play.

Tracks on the ATRAC CD or MP3 CD cannot be played back.

- Recording was not performed according to the ISO9660 Level 1 or Level 2 format, or Joliet in the expansion format.
- The MP3 file does not have the extension “.MP3”.
- The data is not stored in ATRAC3plus/MP3 format.
- Discs containing MP3 files other than MPEG 1, 2, 2.5 Audio Layer-3 files cannot be played.

Tracks on the ATRAC CD or MP3 CD take longer to play back than others.

- After the system reads all tracks on the disc, playback may take more time than usual if:
 - the number of groups or tracks on the disc is very large.
 - the album and track organization structure is very complex.

The group name, track title, ID3 tag information and the CD-TEXT characters do not appear correctly.

- Use a disc that conforms with ISO9660 Level 1, Level 2 or Joliet in the expansion format.
- The disc ID3 tag is not ver. 1 nor ver. 2.
- The characters that can be displayed by this system are as follows:
 - Upper cases (A to Z)
 - Numbers (0 to 9)
 - Symbols (‘<> * + , - / [\] _)Other characters may not be displayed correctly.

Tuner

Severe hum or noise/stations cannot be received.

- Set the proper band and frequency (page 15).
- Connect the antenna properly (page 9).
- Find a place and an orientation that provide good reception, then set up the antenna again. If you cannot obtain good reception, we recommend you connect a commercially available external antenna.
- The supplied FM lead antenna receives signals along its entire length, so make sure you extend it fully.
- Locate the antennas as far away from the speaker cords as possible.
- Consult your nearest Sony dealer if the supplied AM antenna has come off the plastic stand.
- Try turning off surrounding electrical equipment.
- Set “CD POWER” and “OFF” by CD power manage function (page 16).

A stereo FM program cannot be received in stereo.

- Press FM MODE until “STEREO” appears in the display.

Tape deck

The tape does not record or play, or there is a decrease in sound level.

- The heads are dirty. Clean them (page 33).
- The record/playback heads are magnetized. Demagnetize them (page 33).

The tape does not erase completely.

- The record/playback heads are magnetized. Demagnetize them (page 33).

There is excessive wow or flutter, or the sound drops out.

- The capstans in the tape deck are dirty. Clean them (page 33).

Noise increases or the high frequencies are erased.

- The record/playback heads are magnetized. Demagnetize them (page 33).

The tape does not record.

- No cassette is loaded. Load a cassette.
 - The tab has been removed from the cassette. Cover the broken tab with adhesive tape (page 33).
 - The tape has wound to the end.
-

Optional components

There is no sound.

- Refer to General item “There is no sound.” (page 28) and check the condition of the system.
- Connect the component properly (page 26) while checking:
 - if the cords are connected properly.
 - if the cord plugs are firmly inserted all the way.
- Turn on the connected component.
- Refer to the operating instructions supplied with the connected component and start playing.
- Press FUNCTION repeatedly to select “MD” (page 27).

The sound is distorted.

- Set the volume of the connected component lower.
-

If the system still does not operate properly after performing the above measures, reset the system as follows:

Use buttons on the unit for the operation.

- 1 Disconnect the mains lead.
- 2 Reconnect the mains lead.
- 3 Press I/⏻ to turn on the system.
- 4 Press TAPE ■, I/⏻ and DISPLAY.

The system is reset to the factory settings. You should set the settings you made, such as the preset stations, clock, and timer.

Messages

One of the following messages may appear or flash in the display during operation.

CD

NO DISC

There is no disc in the player.

NO STEP

All of the programmed tracks have been erased.

OVER

You have reached the end of the disc while pressing **▶▶** during playback or pause.

PUSH STOP

You pressed PLAY MODE during playback.

STEP FULL

You tried to program 25 or more tracks (steps).

Tuner

COMPLETE

The preset operation ended normally.

TAPE

NO TAB

You cannot record the tape because the tab has been removed from the cassette.

NO TAPE

There is no tape in the tape deck.

Timer

PUSH SELECT

You tried to set the clock or timer during timer operation.

SET CLOCK

You tried to select the timer when the clock is not set.

SET TIMER

You tried to select the timer when the Play Timer or Rec Timer are not set.

TIME NG

The Play Timer or Rec Timer start and end times are set to the same time.

Additional Information

Precautions

On operating voltage

Before operating the system, check that the operating voltage of your system is identical with the voltage of your local power supply.

On safety

- The unit is not disconnected from the AC power source (mains) as long as it is connected to the wall outlet, even if the unit itself has been turned off.
- Unplug the system from the wall outlet (mains) if it is not to be used for an extended period of time. To disconnect the power cord (mains lead), pull it out by the plug. Never pull the cord itself.
- Should any solid object or liquid fall into the system, unplug the system and have it checked by qualified personnel before operating it any further.
- AC power cord must be changed only at the qualified service shop.

On placement

- Do not place the system in an inclined position.
- Do not place the system in locations where it is;
 - Extremely hot or cold
 - Dusty or dirty
 - Very humid
 - Subject to vibrations
 - Subject to direct sunlight.
- Use caution when placing the unit or speakers on surfaces that have been specially treated (with wax, oil, polish, etc.) as staining or discoloration of the surface may result.

On heat buildup

- Although the system heats up during operation, this is not a malfunction.
- Place the system in a location with adequate ventilation to prevent heat build-up in the system.
- If you continuously use this system at a high volume, the cabinet temperature of the top, side and bottom rises considerably. To avoid burning yourself, do not touch the cabinet.
- To prevent a malfunction, do not cover the ventilation hole.

On the speaker system

This speaker system is not magnetically shielded and the picture on TV sets may become magnetically distorted. In such a case, turn off the power of the TV set once, and after 15 to 30 minutes turn it on again.

If there seems to be no improvement, locate the speaker system further away from the TV set.

On operation

- If the system is brought directly from a cold to a warm location, or is placed in a very damp room, moisture may condense on the lens inside the CD player. Should this occur, the system will not operate properly. Remove the disc and leave the system turned on for about an hour until the moisture evaporates.
- When you move the system, take out any disc.

If you have any questions or problems concerning your system, please consult your nearest Sony dealer.

Notes on discs

- Before playing, clean the disc with a cleaning cloth. Wipe the disc from the center out.
- Do not use solvents such as benzine, thinner, commercially available cleaners or anti-static spray intended for vinyl LPs.
- Do not expose the disc to direct sunlight or heat sources such as hot air ducts, nor leave it in a car parked in direct sunlight.
- Do not use discs encircled with a protection ring. This may cause a malfunction to the system.
- When using discs that have glue or similar tacky substance on the label side of the disc or that used a special ink when the label was printed, there is a chance that the disc or label may become attached to parts inside this unit. When this occurs, it may not be possible to remove the disc, and may also cause this unit to malfunction. Be sure to check that the label side of the disc is not sticky before using. The following types of disc should not be used:
 - Rental or used discs with attached seals where the glue extends beyond the seal. The perimeter of the seal on the disc is tacky.
 - Discs that have labels printed using a special ink that feels tacky when touched.
- Discs with non-standard shapes (e.g., heart, square, star) cannot be played on this unit. Attempting to do so may damage the unit. Do not use such discs.

Cleaning the cabinet

Clean the cabinet, panel and controls with a soft cloth slightly moistened with mild detergent solution. Do not use any type of abrasive pad, scouring powder or solvent such as thinner, benzine or alcohol.

To save a tape permanently

To prevent a tape from being accidentally recorded over, break off the cassette tab from side A or B as illustrated.

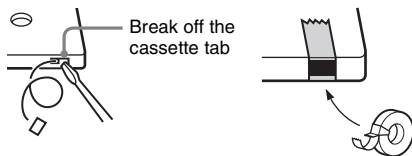

If you later want to reuse the tape for recording, cover the broken tab with adhesive tape.

Before placing a cassette in the tape deck

Take up any slack in the tape. Otherwise, the tape may get entangled in the parts of the tape deck and become damaged.

When using a tape longer than 90 minutes

The tape is very elastic. Do not change the tape operations such as play, stop, and fast-winding frequently. The tape may get entangled in the tape deck.

Cleaning the tape heads

Clean the tape heads after every 10 hours of use. Be sure to clean the tape heads before you start an important recording or after playing an old tape. Use a separately sold dry-type or wet-type cleaning cassette. For details, refer to the instructions of the cleaning cassette.

Demagnetizing the tape heads

Demagnetize the tape heads and the metal parts that have contact with the tape after every 20 to 30 hours of use with a separately sold demagnetizing cassette. For details, refer to the instructions of the demagnetizing cassette.

Specifications

Main unit

Amplifier section

European model:

DIN power output (rated): 60 + 60 watts (4 ohms at 1 kHz, DIN)

Continuous RMS power output (reference): 75 + 75 watts (4 ohms at 1 kHz, 10% THD)

Other models:

The following measured at AC 220 – 240 V, 50/60 Hz
DIN power output (rated) 60 + 60 watts

(4 ohms at 1 kHz, DIN)
Continuous RMS power output (reference)
75 + 75 watts
(4 ohms at 1 kHz, 10% THD)

Inputs

ANALOG IN (stereo mini jack):
Sensitivity 250 mV,
impedance 47 kilohms

Outputs

CD DIGITAL OUT: Optical Wavelength:
660 nm
PHONES (stereo mini jack):
accepts headphones with
an impedance of 8 ohms or
more
SPEAKER:
accepts impedance of
4 ohms

CD player section

System Compact disc and digital audio system
Laser Diode Properties Emission duration:
continuous
Laser Output: Less than 44.6 μ W
(This output is the value measurement at a distance of 200 mm from the objective lens surface on the Optical Pick-up Block with 7 mm aperture)

Frequency response 2 Hz – 20 kHz (\pm 0.5 dB)
Wavelength 770 – 810 nm

Tape deck section

| | |
|--------------------|--|
| Recording system | 4-track 2-channel stereo |
| Frequency response | 50 – 13,000 Hz (± 3 dB), using Sony TYPE I cassettes |
| Wow and flutter | $\pm 0.15\%$ W. Peak (IEC) 0.1% W. RMS (NAB) $\pm 0.2\%$ W. Peak (DIN) |

Tuner section

FM stereo, FM/AM superheterodyne tuner

FM tuner section

| | |
|--------------|-----------------------------------|
| Tuning range | 87.5 – 108.0 MHz (50 kHz step) |
|--------------|-----------------------------------|

| | |
|------------------------|--------------------|
| Antenna | FM lead antenna |
| Antenna terminals | 75 ohms unbalanced |
| Intermediate frequency | 10.7 MHz |

AM tuner section

| | |
|------------------|--|
| Tuning range | 531 – 1,602 kHz (with the tuning interval set at 9 kHz) |
| European, model: | 531 – 1,602 kHz (with the tuning interval set at 9 kHz) |
| Other models: | 530 – 1,710 kHz (with the tuning interval set at 10 kHz) |

| | |
|------------------------|---------------------------|
| Antenna | AM loop antenna |
| Antenna terminals | External antenna terminal |
| Intermediate frequency | 450 kHz |

Speaker

| | |
|--------------------|-----------------------------------|
| Speaker system | 2-way, bass-reflex type |
| Speaker units | |
| Woofer: | 13 cm dia., cone type |
| Tweeter: | 2.5 cm dia., soft-dome- type |
| Nominal impedance | 4 ohms |
| Dimensions (w/h/d) | Approx. 160 × 240 × 265 mm |
| Mass | Approx. 3.2 kg net per speaker |

General

| | |
|--------------------------------------|---|
| Power requirements | |
| European model: | 230 V AC, 50/60 Hz |
| Other models: | 220 – 240 V AC, 50/60 Hz |
| Power consumption | |
| European model: | 60 watts 0.3 watts (in Power Saving mode) |
| Other models: | 60 watts |
| Dimensions (w/h/d) (excl. speakers): | Approx. 175 × 240 × 295 mm |

Mass (excl. speakers)

Amplifier/Tuner/Tape/CD section:

Approx. 3.8 kg

| | |
|----------------------|--|
| Supplied accessories | Remote Commander (1) R6 (Size AA) batteries (2) AM loop antenna (1) FM lead antenna (1) Speaker pads (8) CD-ROM (SonicStage) (1) SonicStage Installation/ Operating Guide (1) |
|----------------------|--|

US and foreign patents licensed from Dolby Laboratories.

Design and specifications are subject to change without notice.



- Standby power consumption: 0.3 W
- Halogenated flame retardants are not used in the certain printed wiring boards.
- Lead-free solder is used for soldering certain parts.
- Halogenated flame retardants are not used in cabinets.

List of button locations and reference pages

How to use this page

Use this page to find the location of buttons and other parts of the system that are mentioned in the text.

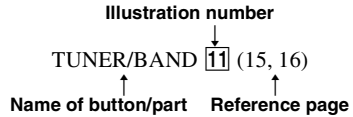

Main unit

ALPHABETICAL ORDER

A - I

- ANALOG IN jack **22** (26)
- BASS control **26** (21)
- CANCEL **20** (12)
- CD DIGITAL OUT jack **23** (26)
- CD SYNCHRO **10** (19)
- DIRECTION **28** (18, 19, 20, 23)
- Disc slot **24** (11)
- DISPLAY **29** (17, 24, 25, 30)
- Display window **3**
- DSGX **27** (21)
- FM MODE **9** (17)
- FUNCTION **12** (11, 13, 15, 16, 18, 19, 20, 23, 27)

J - Z

- Jog dial **14** (12, 14)
- PHONES jack **21**
- PLAY MODE **28** (11, 14, 19)
- PUSH ENTER **15** (12, 14)
- Remote sensor **2**
- REPEAT **9** (13)
- TREBLE control **25** (21)
- TUNER/BAND **11** (15, 16)
- TUNING MODE **28** (15, 16)
- TUNING +/- **13** (15, 16)
- VOLUME control **19** (26)

BUTTON DESCRIPTIONS

- I/⏻ (power) **1** (9, 16, 30)
- TAPE ▲ (eject) **4** (18)
- TAPE ◀▶ (play) **5** (18, 19, 23)
- TAPE ■ (stop) **6** (18, 19, 23, 30)
- TAPE || (pause) **7** (18, 19)
- TAPE ● REC (record) **8** (20)
- ◀◀◀/▶▶▶ (rewind/fast forward, go back/go forward) **13** (12, 18, 21, 23)
- 📁 +/- (select group) **16** (12, 19)
- CD ▲ (eject) **17** (12)
- CD ▶▶|| (play) **18** (11)
- CD ■ (stop) **20** (10, 12, 16, 19)

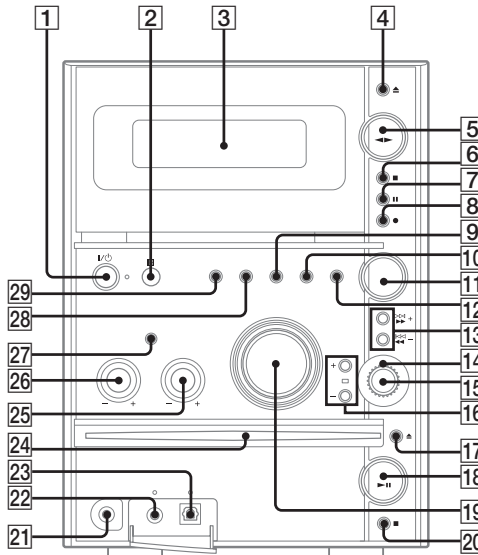

Remote control

ALPHABETICAL ORDER

A - E

CD **16** (11, 13)
 CLEAR **13** (14)
 CLOCK/TIMER SELECT **2**
 (22, 23)
 CLOCK/TIMER SET **3** (10, 22,
 23)
 DISPLAY **19** (17, 24, 25)
 ENTER **9** (10, 13, 15, 22, 23)
 EQ **12** (21)

F - Z

FM MODE **4** (17)
 FUNCTION **6** (11, 13, 15, 16,
 18, 23, 27)
 PLAY MODE **18** (11, 13)
 REPEAT **4** (13)
 SLEEP **20** (21)
 TAPE **15** (18, 23)
 TUNER BAND **5** (15, 16)
 TUNER MEMORY **17** (15)
 TUNING MODE **18** (15, 16)
 VOLUME +/- **10** (22, 26)

BUTTON DESCRIPTIONS

I/⏻ (power) **1** (9, 22)
 ◀◀/▶▶ (rewind/fast forward)
7 (12, 18)
 ▶ (play) **8** (11, 18, 23)
 || (pause) **8** (12, 18)
 ■ (stop) **8** (12, 18)
 📁 +/- (select group) **11** (12)
 ◀◀/▶▶ (go back/go forward)
14 (10, 12, 21, 22)
 +/- (tuning) **14** (15)

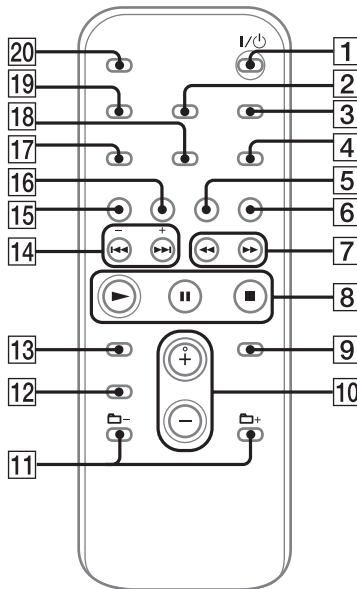

Printed on 100 % recycled paper using VOC (Volatile Organic Compound)-free vegetable oil based ink.