

SONY

2-670-405-15(1)

Mini Hi-Fi Component System

Operating Instructions

GB

Owner's Record

The model and serial numbers are located on the rear of the unit. Record these numbers in the space provided below. Refer to them whenever you call upon your Sony dealer regarding this product.
Model No. _____ Serial No. _____

MHC-EC70

© 2006 Sony Corporation Printed in China
<http://www.sony.net/>



WARNING



This symbol is intended to alert the user to the presence of uninsulated "dangerous voltage" within the product's enclosure that may be of sufficient magnitude to constitute a risk of electric shock to persons.



This symbol is intended to alert the user to the presence of important operating and maintenance (servicing) instructions in the literature accompanying the appliance.

To reduce the risk of fire or electric shock, do not expose this apparatus to rain or moisture.

CAUTION

The use of optical instruments with this product will increase eye hazard.

For customers in the U.S.A.

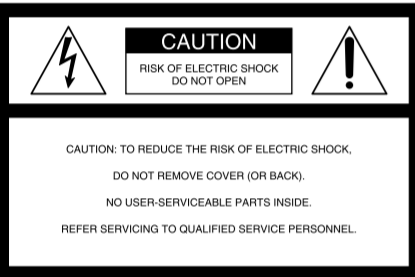

WARNING

This equipment has been tested and found to comply with the limits for a Class B digital device, pursuant to Part 15 of the FCC Rules. These limits are designed to provide reasonable protection against harmful interference in a residential installation. This equipment generates, uses, and can radiate radio frequency energy and, if not installed and used in accordance with the instructions, may cause harmful interference to radio communications. However, there is no guarantee that interference will not occur in a particular installation. If this equipment does cause harmful interference to radio or television reception, which can be determined by turning the equipment off and on, the user is encouraged to try to correct the interference by one or more of the following measures:

- Reorient or relocate the receiving antenna.
- Increase the separation between the equipment and receiver.
- Connect the equipment into an outlet on a circuit different from that to which the receiver is connected.
- Consult the dealer or an experienced radio/TV technician for help.

This device complies with Part 15 of the FCC Rules. Operation is subject to the following two conditions: (1) This device may not cause harmful interference, and (2) this device must accept any interference received, including interference that may cause undesired operation.

You are cautioned that any changes or modifications not expressly approved in this manual could void your authority to operate this equipment.

U.S.A., Canadian and Australian models only



ENERGY STAR® is a U.S. registered mark. As an ENERGY STAR® partner, Sony Corporation has determined that this product meets the ENERGY STAR® guidelines for energy efficiency.

Note on DualDiscs

A DualDisc is a two sided disc product which mates DVD recorded material on one side with digital audio material on the other side. However, since the audio material side does not conform to the Compact Disc (CD) standard, playback on this product is not guaranteed.

Music discs encoded with copyright protection technologies

This product is designed to playback discs that conform to the Compact Disc (CD) standard. Recently, various music discs encoded with copyright protection technologies are marketed by some record companies. Please be aware that among those discs, there are some that do not conform to the CD standard and may not be playable by this product.

MPEG Layer-3 audio coding technology and patents licensed from Fraunhofer IIS and Thomson.

Basic Operations

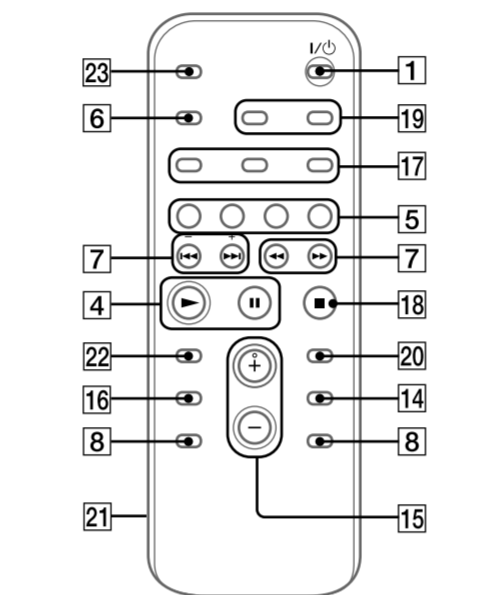
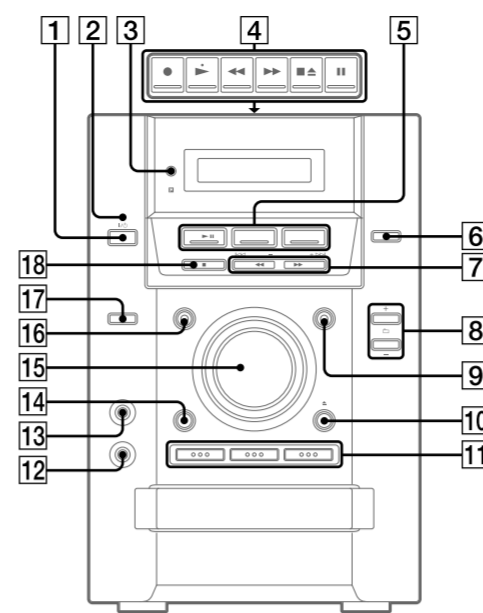

Adjusting the sound

To adjust the volume

Press VOLUME +/- on the remote (or turn the VOLUME control on the unit) [15].

To add a sound effect

To	Press
Generate a more dynamic sound (Dynamic Sound Generator X-tra)	DSGX [9] on the unit.
Set the sound effect	EQ [16].

Playing a CD/MP3 disc

1 Select the CD function.

Press CD on the remote (or FUNCTION repeatedly) [5].

2 Place a disc.

Press \blacktriangle (open/close) [10] on the unit, and place a disc with the label side up on the disc tray. To place additional discs, slide the disc tray with your finger as shown below.

To close the disc tray, press \blacktriangle (open/close) [10] on the unit.

Do not force the disc tray closed with your finger, as this may damage the unit.



3 Select a disc.

If the discs are currently stopped, press DISC SKIP on the remote (or DISC SKIP/EX-CHANGE on the unit) [14]. To change discs while in other functions, press DISC 1 - 3 [11] on the unit.

4 Start playback.

Press \blacktriangleright (play) [4] (or CD \blacktriangleright [5] (play/pause) [5] on the unit).

To exchange other discs during playback, press DISC SKIP/EX-CHANGE [14] on the unit.

To	Press
Pause playback	\parallel (pause) [4] on the remote (or CD \blacktriangleright [5] on the unit). To resume play, press it again.
Stop playback	\blacksquare (stop) [18].
Select a folder on an MP3 disc	\square +/- [8].
Select a track or file	\blacktriangleleft / \blacktriangleright (go back/go forward) on the remote (\blacktriangleleft / \blacktriangleright on the unit) [7].
Find a point in a track or file	Hold down \blacktriangleleft / \blacktriangleright (rewind/fast forward) [7] during playback, and release it at the desired point.
Select Repeat Play	REPEAT [17] on the remote repeatedly until "REP" or "REPI" appears.

To change the play mode

Press PLAY MODE [17] repeatedly while the player is stopped. You can select normal play (no display for all discs or "1 DISC" for a disc or "1" for all MP3 files in the folder on the disc), shuffle play ("SHUF" for all discs shuffle, "1 DISC SHUF" for one disc shuffle or "1" SHUF*" for folder shuffle), or program play ("PGM").

* When playing a CD-DA disc, \square (SHUF) Play performs the same operation as 1 DISC (SHUF) Play.

Notes on Repeat Play

- All tracks or files on a disc are played repeatedly up to five times.
- MP3 files are played back in the order that they are recorded on the disc.
- "REP1" indicates that a single track or file is repeated until you stop it.

Notes on playing MP3 discs

- Do not save other types of tracks or files or unnecessary folders on a disc that has MP3 files.
- Folders that have no MP3 files are skipped.
- MP3 files are played back in the order that they are recorded on the disc.
- The system can only play MP3 files that have a file extension of ".MP3".
- If there are files on the disc that have the ".MP3" file extension, but that are not MP3 files, the unit may produce noise or may malfunction.
- The maximum number of:
 - folders is 150 (including the root folder).
 - MP3 files is 255.
 - MP3 files and folders that can be contained on a single disc is 256.
 - folder levels (the tree structure of files) is eight.
- Compatibility with all MP3 encoding/writing software, recording device, and recording media cannot be guaranteed. Incompatible MP3 discs may produce noise or interrupted audio or may not play at all.

Before using the system

To use the remote

Slide and remove the battery compartment lid [21], and insert the two R6 (size AA) batteries (not supplied), \bullet side first, matching the polarities shown below.

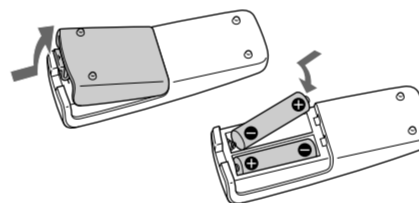

Notes on using the remote

- With normal use, the batteries should last for about six months.
- Do not mix an old battery with a new one or mix different types of batteries.
- If you do not use the remote for a long period of time, remove the batteries to avoid damage from battery leakage and corrosion.

To set the clock

1 Turn on the system.

Press I/ON (power) [1].

2 Select the clock set mode.

Press CLOCK/TIMER SET [19] on the remote. If the current mode appears on the display, press \blacktriangleleft / \blacktriangleright [7] on the remote repeatedly to select "CLOCK," and then press ENTER [20] on the remote.

3 Set the time.

Press \blacktriangleleft / \blacktriangleright [7] on the remote repeatedly to set the hour, and then press ENTER [20] on the remote. Use the same procedure to set the minutes.

The clock settings are lost when you disconnect the power cord or if a power failure occurs.

Selecting a music source

Press the following buttons (or press FUNCTION [5] repeatedly).

To select	Press
CD	CD [5] on the remote.
Tuner	TUNER/BAND [5].
Tape	TAPE [5] on the remote.
Component* (connected using an audio cord)	FUNCTION [5] repeatedly until "AUDIO IN" appears.

* If the component has the AVLS (Automatic Volume Limiter System) or BASS BOOST function, turn off the function to avoid distorted sound from the speakers.

Hooking up the system securely

Antennas

Keep the antennas away from the speaker cords to avoid picking up noise.

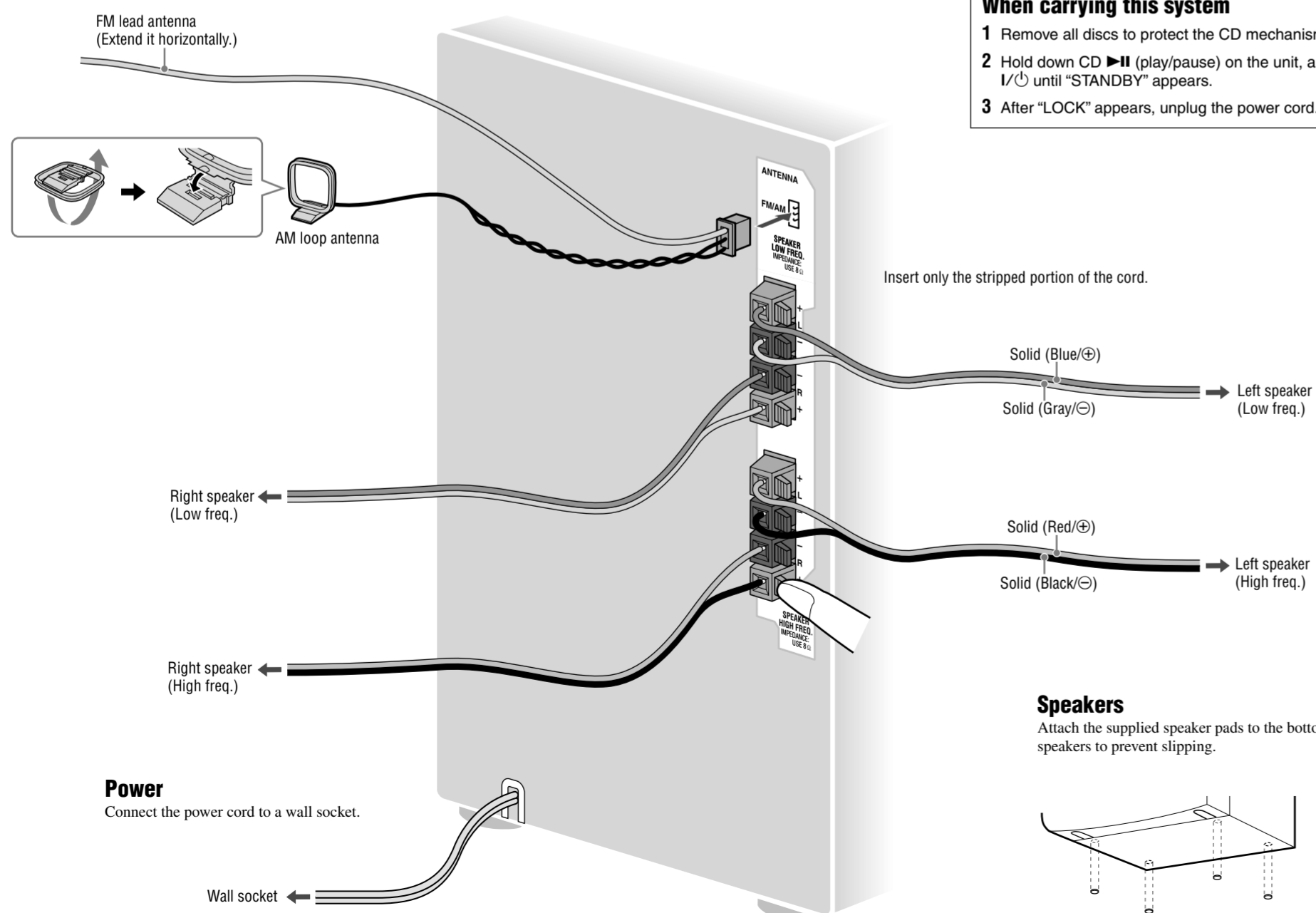

When carrying this system
 1 Remove all discs to protect the CD mechanism.
 2 Hold down CD \blacktriangleright [5] (play/pause) on the unit, and press I/ON until "STANDBY" appears.
 3 After "LOCK" appears, unplug the power cord.

Speakers

Attach the supplied speaker pads to the bottom of the speakers to prevent slipping.

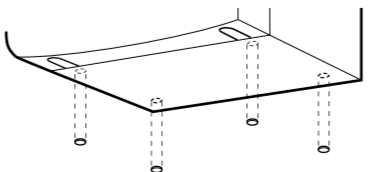

Notes on playing multisession discs

- If the disc begins with a CD-DA (or MP3) session, it is recognized as a CD-DA (or MP3) disc, and playback continues until another session is encountered.
- A disc with a mixed CD format is recognized as a CD-DA (audio) disc.

Listening to the radio

1 Select "FM" or "AM."

Press TUNER/BAND [5] repeatedly.

2 Select the tuning mode.

Press TUNING MODE [17] repeatedly until "AUTO" appears.

3 Tune in the desired station.

Press +/- on the remote (or TUNING + or - on the unit) [7]. Scanning stops automatically when a station is tuned in.

To stop automatic scanning

Press \blacksquare (stop) [18].

To tune in a station with a weak signal

Press TUNING MODE [17] repeatedly until "MANUAL" appears, and then press +/- on the remote repeatedly (or TUNING + or - on the unit) [7] to tune in the desired station.

To reduce static noise on a weak FM stereo station

Press FM MODE [17] on the remote repeatedly until "MONO" appears to turn off stereo reception.

Playing a tape

Use buttons on the unit for the operation.

1 Select a tape function.

Press FUNCTION repeatedly (or TAPE on the remote) [5].

2 Insert a tape.

Press \blacktriangle (stop/eject) [4] on the unit, and insert the tape into the cassette holder. Make sure there is no slack in the tape to avoid damaging the tape or the tape deck.

3 Start playback.

Press \blacktriangleright (play) [4] on the unit.

To	Press
Pause playback	\parallel (pause) [4] on the unit. To resume play, press it again.
Stop playback	\blacktriangle (stop/eject) [4] on the unit.
Rewind or fast forward*	\blacktriangleleft / \blacktriangleright [4] on the unit.

* Be sure to press \blacktriangle (stop/eject) [4] on the unit after the tape has been wound or rewound to the end.

Note

Do not turn off the system during playback or recording.

Changing the display

To change	Press
Information on the display ¹⁾	DISPLAY [6] repeatedly when the system is on.
Display mode (Clock)	DISPLAY [6] when the system is off ²⁾ . The clock is displayed for eight seconds.

¹⁾ For example, you can view CD/MP3 disc information, such as the track or file number or folder name during normal play, or the total play time while the player is stopped.
²⁾ The STANDBY indicator [2] lights up when the system is turned off.

Notes on the display information

- The following are not displayed:
 - total playing time for a CD-DA disc depending on the play mode.
 - total playing time for an MP3 disc.
 - remaining playing time for a track and an MP3 file.
- The following are not displayed correctly:
 - elapsed playing time of an MP3 file encoded using a VBR (variable bit rate).
 - folder and file names that do not follow either the ISO9660 Level 1, Level 2 or Joliet in the expansion format.
- The following are displayed:
 - ID3 tag information for MP3 files when ID3 version 1 and version 2 tags are used.
 - up to 15 characters of ID3 tag information using uppercase letters (A to Z), numbers (0 to 9), and symbols (* < > * + , - / @ [\] _).

Using optional audio components

To connect an optional headphones

Connect headphones to the PHONES jack [12] on the unit.

To connect an optional component

Connect additional audio source components to the AUDIO IN jack [13] on the unit using an audio analog cord (not supplied). Turn down the volume on the system, and then select the AUDIO IN function.

Other Operations

Creating your own CD program (Program Play)

Use buttons on the remote to create your own program.

1 Press **CD** [5] to select the CD function.

2 Press **PLAY MODE** [17] repeatedly until “PGM” appears while the player is stopped.

3 Press **DISC SKIP** [14] to select a disc.

4 Press **⏮️/▶️** (or **⏪**/**⏩**) on the unit) [7] repeatedly until the desired track number appears.

When programing MP3 files, press **⏮️ +/-** [8] repeatedly to select the desired folder, and then select the desired file.

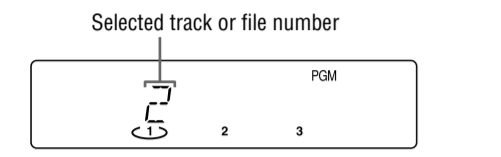

5 Press **ENTER** [20] to add the track or file to the program.

6 Repeat steps 3 through 5 to program additional tracks or files, up to a total of 15 tracks or files.

7 To play your program of tracks or files, press **▶️** [4] (or **CD/▶️** [5] on the unit).

The program remains available until you open the disc tray. To play it again, select the CD function, and press **▶️** [4] (or **CD ▶️** [5] on the unit).

To cancel Program Play, press **PLAY MODE** [17] repeatedly until “PGM” disappears while the player is stopped.

To delete the last track or file of the program, press **CLEAR** [22] on the remote while the player is stopped.

To view program information, such as total track number of the program, press **DISPLAY** [6] repeatedly.

Presetting radio stations

You can preset your favorite radio stations and tune them in instantly by selecting the corresponding preset number.

Use buttons on the remote to preset stations.

1 Press **TUNER/BAND** [5] repeatedly to select “FM” or “AM.”

2 Press **TUNING MODE** [17] repeatedly until “AUTO” appears (or “MANUAL” appears, for a station with a weak signal).

3 Press **+/-** (or **TUNING + or –** on the unit) [7] to tune in the desired station.

Scanning stops automatically when a station is tuned in, and then “TUNED” and “STEREO” (for stereo programs) appear.

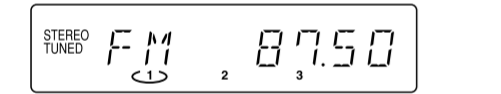

If “TUNED” does not appear and the scanning does not stop, press **TUNING MODE** [17] until “MANUAL” appears and press **+/-** (or **TUNING + or –** on the unit) [7] repeatedly to tune in the desired station.

4 Press **TUNER MEMORY** [17] on the remote.

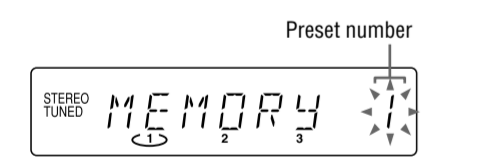

5 Press **+/-** (or **TUNING + or –** on the unit) [7] repeatedly to select your desired preset number.

If another station is already assigned to the selected preset number, the station is replaced by the new stations.

6 Press **ENTER** [20].

7 Repeat steps 1 through 6 to store other stations. You can preset up to 20 FM and 10 AM stations. The preset stations are retained for about half a day even if you disconnect the power cord or if a power failure occurs.

8 To call up a preset radio station, press **TUNING MODE** [17] repeatedly until “PRESET” appears, and then press **+/-** (or **TUNING + or –** on the unit) repeatedly [7] to select the desired preset number.

To change the AM tuning interval from the factory preset to 9 kHz or 10 kHz, tune in any AM station, and then turn off the system. Press **DISPLAY** [6] to display the clock and while hold down **TUNING +** [7] on the unit, press **I/⏻** [1] on the unit. All the AM preset stations are erased. To reset the interval to the factory preset, repeat the procedure.

Recording onto a tape

Use a TYPE I (normal) tape only.

You can record just the portions you like from a sound source, including connected audio components.

Use buttons on the unit to control tape recording.

1 Insert a recordable tape into the cassette holder with the side you want to record facing up.

2 Prepare the recording source.

Select the desired source to record.

Place the disc you want to record and press **DISC SKIP** [14] to select a disc.

When recording a folder from an MP3 disc, press **PLAY MODE** [17] repeatedly to select “[□],” and then press **⏮️ +/-** [8] repeatedly to select the desired folder.

To record only your favorite CD tracks or MP3 files in your desired order, perform steps 2 to 5 of “Creating your own CD program.”

3 Start recording.

Press **●** (record) [4], and then start playing the desired recording source.

The CD starts playing automatically.

If there is noise while recording from the tuner, reposition the appropriate antenna to reduce the noise.

While recording, you cannot listen to other sources.

To stop recording, press **■▲** [4].

Tip
We recommend that you press **■** [4] first, and then press **■▲** [4] to avoid noise being recorded when you stop recording.

Using the timers

The system offers two timer functions. If you use both timers, the Sleep Timer has priority.

Sleep Timer:

You can fall asleep to music. This function works even if the clock is not set.

Press **SLEEP** [23] on the remote repeatedly. If you select “AUTO,” the system automatically turns off after the current disc or tape stops or in 100 minutes.

If the tape deck is still playing or recording at the set time, the system turns off after the tape deck stops.

Play Timer:

You can wake up to CD or tuner at a preset time.

Use buttons on the remote to control the Play Timer. Make sure you have set the clock.

1 Prepare the sound source.

Prepare the sound source, and then press **VOLUME +/-** (or turn the **VOLUME** control on the unit) [15] to adjust the volume.

To start from a specific CD track or MP3 file, create your own CD program.

2 Press **CLOCK/TIMER SET** [19].

3 Press **⏮️/▶️** [7] repeatedly to select “PLAY,” and then press **ENTER** [20].

“ON TIME” appears, and the hour indication flashes.

4 Set the time to start playing.

Press **⏮️/▶️** [7] repeatedly to set the hour, and then press **ENTER** [20].

The minute indication flashes. Use the procedure above to set the minute.

5 Use the same procedure as in step 4 to set the time to stop playing.

6 Select the sound source.

Press **⏮️/▶️** [7] repeatedly until the desired sound source appears, and then press **ENTER** [20]. The display shows the timer settings.

7 Press **I/⏻** [1] to turn off the system.

If the system is on at the preset time, the Play Timer will not play.

To activate or check the timer again, press **CLOCK/TIMER SELECT** [19], press **⏮️/▶️** [7] repeatedly until “PLAY” appears, and then press **ENTER** [20].

To cancel a timer, repeat the same procedure as above until “OFF” appears, and then press **ENTER** [20].

To change the setting, start over from step1.

Tip
The Play Timer setting remains as long as the setting is not canceled manually.

Troubleshooting

1 Make sure the power cord and speaker cords are correctly and firmly connected.

2 Find your problem in the checklist below, and take the indicated corrective action.

If the issue persists, contact your nearest Sony dealer.

If the STANDBY indicator flashes

Immediately unplug the power cord, and check the following item.

- If your system has a voltage selector, is the voltage selector set to the correct voltage? After the STANDBY indicator [2] stops flashing, reconnect the power cord, and turn on the system. If the issue persists, contact your nearest Sony dealer.

General

There is no sound.

- Are the + and – speaker cords short-circuited?
- Are you using only the supplied speakers?
- Is anything blocking the ventilation holes on the back of the system?

Sound comes from one channel, or the left and right volumes are unbalanced.

- Place the speakers as symmetrically as possible.
- Connect only the supplied speakers.

Severe hum or noise.

- Move the system away from sources of noise.
- Connect the system to a different wall socket.
- Install a noise filter (available separately) to the power cord.

The remote does not function.

- Remove any obstacles between the remote and the remote sensor [3] on the unit, and position the unit away from fluorescent lights.
- Point the remote at the system’s sensor.
- Move the remote closer to the system.

CD/MP3 player

The sound skips, or the disc will not play.

- Wipe the disc clean, and replace it.
- Move the system to a location away from vibration (for example, on top of a stable stand).
- Move the speakers away from the system, or place them on separate stands. At high volume, speaker vibration may cause the sound to skip.

Play does not start from the first track.

- Return to Normal Play by pressing **PLAY MODE** [17] repeatedly until both “PGM” and “SHUF” disappear.

Starting playback takes more time than usual.

- The following discs take a longer time to start playback.
 - a disc recorded with a complicated tree structure.
 - a disc recorded in multisession mode.
 - a disc that has not been finalized (a disc to which data can be added).
 - a disc that has many folders.

The disc tray does not open and “LOCKED” appears.

- Contact your Sony dealer or local authorized Sony service facility.

Tuner

Severe hum or noise, or stations cannot be received. (“TUNED” or “STEREO” flashes on the display.)

- Connect the antenna properly.
- Find a location and an orientation that provide good reception, and then set up the antenna again.
- Turn off nearby electrical equipment.

Tape deck

The sound exhibits excessive wow or flutter or dropout.

- Clean the capstans and pinch rollers. Also, clean and demagnetize the tape heads. See “Precautions” for details.

To improve tuner reception

Turn off CD player power by using the CD power management function. By default, CD power is turned on. Use buttons on the unit to turn off CD player power.

1 Press **CD** on the remote (or **FUNCTION** repeatedly) [5] to select the CD function.

2 Press **I/⏻** [1] to turn off the system.

3 After “STANDBY” stops flashing, press **DISPLAY** [6] to display the clock and then press **I/⏻** [1] while holding down **■** [18] on the unit.

“CD POWER OFF” appears. With CD player power turned off, disc access time is increased. To turn on CD player power, repeat the procedure until “cD POWER ON” appears.

To reset the system to factory settings

If the system still does not operate properly, reset the system to factory settings.

Use buttons on the unit to reset the unit to its factory default settings.

1 Disconnect and reconnect the power cord, and then turn on the system.

2 Press **■** [18], **DSGX** [9], and **I/⏻** [1] at the same time.

All user-configured settings, such as preset radio stations, timer, and the clock, are deleted.

Messages

CANNOT LOCK : The system cannot be locked after you have done the procedure of “When carrying this system.”

COMPLETE : The preset operation ended normally.

FULL : You tried to program more than 15 tracks (steps).

LOCKED : The disc tray does not open. Contact your nearest Sony dealer.

NO DISC : There is no disc in the player, or you have loaded a disc that cannot be played.

NO STEP : All of the programed tracks have been erased.

NOT USED : You pressed an invalid button.

OVER : You have reached the end of the disc while pressing **▶️** [7] during playback or pause.

PUSH SELECT : You tried to set the clock or timer during timer operation.

PUSH STOP : You pressed **PLAY MODE** [17] during playback.

READING : The system is reading information from the disc. Some buttons are not available.

SET CLOCK : You tried to select the timer when the clock is not set.

SET TIMER : You tried to select the timer when the Play Timer is not set.

TIME NG : The Play Timer start and end times are set to the same time.

Display examples	
Display	indicates
[2]	2 (two)
[6]	6 (six)
[8]	8 (eight)
[A]	A
[B]	B
[D]	D
[G]	G
[H]	H
[K]	K
[M]	M
[O]	O or 0 (zero)
[Q]	Q
[R]	R
[S]	S or 5 (five)
[Z]	Z
[.]	.
[@]	@

Precautions

Discs that this system CAN play

- Audio CD
- CD-R/CD-RW (audio data/MP3 files)

Discs that this system CANNOT play

- CD-ROM
- CD-R/CD-RW other than those recorded in music CD format or MP3 format conforming to ISO9660 Level 1/Level 2, Joliet or multisession
- CD-R/CD-RW recorded in multisession that have not ended by “closing the session”
- CD-R/CD-RW of poor recording quality, CD-R/CD-RW that have scratches or are dirty, or CD-R/CD-RW recorded with an incompatible recording device
- CD-R/CD-RW which is finalized incorrectly
- Discs containing files other than MPEG 1 Audio Layer-3 (MP3) files
- Discs of non-standard shape (for example, heart, square, star)
- Discs that have adhesive tape, paper, or sticker attached to them
- Rental or used discs with attached seals where the glue extends beyond the seal
- Discs that have labels printed using ink that feels tacky when touched

Notes on discs

- Before playing, wipe the disc with a cleaning cloth from the center out to the edge.
- Do not clean discs with solvents, such as benzine thinner, or commercially available cleaners or anti-static spray intended for vinyl LPs.
- Do not expose discs to direct sunlight or heat sources such as hot air ducts, nor leave it in a car parked in direct sunlight.

On safety

- The unit is not disconnected from the AC power source (mains) as long as it is connected to the wall socket, even if the unit itself has been turned off.

- Completely disconnect the power cord (mains lead) from the wall socket (mains) if it is not going to be used for an extended period of time. When unplugging the unit, always grip the plug. Never pull the cord itself.

- Should any solid object or liquid get into the system, unplug the system, and have it checked by qualified personnel before operating it again.

- The AC power cord can be changed only by a qualified service facility.

On placement

- Do not place the system in an inclined position or in locations that are extremely hot, cold, dusty, dirty, or humid or lacking adequate ventilation, or subject to vibration, direct sunlight or a bright light.

- Be careful when placing the unit or speakers on surfaces that have been specially treated (for example, with wax, oil, polish) as staining or discoloration of the surface may result.

- If the system is brought directly from a cold to a warm location or is placed in a very damp room, moisture may condense on the lens inside the CD player, and cause the system to malfunction. In this situation, remove the disc, and leave the system turned on for about an hour until the moisture evaporates.

On heat buildup

- Heat buildup on the unit during operation is normal and is not cause for alarm.

- Do not touch the cabinet if it has been used continuously at a high volume because the cabinet may have become hot.

- Do not obstruct the ventilation holes.

On the speaker system

This speaker system is not magnetically shielded, and the picture on nearby TV sets may become magnetically distorted. In this situation, turn off the TV, wait 15 to 30 minutes, and turn it back on.

If there is no improvement, move the speakers far away from the TV.

Cleaning the cabinet

Clean this system with a soft cloth slightly moistened with a mild detergent solution. Do not use any type of abrasive pad, scouring powder, or solvent, such as thinner, benzine, or alcohol.

To prevent a tape from being accidentally recorded over

Break off the cassette’s overwrite protection tab from side A or B as illustrated.

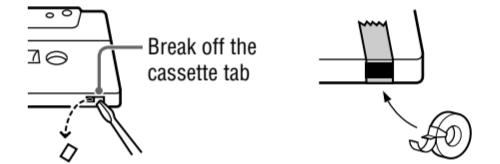

To later reuse the tape for recording, cover the broken tab with adhesive tape.

About a tape longer than 90 minutes

The use of the tape with more than 90 minutes of