

Portable MiniDisc Player

Operating instructions



*WALKMAN™ is a trademark of Sony Corporation.

MZ-E505

Printed on 100% recycled paper using VOC (Volatile Organic Compound)-free vegetable oil based ink.

eco info

Sony Corporation © 2002 Printed in Japan

WARNING

To prevent fire or shock hazard, do not expose the unit to rain or moisture.

Do not install the appliance in a confined space, such as a bookcase or built-in cabinet.

To prevent fire, do not cover the ventilation of the apparatus with newspapers, table-cloths, curtains, etc. And don't place lighted candles on the apparatus.

To prevent fire or shock hazard, do not place objects filled with liquids, such as vases, on the apparatus.

Certain countries may regulate disposal of the battery used to power this product. Please consult with your local authority.

Caution
The use of optical instruments with this product will increase eye hazard.

CAUTION — INVISIBLE LASER RADIATION WHEN OPEN

DO NOT STARE INTO BEAM OR VIEW DIRECTLY WITH OPTICAL INSTRUMENTS

Information

IN NO EVENT SHALL SELLER BE LIABLE FOR ANY DIRECT, INCIDENTAL OR CONSEQUENTIAL DAMAGES OF ANY NATURE, OR LOSSES OR EXPENSES RESULTING FROM ANY DEFECTIVE PRODUCT OR THE USE OF ANY PRODUCT.

Getting started

Charge the supplied rechargeable battery before using it for the first time.

1 Insert the rechargeable battery.

Insert the battery minus end first

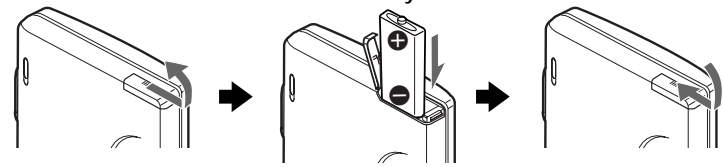

2 Charge the rechargeable battery.

How to assemble the battery charging stand

Insert the prongs until they are firmly attached.

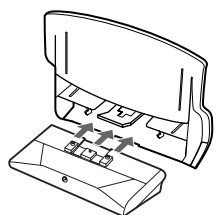
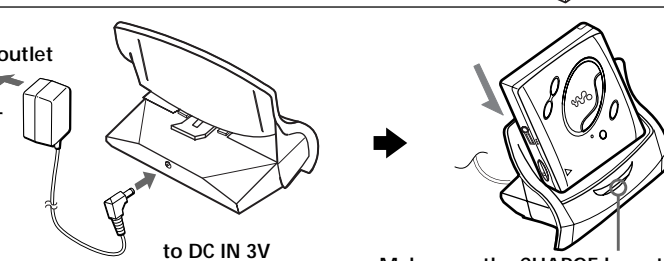
to a wall outlet
AC power adaptor

to DC IN 3V

Make sure the CHARGE lamp turns on.

- Connect the supplied AC power adaptor to DC IN 3V.
 - Place the player on the battery charging stand. Full charging takes about 6 hours and then the CHARGE lamp will go off when charging is complete.
- !** Do not operate the player when you place it on the battery charging stand or during charging. If you do so, it may cause the player to malfunction or prevent the battery from charging.

Using the dry battery

Attach the dry battery case to the player.

Insert the battery minus end first.

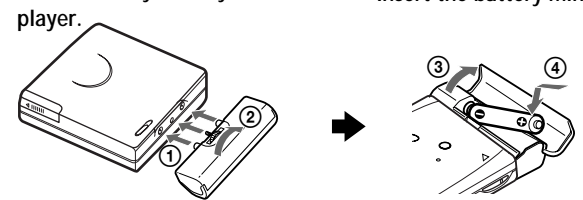

Insert a LR6 (size AA) alkaline dry battery. To operate the player for the longest possible time, use the dry battery together with a fully rechargeable battery.

3 Make connections and unlock the HOLD control.

Connect firmly.

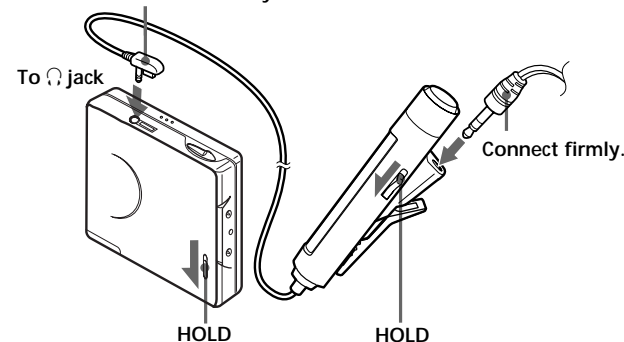

How to use the control on the remote control
Playback: Turn the control towards ►►► while the player is stopped.
FF : Turn and hold the control towards ►►► during playback.
REW: Turn and hold the control towards ◀◀◀ during playback.
AMS: Turn the control towards ►►► or ◀◀◀ during playback.

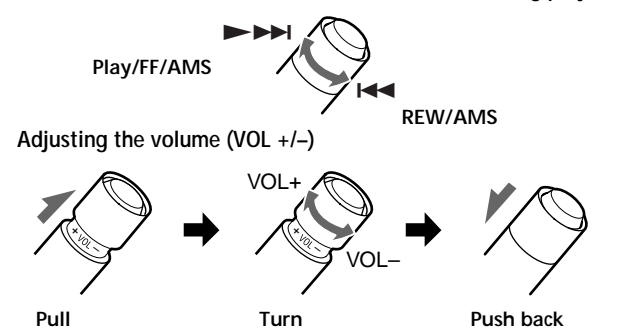

Playing an MD

1 Insert an MD.

- Slide OPEN to open the lid.
- Insert an MD.
- Close the lid.

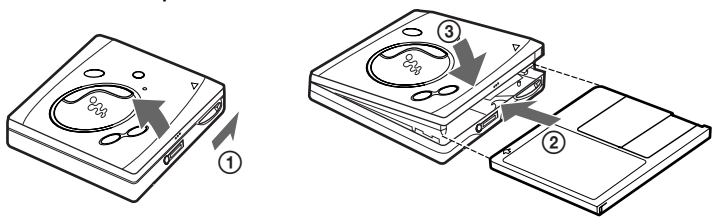

Insert an MD with the label side facing up, pushing the MD to the direction of the arrow in the illustration.

2 Play an MD.

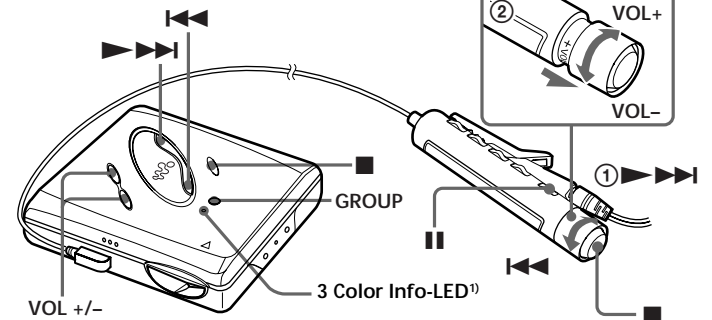

- Turn the control towards ►►► on the remote control (or press ►►► on the player) to play the disc. A short beep sounds in the headphones/earphones when using the remote control. The LED flashes and then lights up.
- Pull and turn VOL +/- on the remote control (or press VOL +/- on the player) to adjust the volume. The volume indicator appears in the display, allowing you to check the volume level. After you adjust the volume, push back the control.

To stop play, press ■. Playback starts from the point you last stopped playing. To start playback from the beginning of the disc, turn and hold the control towards ►►► on the remote control (or hold down ►►► on the player) for 2 seconds or more.
² The LED indicates the current operating status by the lighting up in the following colors:
When the battery power is exhausted, the LED starts flashing. For more details, see "When to replace or recharge the battery."

LED color	Operating status
Red	Normal play (The LED lights up continuously)
Green	Group mode* (The LED lights up continuously)
Orange	Group skip mode* (The LED lights for about 5 seconds)

*For more details, see "Using the group function."

To	Do this (Beeps ² in the headphones)
Find the beginning of the current track or the previous track ³	Turn the control towards ◀◀◀ on the remote control once (three short beeps). Press ◀◀◀ on the player once. Turn the control towards ◀◀◀ on the remote control repeatedly (continuous three short beeps). Press ◀◀◀ repeatedly on the player.
Find the beginning of the next track ⁴	Turn the control towards ►►► on the remote control (two short beeps). Press ►►► once on the player.
Go backwards while playing	Turn and hold the control towards ◀◀◀ on the remote control. Hold down ◀◀◀ on the player.
Go forward while playing	Turn and hold the control towards ►►► on the remote control. Hold down ►►► on the player.
Pause	Press ■ on the remote control (continuous short beeps). Press ■ on the remote control again to resume play.
Remove the MD	Press ■, and then slide OPEN. ⁵

² You can turn off the beep sound. For more details, see "Turning off the beep sound."

³ If you turn the control towards ◀◀◀ on the remote control (or press ◀◀◀ on the player) during the first track of the disc, the player goes to the beginning of the last track on the disc.

⁴ If you turn the control towards ►►► on the remote control (or press ►►► on the player) during the last track of the disc, the player goes to the beginning of the first track on the disc.

⁵ If you open the lid, the playback will begin from the beginning of the first track (except when group mode is on).

Note

When removing the disc, make sure to press ■ first, and then slide OPEN.

Viewing the display window of the remote control

Track number Track name⁶ or elapsed time of the track

⁶ Appears only with MDs that have been electronically labeled.

- The player can play the track recorded by 2 × or 4 × long playing mode (LP2 or LP4). Normal stereo playback, LP2 stereo playback, LP4 stereo playback or monaural playback is automatically selected to match the audio source.
- The display on the remote control will turn off shortly after you press ■.

Various ways of playback

Remote control

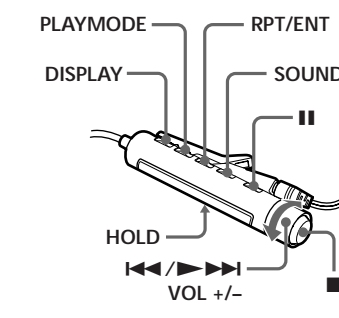

Player

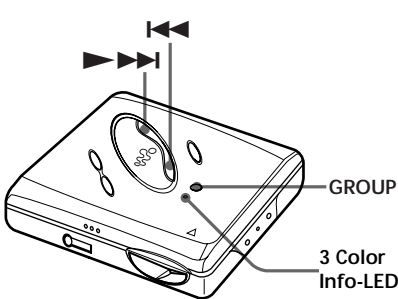

Selecting the play mode

You can select from various play modes such as shuffle play (SHUF), program play (PGM), and repeat play (◄). This procedure can be done by the remote control.

- Press PLAYMODE repeatedly to select one of the four play modes, as follows:

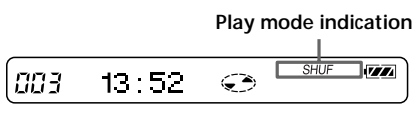

Display	Play mode
(none) (normal play)	All the tracks are played once.
"I" (single play)	A single track is played once.
"SHUF"	All the tracks are played (shuffle play) in random order.
"PGM"	Tracks are played in the order that you specified.

Listening to tracks in a desired sequence (Program Play)

- During playback, press PLAYMODE repeatedly until "PGM" flashes in the display.



- Turn the control repeatedly to select a track number.

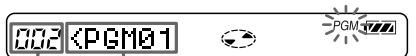

- Press RPT/ENT. The track is entered.

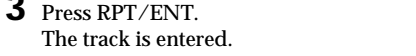

- Repeat steps 2 and 3 to select other tracks in the desired sequence.

- Hold down RPT/ENT for 2 seconds or more. The settings are entered and playback starts from the first programmed track.

Note

- The program play settings will remain in memory even after playback finishes or is stopped.
- You can set the program play up to 20 tracks.

Notes

- All program settings are lost when the lid is opened.
- If no settings are made for 5 minutes while the player is stopped, the settings made up to that point are entered.
- If you turn on group mode during program play, the program play is canceled.

Repeat play

You can use this function to repeat playback in normal play, single play, shuffle play, or program play mode.

- Press RPT/ENT on the remote control during playback. "◄" appears in the display.

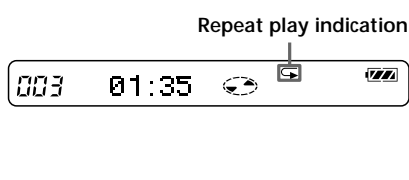

Searching for a specific track or a position quickly (Quick Search)

- You can do two kinds of quick searches.
- Index search** — Searching quickly while monitoring the track number or track name (factory setting).
 - Time search** — Searching quickly while monitoring the elapsed time.

This procedure can be done by the remote control.

- During playback, press DISPLAY for 2 seconds or more.

- Turn the control repeatedly until "SEARCH" flashes in the display, and press ■.

- Turn the control repeatedly until "Index" (index search) or "Time" (time search) flashes in the display, and press ■.

- Press ■ to pause.

- Turn and hold the control until the desired track number/track name (index search) or the desired elapsed time (time search) appears in the display.

- Press ■ to cancel the pause.

Note

- If you do this procedure while the player is in shuffle play mode, shuffle play starts from the track that you selected.
- If the player reaches to the first track or the last track on the disc as you are turning the control in step 5, it will return to the last track or the first track, respectively. (In group mode, if the player reaches to the first track or the last track in a group as you are turning the control in step 5, it will return to the last track or the first track in that group, respectively (see "Using the group function").

Track number Program number

000 <PGM01

000 <PGM01

000 <PGM02

Using the group function

The MZ-E505 can be used with a disc which has group settings. The group function is useful for playing a great number of tracks, or tracks that have been recorded in MDLP (LP2/LP4) mode.

What is a disc with group settings?

This is a disc with settings that organize tracks into groups, and which allow those groups to be selected. The MZ-E505 does not support the recording of group settings. Use your MD recorder to record group information, and then use the MZ-E505 for playback.

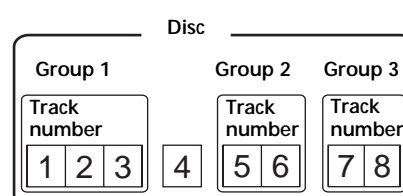

Listening to tracks in a specific group (Group Mode Playback)

Playback when group mode is off:
Playback starts with the first track in the disc, and stops with the last track in the disc.

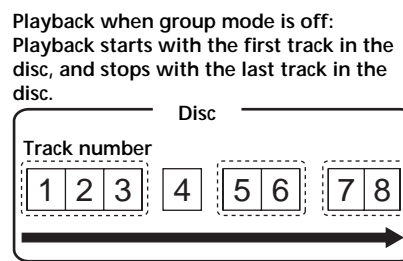

Playback when group mode is on:
Playback of the selected group starts with the first track in the group, and stops with the last track in the group.

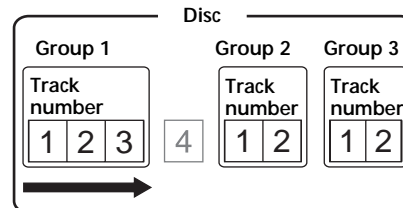

On the remote control

- Insert a disc which has group settings into the player, and then play the disc.
- Press DISPLAY for 2 seconds or more.
- Turn the control repeatedly until "GROUP" flashes, and then press ■.
- Turn the control repeatedly until "GROUP ON" flashes, and then press ■. "G" appears in the display and group mode is turned on. To turn off group mode, select "GROUP OFF" and press ■.

On the player

- Insert a disc which has group settings into the player, and then play the disc.
- Press GROUP for 2 seconds or more. The LED lights up green and group mode is turned on. To turn off group mode, press GROUP for 2 seconds or more again. The LED lights up red.

! When group mode is on, it is possible to do repeat play, shuffle play, or program play. For details on the respective operations, see "Selecting the play mode."

- In group mode, turning the controls on the remote control towards ►►► during playback of the last track of a group moves playback to the first track of the group. Turning the control 2 times on the remote control towards ◀◀◀ while playing the first track of a group moves playback to the last track of the group.

Note

In group mode, the player treats all tracks without group settings as belonging to the last group on the disc. The last group is indicated in the display on the player as "Gpou --." Within a group, the tracks appear in their order on the disc, not their order within the group.

Selecting and playing specific groups (Group Skip Function)

When playing a disc with group settings, the group skip function allows you to jump from the currently playing group to any other group on the MD. The group skip function can be used even though the player is not in group mode.

When group mode is off:

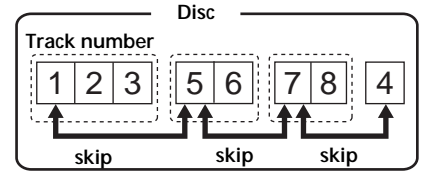

When group mode is on:

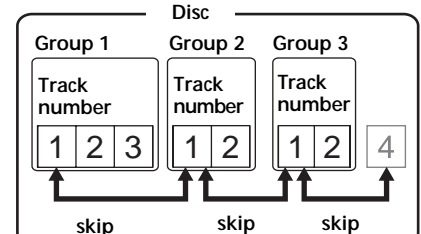

On the remote control

- Insert a disc which has group settings into the player and play the disc.
- Hold down PLAYMODE until "----" in the display. The player enters group skip mode.
- Within 5 seconds, turn the control repeatedly until the name or number of the desired group appears.

When there is a group name (Example: AAA)

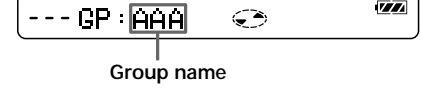

When there is no group name



On the player

- Insert a disc which has group settings into the player and play the disc.
- Press GROUP. The LED lights up orange and the player enters group skip mode.
- Within 5 seconds, press ◀◀◀ or ►►► repeatedly until the name or number of the desired group appears.

Note

If no operation is performed within 5 seconds in step 3, group skip mode is cancelled. To do the procedure, start from step 2 again.

Registering groups using your minidisc recorder

If your MD recorder (MD deck or recording MD Walkman) has a function for editing disc names, you can use it to register groups even if your recorder does not have the group function. Make sure you enter the text string exactly as described below. The group function will not work if you enter the text string incorrectly.

To specify groups

- Change the disc name to the following by using your MD recorder:

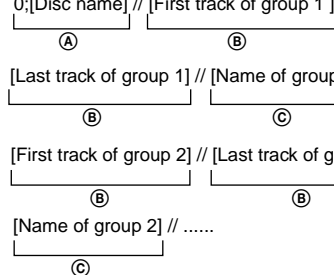

- A Disc name
- B Track number
- C Group name
- / Separator between group names
- Separator between track number and Group name

(Ex.) Set the following groups for the disc named "Collections":
0:Collections//
1-7: My Favorites"2001winter"
Group name for tracks 1-7:
8-17:Jun&Tac"sunshine head"
Group name for tracks 8-17:
Jun&Tac"sunshine head"
Group name for tracks 18-24:
THE NIGHT BUTTERFLYS
Group name for tracks 25-32:
Dream World/Kiss Me!

Text string entered:

0:Collections//
1-7: My Favorites"2001winter"
8-17:Jun&Tac"sunshine head"
18-24:THE NIGHT BUTTERFLYS//
25-32:Dream World/Kiss Me!//

- Up to 99* groups can be registered on a single MD.
- The characters "-", "/", and "." can be used in a group name.
- You can register the same group name more than twice on the same MD.
- You can specify a group without entering a group name (C) for it.

* The actual number depends on the editing ability of your recorder and may be less than 99 in some cases.

Note

Depending on the specifications of your MD recorder, the group function will not work.

Adjusting the sound quality (Digital Sound Preset)

You can emphasize the treble and bass to suit your taste. The player can store two sets of treble-bass adjustments, which can be selected later during playback. This procedure can be done by the remote control.

To select the sound quality

Factory settings
The factory settings of each digital sound preset are as follows:
• "SOUND1": bass +1, treble ±0
• "SOUND2": bass +3, treble ±0

- During playback, press SOUND repeatedly to select "SOUND1" or "SOUND2."



To adjust the sound quality

- During playback, press SOUND repeatedly to select "SOUND1" or "SOUND2."



- Press SOUND for 2 seconds or more. The player changes to the bass-setting mode. Pressing SOUND for 2 seconds or more again changes the player to the treble-setting mode.

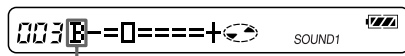

When you select bass-setting mode, "B" appears. When you select treble-setting mode, "T" appears.

- Turn the control repeatedly to adjust the bass or the treble.

Example: While adjusting the bass, the cursor moves. (Position: -2)

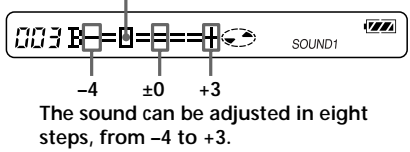

The sound can be adjusted in eight steps, from -4 to +3.

- Press RPT/ENT. The sound settings are stored and the playback display appears again.

To select a preset sound

Press SOUND repeatedly to select "SOUND1," "SOUND2," and then do steps 2 and 3.

Selecting no display turns off the digital sound preset function.

Note
When using a digital sound preset, the sound may break or become distorted if the volume is turned up too high, depending on the settings or the track.

Other operations

Viewing the track name and playing time

You can check the track or disc name, track number, the elapsed playing time of the current track, the number of the tracks recorded on the MD, the group name, and the total number of tracks in a group.



- Press DISPLAY on the remote control. Each time you press DISPLAY, the display changes as follows:

A	B
Track number	The elapsed time
Track number	Track name
The number of total tracks	Group name
The number of total tracks	Disc name
Track number	Track mode

The group name appears when you select the group on group skip mode. For more details, see "Selecting and playing specific groups" in "Using the group function."

Notes

- Depending on whether group mode is on or off, the operating conditions, or the settings may not be selectable or the indications that appear may vary.
- The track mode indication appears only during playback. It appears for 2 seconds, and is then replaced by the elapsed time of the current track.

▶ Other operations (continued)

Remote control

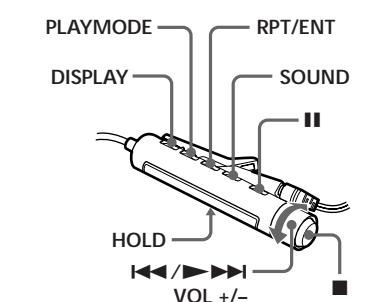

Player

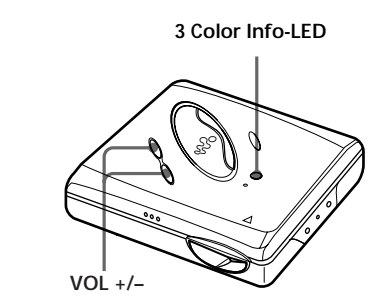

Bottom side of the player

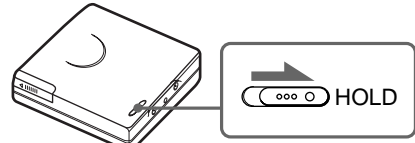

Turning off the beep sound

You can turn off the beep sound of the remote control in the headphones/earphones. This procedure can be done by the remote control.

- Press DISPLAY for 2 seconds or more.
- Turn the control repeatedly until "OPTION" flashes in the display and press ■.
- Turn the control repeatedly until "BEEP" flashes in the display and press ■.
- Turn the control repeatedly until "BEEP OFF" flashes in the display and press ■.

To cancel the setting
Select "BEEP ON" and press ■ in step 4.

To cancel the setting
Select "BEEP ON" and press ■ in step 4.

Locking the controls (HOLD)

- Slide HOLD on the remote control in the direction of the ➡ to lock the controls of the remote control and slide HOLD on the player in the direction of the ➡ to lock the controls of the player.

To unlock the controls
Slide HOLD to the opposite directions of the arrows.

Preserving battery power (Power Save Mode)

You can reduce power consumption and extend the operating life of the battery by turning off the LED during all times regardless of the operating condition. This procedure can be done by the remote control.

- Press DISPLAY for 2 seconds or more.
- Turn the control repeatedly until "OPTION" flashes in the display, and then press ■.
- Turn the control repeatedly until "PowerSave" flashes in the display, and then press ■.
- Turn the control repeatedly until "P-SaveON" flashes in the display, and then press ■.

To cancel the setting
Select "P-SaveOFF" and press ■ in step 4.

- During playback, press DISPLAY for 2 seconds or more.

- Turn the control repeatedly until "OPTION" flashes in the display and press ■.

- Turn the control repeatedly until "AVLS" flashes in the display and press ■.

- Turn the control repeatedly until "AVLS ON" flashes in the display and press ■. "AVLS ON" appears in the display.

On the player

- During playback, slide HOLD towards ➡.
- While pressing VOL -, slide HOLD in the opposite direction.





To cancel the AVLS function
On the remote control, select "AVLS OFF" in step 4.



On the player, during playback, slide HOLD in the direction of ➡, and then while pressing VOL +, slide HOLD in the opposite direction.

▶ Power sources

When to replace or recharge the battery

You can check the battery condition through the battery indicator on the remote control and the LED on the player while using the player.

	Battery power decreasing
	Weak battery
	The battery has gone out.
	"LOW BATT" flashes in the display on the remote control, and the power goes off.

Indicator of the LED on the player	
The LED lights up.	There is sufficient battery power.
	
The LED flashes slowly.	Battery power decreasing
	
The LED flashes quickly.	The battery is low. The LED will soon turn off and the supply of power will stop.

Notes

- The battery indicator may show the battery to be fully charged even when it is not. Charging the battery shorter than the prescribed time will result in a shorter operating time on the player.
- The battery indicator will show a low charge during forward or backward operation or when the operating temperature is extremely low.

<i>Battery life</i> ^① <i>(Unit: Approx. hours) (JEITA)</i> ^②			
Batteries	SP Stereo (normal)	LP2 Stereo	LP4 Stereo
Ni-MH rechargeable battery NH-14WM(A) ^③	33	37	43

LR6 (SG)	49	54	64
Sony Alkaline dry battery ^④			
LR6 (SG) ^⑤ and NH-14WM(A) ^⑥	87	97	120

^① Measured with the power save function on (see "Preserving battery power") is on.

^② Measured in accordance with the JEITA (Japan Electronics and Information Technology Industries Association) standard (using a Sony MDW-series Mini-disc).

^③ With a fully charged battery ^④ When using a Sony LR6 (SG) "STAMINA" alkaline dry battery (produced in Japan).

Note

The battery operation may be shorter than that specified, depending on the operating conditions, the temperature of the location, and the type of battery being used.

▶ Additional information

Precautions

On safety
• Make sure to keep the player in the supplied carrying pouch. If the terminals on the player, battery charging stand, or battery case are accidentally brought into contact with a metallic object, they may short-circuit and begin to heat up.

- Keep the terminals on the player or on the battery case away from metallic objects or surfaces. Such contact may short-circuit the terminals and cause dangerous heat generation. When carrying the player with you, always keep the battery case attached to the player and the player in the supplied carrying pouch.

- When you carry the supplied rechargeable battery, be sure to put it in the supplied rechargeable battery carrying case. Carrying the rechargeable battery without the case may cause a short-circuit with metallic objects such as coins, key rings, or necklaces. As a result, heat may be generated.
- Do not put any foreign objects in the DC IN 3V jack.
- Do not carry or store the dry battery or battery case in the same place with metallic objects such as coins, key rings, or necklaces. This may cause a short-circuit and the generation of heat.

- Incorrect battery usage may cause the battery fluid to leak or battery to burst. To prevent such accidents, observe the following precautions:
 - Install battery with the + and - poles aligned correctly.
 - Do not charge dry battery.

- If a battery leak should develop, carefully and thoroughly wipe away the battery fluid in the battery compartment before inserting a new battery.
- If you will not use the player for a long time, be sure to disconnect the power supply (AC power adaptor, dry battery, rechargeable battery, or battery charging stand). When disconnecting the AC power adaptor from the electrical outlet, grasp the adaptor plug itself; never pull the cord.

On the AC power adaptor (for the supplied battery charging stand)
• For use in your house: Use the supplied AC power adaptor. Do not use any other AC power adaptor since it may cause the player to malfunction.

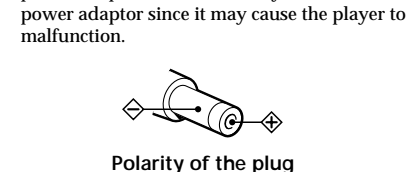
	Polarity of the plug
--	-----------------------------

- Position the player within easy reach of the electrical outlet. Should you notice an abnormality in the player, disconnect the AC power adaptor from the electrical outlet immediately.

On charging

- The supplied battery charging stand can be used only with the MZ-E505. It cannot be used to charge any other models.
- Do not use the MZ-E505 to charge any other battery besides the one designated for it.
- The battery charging stand and the battery may become hot during the charging procedure; this, however poses no danger.
- Because of the battery's characteristics, the capacity of the battery may be smaller than normal when it is used for the first time or after a long period of disuse. In this case, charge and discharge the battery several times. The normal battery life will be restored.
- The rechargeable battery can be recharged about 300 times.
- If the capacity of the rechargeable battery drops to half the normal amount, replace it with a new one.
- Remove the rechargeable battery when the unit will not be used for a long time.
- If you are not going to use the player for a long time, remove the AC power adaptor from the wall outlet, and remove the player from the battery charging stand.
- The CHARGE lamp will go off about 6 hours after you place the player on the battery charging stand for 3 seconds or more while it is charging, the CHARGE lamp will go off and it will take about 6 hours for the lamp to go off from the next time you place the player on the battery charging stand.

On Handling

- Do not drop or bump the player. This may cause the player to malfunction.
- Do not pull on the remote control or headphones/earphones cords.
- Do not place the player in the following places:
 - An extremely hot place (over 60°C (140°F)
 - A place exposed to direct sunlight or near a heater
 - In a car with the windows rolled up (especially in the summer)
 - In a damp place such as a bathroom
 - Near a source of electromagnetic fields such as a magnet, speaker, or TV
 - In a dusty place

On heat build-up
Heat may build up in the player if it is used for an extended period of time. This, however, is not a malfunction.

On mechanical noise

The player emits mechanical noise while operating, which is caused by the power-saving system of the player. This is not a malfunction.

On installation

- Never use the player where it will be subjected to extremes of light, temperature, moisture or vibration.
- Never wrap the player in anything when it is being used with the AC power adaptor. Heat build-up in the player may cause malfunction or injury.

On the remote control
The supplied remote control is designed for use with the MZ-E505 only. Note also that the player cannot be controlled by remote controls for other models.

On the MiniDisc cartridge

- Do not touch the internal disc directly. Forcing the shutter open may damage the internal disc.
- When transporting a minidisc, keep it in its case.
- Do not place the cartridge where it will be subjected to light, temperature, moisture or dust.
- Do not affix the label outside of the specified area on the MD. Make sure the label is placed within the recessed space on the disc.

On the headphones/earphones

Road safety

- Do not use headphones/earphones while driving, cycling, or operating any motorized vehicle. This may lead to a traffic accident and is illegal in many areas. It can also be potentially dangerous to play your player at high volumes while walking, especially at pedestrian crossings. You should exercise extreme caution or discontinue using the player in potentially hazardous situations.
- If you experience an allergic reaction to the supplied headphones/earphones, stop using them at once and consult a doctor or a Sony service center.

Preventing hearing damage

Avoid using headphones/earphones at high volumes. Hearing experts advise against continuous, loud and extended play. If you experience a ringing in your ears, reduce the volume or discontinue use.

Caring for others

Keep the volume at a moderate level. This will allow you to hear outside sounds and to be considerate of the people around you.

On the battery case

The supplied battery case is designed for use with the MZ-E505 only.

On cleaning

- After wiping the player casing with a soft cloth slightly moistened with water, wipe it again with a dry cloth. Do not use any type of abrasive pad, scouring powder or solvent such as alcohol or benzene as this may mar the finish on the casing.
- Wipe the disc cartridge with a dry cloth to remove dirt.
- Dust on the lens may prevent the unit from operating properly. Be sure to close the disc compartment lid after inserting or ejecting an MD.

- Use soft liquid soap, use a soft cloth to clean the plugs of the headphones/earphones and remote control. A dirty plug may cause noise or intermittent breaks in the sound during playback.
- Clean the terminals periodically with a cotton swab or a soft cloth as illustrated.

Rechargeable battery compartment

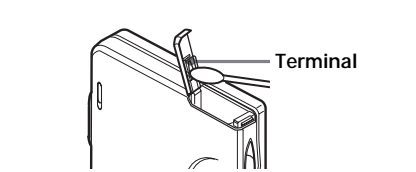

Dry battery case

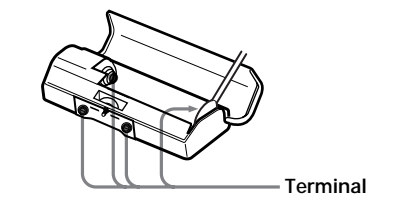

Rechargeable battery (supplied)/ Dry battery (not supplied)

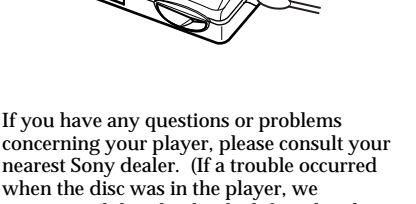
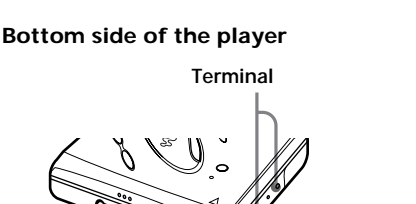
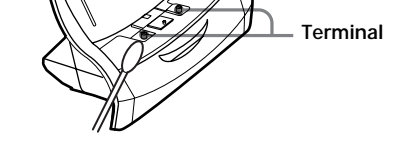
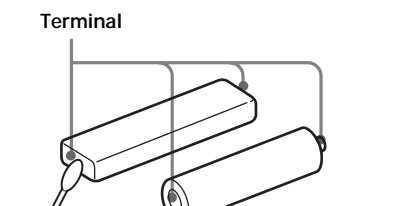

If you have any questions or problems concerning your player, please consult your nearest Sony dealer. (If a trouble occurred when you consult your Sony dealer so that the cause of trouble may be better understood.)

Troubleshooting

The player does not work or works poorly.

- You tried to play with no disc in the player ("NO DISC" flashes on the remote control).
 - Insert an MD.
- The hold function is activated and the controls are locked. (If you press any of the operation buttons on the player, "HOLD" flashes on the remote control.)
 - Slide HOLD in the opposite direction of the arrow to release the hold function.

- When the remote control is enabled for settings ("MENU" appears on the remote control when a button on the player is pressed.)
 - End the setting procedure using the remote control or disconnect the remote control plug.

- Moisture has condensed inside the player.
 - Take the MD out and wait for several hours until the moisture has evaporated.

- The rechargeable battery or dry battery is weak ("LOW BATT" flashes on the remote control).
 - Insert a new dry battery or recharge the battery.

- The rechargeable battery or dry battery has been installed incorrectly.
 - Install the battery with correct polarity.

- An MD with nothing recording on it is inserted ("BLANKDISC" flashes on the remote control).
 - Insert a recorded MD.

- The player cannot read the disc. (it's scratched or dirty) ("DISC ERR" flashes on the remote control).
 - Reinsert or replace the disc.

- While operating, the player received a mechanical shock, too much static, abnormal power voltage caused by lightning etc.
 - Restart the player as follows:
 - Disconnect the power source.
 - Let the player sit for about 30 seconds.
 - Reconnect the power source.

The MD does not play normally.

- The player is set to the repeat mode. ("↺" is displayed on the remote control.)
 - Press RPT/ENT on the remote control repeatedly until "↺" disappears, then start playing.
- The disc is playing in group mode.
 - Turn off group mode.

The MD does not play from the first track.

- The disc stopped playing before reaching the last track.
 - Turn and hold the control towards ▶▶▶▶ for 2 seconds or more to start playing from the first track.

- The disc is playing in group mode.
 - Turn off group mode and stop playback, then turn and hold the control towards ▶▶▶▶ for 2 seconds or more to start playing from the first track.

The digital sound preset function does not work.

- The digital sound preset function is off.
 - Press SOUND on the remote control repeatedly to select "SOUND1" or "SOUND2."

The playback sound skips.

- The player is placed where it receives continuous vibration.
 - Place the player at a stable place.
- A very short track may cause sound to skip.

The sound has a lot of static.
• Strong magnetism from a television or other device causing interference.

- Move the player away from the source of strong magnetism.

- Noise is momentarily heard.
 - The sound was recorded in LP4 stereo mode.
 - Because of the nature of the compression method used in LP4 mode, noise may be output on very rare occasions during playback of sound recorded in this mode.

The rechargeable battery does not start charging.

- The terminals of the battery charging stand are dirty.
 - Wipe the terminals with a dry cloth.
- The rechargeable battery is not inserted in the player. (When the player is on the battery charging stand, "NO BATT" appears on the remote control when you press one of the operation buttons on the player or the remote control in order to check the battery level.)
 - Insert the rechargeable battery into the player.

The CHARGE lamp does not turn on.
• The rechargeable battery is not inserted in the player.

- Insert the rechargeable battery into the player.

The player does not operate properly.
• The player is operating while still placed on the battery charging stand.

- Remove the player from the battery charging stand.

- An attempt was made to enter group mode with program play selected.
 - Change to group mode before selecting program play.

There is no sound output from the headphones/earphones or the sound is too low.

- The headphones/earphones plug is not firmly inserted.
 - Insert the headphones/earphones plug firmly to the remote control.
- Insert the headphones/earphones plug firmly into the ♪ jack.

- AVLS is on.
 - Cancel the AVLS function. For more details, see "To cancel the AVLS function" in "Protecting your hearing."

The 3 Color Info-LED does not turn on.
• Power save mode is on.

- Turn off power save mode. For more details, see "Preserving battery power."

The group function (group mode/group skip mode) does not function.
• An attempt was made to enter group mode while using a disc that has no group settings.

- Use a disc with group settings.

- An attempt was made to enter group mode while playing a track that belongs to no group.
 - The group function cannot be used while a track that belongs to no group is playing.

- An attempt was made to enter group mode with program play selected.
 - Change to group mode before selecting program play.

When you rewind/forward, the track does not go back or go forward to the consecutive track.

- Group skip mode is on
 - Turn off group skip mode. Group skip mode will be canceled if no operation is performed within 5 seconds. For more details, see "Selecting and playing specific groups."

Specifications

Audio playing system
MiniDisc digital audio system
Laser diode properties
Material: GaAlAs
Wavelength: λ = 790 nm
Emission duration: continuous
Laser output: less than 44.6 μW
* This output is the value measured at a distance of 200 mm from the objective lens surface on the optical pick-up block with 7 mm aperture.
Revolutions
Approx. 300 rpm to 2,700 rpm
Error correction
ACIRC (Advanced Cross Interleave Reed Solomon Code)
Sampling frequency
44.1 kHz
Coding
ATRAC (Adaptive TRansform Acoustic Coding)
ATRAC3: LP2/LP4
Modulation system
EFM (Eight to Fourteen Modulation)
Number of channels
2 stereo channels
1 monaural channel
Frequency response
20 to 20,000 Hz ± 3 dB
Wow and Flutter
Below measurable limits
Outputs
Headphones/earphones: stereo mini-jack, maximum output level 5 mW + 5 mW load impedance 16 Ω
Power requirements
Player:
Nickel metal hydride rechargeable battery
One NH-14WM(A) (supplied): 1.2V, 1,350 mAh
One LR6 (size AA) battery (not supplied)
Battery charging stand:
AC power adaptor DC 3V, AC 100V, 50/60Hz
Battery operation time
See "When to replace or recharge the battery"
Dimensions
Approx. 74.5 × 81.0 × 17.6 mm (w/h/d) (3 × 3 1/4 × 3 7/16 in.) (not including projecting parts and controls)
Mass
Approx. 73 g (2.6 oz) (the player only)
Supplied accessories
Headphones/earphones with a remote control (1)
Battery charging stand (1)
AC power adaptor (for the supplied battery charging stand) (1)
Rechargeable battery (1)
Rechargeable battery carrying case (1)
Dry battery case (1)
Carrying pouch (1)

US and foreign patents licensed from Dolby Laboratories.

Design and specifications are subject to change without notice.

Optional accessories

- NH-14WM Nickel metal hydride rechargeable battery
- MDR series stereo headphones/earphones* SRS series Active Speakers

- Whether you should plug the headphones/earphones directly to the ♪ jack on the main unit, use only headphones/earphones with stereo mini plugs. Headphones/earphones with a microplug cannot be used.

Your dealer may not handle some of the above listed accessories. Please ask the dealer for detailed information about the accessories in your country.

Parts and controls

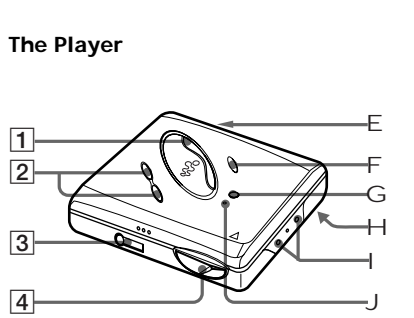

- ⏪/▶▶▶ button
- VOL +/- button
- ♫ (earphones) jack
- OPEN switch
- Battery compartment
- GROUP button
- button
- HOLD (Locking the control) switch
- Terminals for charging stand/ dry battery case (at the bottom)
- 3 Color Info-LED

* The ▶▶▶ and VOL + buttons have tactile dots.

The earphones with a remote control

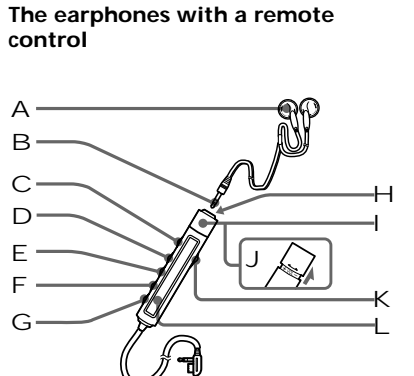

- Headphones/earphones
- Stereo mini plug
- (pause) button
- SOUND button
- RPT/ENT (Repeat/Enter) button
- PLAYMODE button
- DISPLAY button
- (stop) button**
- Control (⏪/▶▶▶)
- Control VOL +/-
- HOLD (Locking the control) switch
- Display window

** The stop button also operates as the enter button, depending on the function.

The display window of the remote control

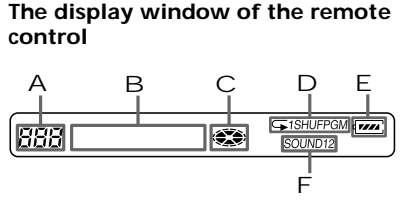

- Track number display
- Character information display
- Disc indication
- Play mode indication
- Battery level Indication
- SOUND indication

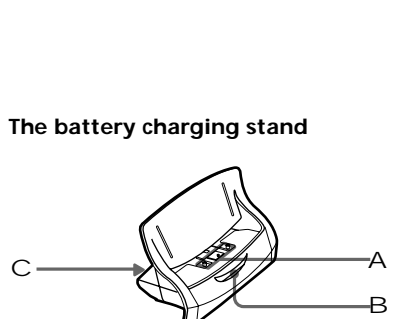

- Terminals for charging
- CHARGE lamp
- DC IN 3V jack (at the rear)