

Portable CD Player

Operating Instructions 使用说明书



D-EJ761

Sony Corporation ©2002

http://www.sony.net/

“WALKMAN” is a registered trademark of Sony Corporation to represent Headphone Stereo products. **WALKMAN** is a trademark of Sony Corporation.



Printed on 100 % recycled paper using VOC (Volatile Organic Compound)-free vegetable oil based ink.

CD player (front)/CD 播放机 (正面)

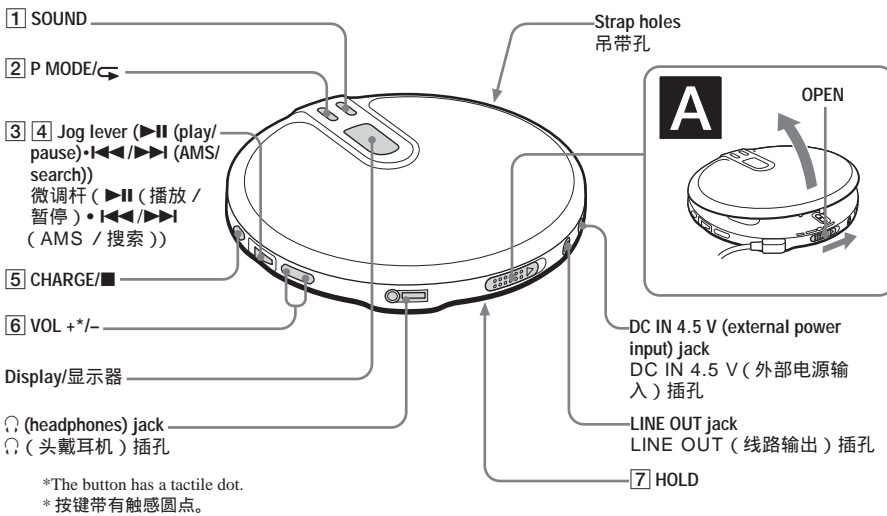

CD player (inside)/CD 播放机 (里面)

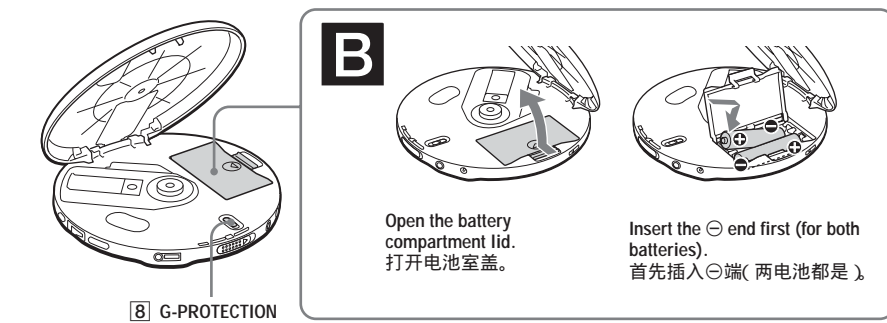

Display/显示器

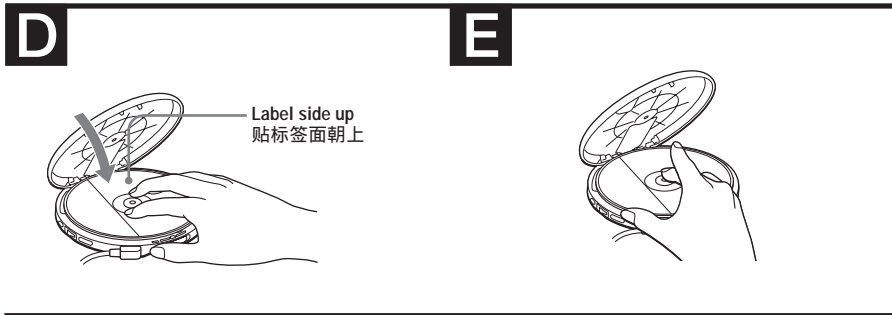
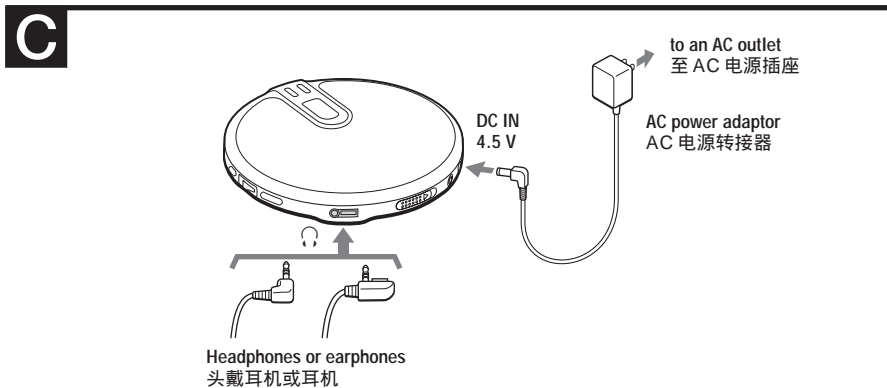
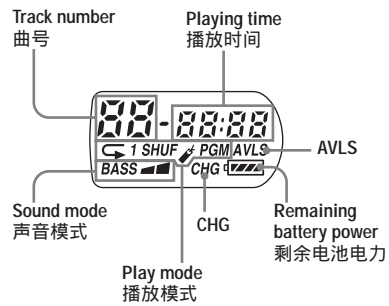

WARNING

To prevent fire or shock hazard, do not expose the unit to rain or moisture.

Do not install the appliance in a confined space, such as a bookcase or built-in cabinet.

To prevent fire, do not cover the ventilation of the apparatus with newspapers, tablecloths, curtains, etc. And don't place lighted candles on the apparatus.

To prevent fire or shock hazard, do not place objects filled with liquids, such as vases, on the apparatus.

Certain countries may regulate disposal of the battery used to power this product. Please consult with your local authority.

CAUTION

- INVISIBLE LASER RADIATION WHEN OPEN
- DO NOT STARE INTO BEAM OR VIEW DIRECTLY WITH OPTICAL INSTRUMENT

The validity of the CE marking is restricted to only those countries where it is legally enforced, mainly in the countries EEA (European Economic Area).

Power Sources

To use the AC power adaptor (C)

- 1 Connect the AC power adaptor to an AC outlet.

To use the batteries (B)

Use only the following batteries for your CD player:

Rechargeable batteries

Charge the rechargeable batteries before using them for the first time.

- NH-WM2AA (NH-WMAA × 2)

Dry batteries

- LR6 (size AA) alkaline batteries

To insert the batteries

- 1 Open the battery compartment lid inside your CD player.
- 2 Insert two batteries by matching the ⊕ to the diagram in the battery compartment and close the lid until it clicks into place.
- 3 When using the rechargeable batteries, connect the AC power adaptor to the DC IN 4.5 V jack of your CD player and an AC outlet, then press CHARGE/■ to start charging. The CD player charges the batteries. The “CHG” indicator turns on in the display and the indicator sections of ■■■■ light up in succession. When the batteries are completely charged, the “CHG” and ■■■■ indicators get turned off. If you press CHARGE/■ after the charge has already been completed, the ■■■■ indicator flashes and “Full” appears in the display.
- 4 Disconnect the AC power adaptor.

Battery life* (approx. hours)

(When the CD player is used on a flat and stable place.)
Playing time varies depending on how the CD player is used.

	G-PROTECTION	
	on	off
NH-WM2AA (charged for about 4 hours**)	32	24
Two Sony alkaline batteries LR6 (SG) (produced in Japan)	50	35

* Measured value by the standard of JEITA (Japan Electronics and Information Technology Industries Association).

** Charging time varies depending on how the rechargeable battery is used.

To check the remaining power of the batteries

You can check it in the display.
Replace the batteries when “■■■■” flashes.

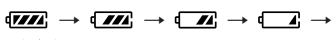

■■■■ → Lo batt*

* Beep sounds.

Button/Switch	Function/Operation
7 HOLD	Use to lock the controls to prevent accidental button presses.
8 G-PROTECTION	Protect against sound skipping.*1

*1 AMS = Automatic Music Sensor

*2 If the sound is distorted when using the SOUND function, turn down the volume.

*3 AVLS = Automatic Volume Limiter System

*4 Sound may skip:

- if the CD player receives stronger continuous shock than expected,
- if a dirty or scratched CD is played or
- when using poor-quality CD-Rs/CD-RWs or if there is a problem with the recording device or application software.

To remove the CD

Remove the CD while pressing the pivot (E).

(Continue to the reverse side)



警告

为防火灾或触电危险，切勿让机器暴露于雨中或潮湿处。

别把机器安装在诸如书橱或壁橱等密闭处。

为防火灾，请勿让装置的通风孔盖住报纸，桌布，窗帘等。也不可在装置上点放蜡烛。

为防火灾或触电危险，不可在装置上摆饰花瓶等装满液体的物体。

一部分国家对于本产品的电源用电池可能规定有处置的标准。请咨询当地有关当局。

注意

- 开着时，将有看不见的激光辐射
- 别凝视激光束或直接用光学仪器观看

CE 标志的有效性，仅限于那些有法律限制的国家，主要在 EEA (欧洲经济区) 国家。

连接电源

使用 AC 电源转接器 (C)

- 1 将 AC 电源转接器连接到 AC 电源插座。

使用电池 (B)

本 CD 播放机限使用下列电池：

充电式电池

初次使用充电式电池时，必须进行充电。

- NH-WM2AA (NH-WMAA × 2)

干电池

- LR6 (AA, 5 号) 碱性电池

插入电池

- 1 打开 CD 播放机里面的电池室盖。
- 2 装入 2 个电池使 ⊕ 对准电池室中的图示，然后关上盖子至卡搭定位。
- 3 将 AC 电源转接器连接到您的 CD 播放机上的 DC IN 4.5 V 插孔和 AC 电源插座，然后按 CHARGE/■ 以开始充电。CD 播放机开始为电池充电。“CHG”指示灯在显示器上点亮。■■■■ 指示灯的灯节将陆续点亮。当电池充电完成时，“CHG”和 ■■■■ 指示灯熄灭。如果在充电完成后按 CHARGE/■ ■■■■ 指示灯闪烁，显示器上出现 “Full”。
- 4 断开 AC 电源转接器。

电池使用时间* (大约时数)

(在平稳表面使用 CD 播放机时)
播放时间因 CD 播放机的使用状况而异。

	G-PROTECTION 设定	
	开	关
NH-WM2AA (充电大约 4 小时**)	32	24
两 Sony 碱性电池 LR6 (SG) (日本制)	50	35

* JEITA (Japan Electronics and Information Technology Industries Association) (日本电子和信息产业协会) 的标准测值。

** 充电时间，随充电式电池的使用状况而异。

检查电池剩余电力

可以在显示器上检查。
当 “■■■■” 闪烁时请更换电池。

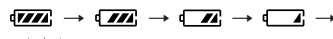

■■■■ → Lo batt*

* 哔声。

注

- ■■■■ 的指示灯节粗示剩余电池电力。其一个灯节不一定正确代表电池电力的四分之一。
- 根据操作条件 ■■■■ 的指示灯节的使用时间可能增加或减少。

何时更换充电式电池

当电池使用时间缩短到大约一半时，即请更换新的充电式电池。

充电式电池须知

- 为保持充电式电池原有容量维持长时间的电池使用时间，请在完全耗尽电力时才给电池充电。
- 新充电式电池或搁置长时间没用的充电式电池，可能不能完全充满电。须等充电使用过数次之后才能达到完全充满电。
- 请利用附带的电池携带盒以防意外生热。让充电式电池和金属小件物品混合放置，可能因发生短路而生热，甚至有起火危险。

使用干电池的注意事项

- 务必卸下 AC 电源转接器。
- 当电池用完时，同时更换两节新电池。

播放 CD

插入 CD

- 1 滑动 OPEN 打开顶盖 (A)。
- 2 把 CD 接入中心轴，然后盖上顶盖 (D)。

注

- 本 CD 播放机可以播放以激光光盘数码音频 (音频 CD) 格式录制的 CD-R/CD-RW。但播放能力取决于光盘质量和录音设备的状况。
- 本产品设计用于播放符合 Compact Disc (CD) 标准的光盘。近来，许多录制公司都出售各种用版权保护技术编码的音乐光盘。请注意，这些光盘中可能会有不符合 CD 标准的光盘，且可能无法用本产品播放。

操作 CD 播放机

按钮 / 开关	功能 / 操作
1 SOUND	• 用来加强低音。反复按此钮以选择 BASS ■■ 或 BASS ■■■■。BASS ■■■■ 的作用强于 BASS ■■。*2 • 也用来限制最大音量以保护听力。按住此钮直到 “AVLS*3” 出现在显示器上。AVLS 功能开启。要关闭 AVLS 功能，再次按住此钮直到 “AVLS” 消失。
2 P MODE/◀ (播放模式 / 重现)	反复按直到所要的播放模式出现在显示器上。 无显示：正常播放 “1”：单首曲目播放 “SHUF”：随机播放 “📌”：播放加记书签曲子 “PGM”：PGM (程序) 播放 要重现选定的播放模式，按住此钮直到 “◀” 出现。
3 ▶ (播放 / 暂停)	按下此杆开始播放。再按一次暂停播放。 要从第一个曲子开始播放，当 CD 播放机停止时，按住此钮 2 秒以上。
4 ◀◀/▶▶ (AMS*1 / 搜索)	朝 ◀◀ 或 ▶▶ 按此钮一次查找当前 / 下一曲子的开头。反复朝 ◀◀ 或 ▶▶ 按此钮查找前面 / 后面曲子的开头。朝 ◀◀ 或 ▶▶ 方向按住此钮快退 / 快进。
5 CHARGE/■ (停止)	按下停止播放。
6 VOL +/-	按下以调节音量。
7 HOLD	用于锁定控制钮以防止意外拨动。
7 G-PROTECTION	防止声音跳动。*4

*1 AMS=自动音乐传感器

*2 当使用 SOUND 功能时，如果声音失真，请降低音量。

*3 AVLS=自动音量控制系统

*4 声音可能跳动：

- 如果 CD 播放机受到比预计更强的连续震动，
- 如果播放脏的或划伤的 CD 或
- 当使用低劣的 CD-R/CD-RW 时或录制设备或应用软件有问题。

要取出 CD

按住中心轴 (E)，取下 CD。

(续背面)

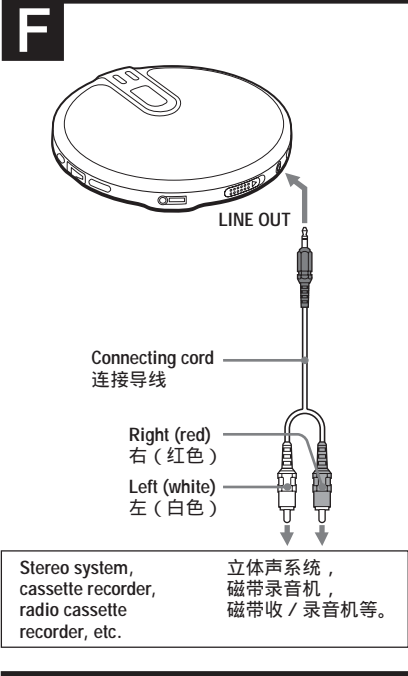

English

To turn off the operation beep sound

You can turn off the beep sound that is heard from your headphones/earphones when you operate your CD player.

- Remove the power source (AC power adaptor, rechargeable batteries or dry batteries) from the CD player.
- Connect the power source while pressing CHARGE/■.

To turn on the beep sound

Remove the power source and then connect the power source without pressing CHARGE/■.

Playing your favorite tracks by adding Bookmarks (Bookmark track play)

You can add Bookmarks to up to 99 tracks for each CD. You can use this function for up to 5 CDs.

To add Bookmarks

- During playback of the track where you want to add a Bookmark, press and hold the jog lever until “” (Bookmark)” flashes in the display.

When the Bookmark has been added successfully, flashing of “” becomes slow.

- Repeat step 1 to add Bookmarks to the tracks you want.

To listen to the tracks with Bookmarks

- Press P MODE/◀ repeatedly until “” flashes.
- Press the jog lever.

“” lights up in the display and the playback of the tracks with Bookmarks starts.

To remove the Bookmarks

During playback of the track with a Bookmark, press and hold the jog lever until “” disappears from the display.

To check the tracks with Bookmarks
During playback of the tracks with Bookmarks, “” keeps flashing slowly in the display.

Notes

- During playback of the tracks with Bookmarks, tracks are played in order of track number, and not in the order you added the Bookmarks.
- If you try to add Bookmarks to the tracks on the 6th CD, the Bookmarks of the CD you played back first will be erased.
- If you remove all power sources, all Bookmarks stored in memory will be erased.
- If you continue playing the CD player on the rechargeable batteries without charging the batteries even though “Lo batt” is displayed, all Bookmarks stored in memory will be erased.

Playing tracks in your favorite order (PGM play)

You can program the CD player to play up to 64 tracks in your favorite order.

- During playback, press P MODE/↔ repeatedly until “PGM” appears.
- Flick the jog lever toward ◀◀ or ▶▶ to select a track.
- Press the jog lever to enter the selected track.

“00” appears and the playing order increases by one.

- Repeat steps 2 and 3 to select the tracks in your favorite order.

- Press and hold the jog lever until the PGM play starts.

To check the program

During programming:

Press the jog lever repeatedly before step 5.

During the PGM play:

Press P MODE/↔ repeatedly until “PGM” flashes, then press the jog lever repeatedly.

Each time you press the jog lever, the track number appears.

Notes

- When you finish entering the 64th track in step 3, the first selected track appears in the display.
- If you select more than 64 tracks, the first selected tracks are erased.

Connecting a stereo system (F)

You can listen to CDs through a stereo system and record CDs on a cassette tape. For details, see the instruction manual that comes with the connected device. Be sure to turn off all connected devices before making connections.

Notes

- Before you play a CD, turn down the volume of the connected device to avoid damaging the connected speakers.
- Use the AC power adaptor for recording. If you use the rechargeable batteries or dry batteries as a power source, batteries may become completely depleted during recording.
- Adjust the volume properly on the connected device so that the sound will not be distorted.

When using the connecting cord

If the sound is distorted, connect the device to the ⌚ jack.

About the G-PROTECTION and SOUND functions when using the connecting cord

- To record high quality CD sound, set the G-PROTECTION switch to “OFF.”
- The SOUND function works only on the output sound from the ⌚ jack and not work on the output sound from the LINE OUT jack.

Precautions

On safety

- Should any solid objects or liquid fall into the CD player, unplug it and have it checked by qualified personnel before operating it any further.
- Do not put any foreign objects in the DC IN 4.5 V (external power input) jack.

On power sources

- When you are not using the CD player for a long time, disconnect all power sources from the CD player.

On AC power adaptor

- Use only the AC power adaptor supplied. If your CD player is not supplied with the one, use the AC-E45HG AC power adaptor. Do not use any other AC power adaptor. It may cause a malfunction.

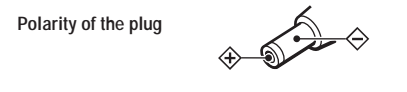

- Do not touch the AC power adaptor with wet hands.
- Connect the AC power adaptor to an easily accessible AC outlet. Should you notice an abnormality in the AC power adaptor, disconnect it from the AC outlet immediately.

On rechargeable batteries and dry batteries

- Do not charge the dry batteries.
- Do not throw the batteries into fire.
- Do not carry the batteries with coins or other metallic objects. It can generate heat if the positive and negative terminals of the battery are accidentally contacted by a metallic object.
- Do not mix rechargeable batteries with dry batteries.
- Do not mix new batteries with old ones.
- Do not use different types of batteries together.
- When the batteries are not to be used for a long time, remove them.
- If battery leakage occurs, wipe off any deposit in the battery compartment, and install new batteries. In case the deposit adheres to you, wash it off thoroughly.

On the CD player

- Keep the lens on the CD player clean and do not touch it. If you do so, the lens may be damaged and the CD player will not operate properly.
- Do not put any heavy object on top of the CD player. The CD player and the CD may be damaged.
- Do not leave the CD player in a location near heat sources, or in a place subject to direct sunlight, excessive dust or sand, moisture, rain, mechanical shock, unlevelled surface, or in a car with its windows closed.
- If the CD player causes interference to the radio or television reception, turn off the CD player or move it away from the radio or television.
- Discs with non-standard shapes (e.g., heart, square, star) cannot be played on this CD player. Attempting to do so may damage the CD player. Do not use such discs.

On headphones/earphones

Road safety

Do not use headphones/earphones while driving, cycling, or operating any motorized vehicle. It may create a traffic hazard and is illegal in some areas. It can also be potentially dangerous to play your headsets at high volume while walking, especially at pedestrian crossings. You should exercise extreme caution or discontinue use in potentially hazardous situations.

Preventing hearing damage

Avoid using headphones/earphones at high volume. Hearing experts advise against continuous, loud and extended play. If you experience a ringing in your ears, reduce volume or discontinue use.

Consideration for others

Keep the volume at a moderate level. This will allow you to hear outside sounds and to be considerate to the people around you.

Maintenance

To clean the casing

Use a soft cloth slightly moistened in water or a mild detergent solution. Do not use alcohol, benzine or thinner.

To clean the plugs

If the plugs become dirty, there is no sound or noise is heard. Clean them with a dry soft cloth periodically.

Troubleshooting

Should any problem persist after you have made these checks, consult your nearest Sony dealer.

“Hold” appears in the display when you press a button, and the CD does not play.

→The buttons are locked. Slide HOLD back.

The CD player does not start charging.
→During stop, press CHARGE/■.

The volume does not increase even if you press VOL + repeatedly.

→Press and hold SOUND until “AVLS” disappears from the display.

The battery compartment lid is detached by an accidental drop, excessive force, etc.
→Attach it as illustrated below.

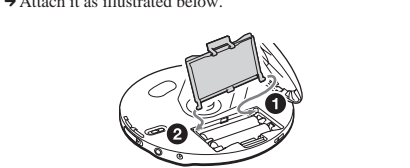

Specifications

System
Compact disc digital audio system

Laser diode properties
Material: GaAlAs
Wavelength: λ = 780 nm
Emission duration: Continuous
Laser output: Less than 44.6 μW (This output is the value measured at a distance of 200 mm from the objective lens surface on the optical pick-up block with 7 mm aperture.)

Power requirements

For the area code of the model you purchased, check the upper left side of the bar code on the package.

- Sony NH-WM2AA rechargeable batteries: 2.4 V DC
- Two LR6 (size AA) batteries: 3 V DC
- AC power adaptor (DC IN 4.5 V jack):
 - U, U2, CA, CA2, E92, MX2, TW2 and CA2/C models: 120 V, 60 Hz
 - CED, CED/4, CE7, CE7/C, EE, EE1, E, E13 and E13/2 models: 220 - 230 V, 50/60 Hz
 - CEK model: 230 V, 50 Hz
 - AU2 model: 240 V, 50 Hz
 - EU8, EU8/C, JE.W, E18, KR4 and EE8 models: 100 - 240 V, 50/60 Hz
 - HK4 model: 230 V, 50 Hz
 - CNA model: 220 V, 50 Hz

Dimensions (w/h/d) (without projecting parts and controls)

Approx. 136.0×20.7×136.0 mm (5 ³/₈× ⁷/₃₂×5 ³/₈ in.)

Mass (excluding accessories)
Approx. 170 g (6.0 oz)

Operating temperature
5°C - 35°C (41°F - 95°F)

Design and specifications are subject to change without notice.

Supplied Accessories

AC power adaptor (1)
Headphones/earphones (1)

中文

关掉操作哔声

可以关掉当操作CD播放机时在头戴耳机 / 耳机上可听到的哔声。

- 从 CD 播放机上卸下电源（AC 电源转接器，充电式电池或干电池）。
- 按着 CHARGE/■同时连接上电源。

要打开哔声时

卸下电源，然后不必按 CHARGE/■而再连接上电源。

给喜欢的曲子加记 Bookmark 以便选播（播放加记书签曲子）

每张 CD 最多能给 99 首曲子加记书签。最多能为 5 张 CD 使用此功能。

要加记 Bookmark 时

- 播放曲子当中，在所加记书签处按住微调杆至显示器中闪烁着 “” (Bookmark) ”。

当成功地加记完书签时，“” 闪烁即变慢。
- 反复步骤 1 给所有喜欢的曲子加记书签。

要利用 Bookmark 听曲子时

- 请反复按 P MODE/↔ 至闪烁着 “”。
- 按微调杆。

显示器中即点亮 “” 而开始播放带有 Bookmark（书签）的曲子。

要去除 Bookmark 时

请在播放带有 Bookmark（书签）的曲子当中，按住微调杆至显示器中的 “” 消失了显示。

要检查带有 Bookmark 的曲子时
在播放带有 Bookmark（书签）的曲子当中，显示器中的 “” 将闪烁得较慢。

注

- 在播放带有 Bookmark（书签）的曲子时，是以曲号顺序播放曲子的，而不是以您加记书签的顺序播放的。
- 您如果试图给第 6 张 CD 加记书签，则第 1 张播放的 CD 其所加记的书签，即被擦去。
- 您如果拆开了所有的电源，则储存在存储器中的所有 Bookmark 都将被擦去。
- 如果连续用充电式电池操作 CD 播放机而在显示了 “Lo batt”（电池电力弱）也不进行充电时，储存在存储器中的所有 Bookmark 也都将被擦去。

按照喜欢顺序播放曲子

（PGM（程序）播放）

可按照所喜欢顺序给CD播放机编程序去播放最多64首曲子。

- 播放中，反复按 P MODE/↔至显示 “ PGM ”。
- 向 ◀◀ 或 ▶▶ 轻按微调杆以选择曲子。
- 按微调杆以输入所选曲子。即显示 “00” 而播放序列将增加一。
- 反复步骤 2 和 3 以所喜欢顺序选择曲子。
- 按住微调杆至开始 PGM（程序）播放。

要检查程序时

编程序中：

在步骤 5 之前，反复按微调杆。

PGM（程序）播放中：

反复按 P MODE/↔至闪烁着 “ PGM ”，然后反复按微调杆。

每次按了微调杆，都将出现曲号。

注

- 在步骤 3 当您输出完第 64 曲时，显示器即出现所选第一首曲子。
- 选择 64 首以上曲子时，第一首选曲将被擦去。

连接立体声系统 (F)

可以通过立体声系统听 CD 放音或把 CD 录到盒带上。详细参看所连接装置附带的使用说明书。

连接装置以前，一定请先关掉各装置的电源开关。

注

- 要播放 CD 以前，请降低所连接装置的音量以防损坏连接着使用的扬声器。
- 请用 AC 电源转接器接电录音。如果用充电式电池或干电池电源录音，可能会在录音中途耗电电池造成不完全的录音。
- 适当调整好所连接装置的音量以免声音发生失真。

使用连接导线时

如果声音失真了，则请把装置连接到 ⌚ 插孔。

使用连接导线时的有关 G-PROTECTION 和 SOUND（声）功能

- 要录取高音质的 CD 音响时，请把G-PROTECTION 开关设定于 “ OFF ”。
- SOUND（声）功能只可在来自 ⌚ 插孔的输出声上发生作用，并不能在来自 LINE OUT 插孔的输出声上发生作用的。

使用前须注意

安全须知

- 万一有任何异物或液体掉进 CD 播放机内时，即请立刻卸下电源并找有资格的人检查过以后才可再操作使用。
- 别试图用任何物体塞入 DC IN 4.5 V（外部电源输入）插孔。

电源须知

- 当长期不使用 CD 播放机时，请卸下所有的电源。

AC 电源转接器须知

- 限使用附带的 AC 电源转接器。如果 CD 播放机没有附带 AC 电源转接器，使用 AC-E45HG AC 电源转接器。请别使用任何其他 AC 电源转接器。因为可能造成故障。

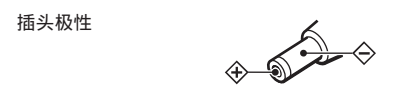

●潮湿着手不要去碰 AC 电源转接器。

- 将 AC 电源转接器接插到方便的 AC 电源插座。万一发现 AC 电源转接器有异常时，请立即从 AC 电源插座上拔下 AC 电源转接器。

充电式电池和干电池须知

- 别试图给干电池充电。
- 别把电池投入火中。
- 电池不要和硬币等别的金属小件混在一起携带。因为电池的 +、- 极若与金属件接触，将会生热造成危险。
- 别混用充电式电池和干电池。
- 别混用新、旧电池。
- 别混用不同类型的电池。
- 长时间不用电池时，请把它卸下保存。
- 电池发生漏液时，须即擦拭干净电池室里沾染的电解液，然后装用新电池。万一皮肤上沾染了漏液时，必须赶快洗净。

CD 播放机须知

- 须保持 CD 播放机上的透镜干净清洁，不要用手触摸。否则，透镜可能受损而 CD 播放机将不能操作正常。
- 别在 CD 播放机上堆置重物以免压坏 CD 播放机或 CD 光盘。
- 别把 CD 播放机放置靠近热源或可直接照射到阳光，或多沙尘、潮湿、淋到雨、有机械冲击、不平坦的地方，或紧闭着窗门的汽车里面。
- 如果 CD 播放机给附近的收音机或电视接收造成干扰，即请关掉 CD 播放机或把它移离开收音机或电视机这些使用。
- 本 CD 播放机不能用于播放不规则形（例如心形，方形，星形）的光盘。若试图那样做，将可能损坏您的 CD 播放机。切勿使用该类光盘。

头戴耳机 / 耳机须知

路上安全

开车、骑车、或在操作任何机动车辆时，请勿使用头戴耳机 / 耳机。因为可能有造成交通事故的危险。有些地区是禁止使用的。步行中如果用太大声听耳机也会有潜在危险的，尤其是在横过马路时。在有潜在危险的地方，必须特别注意或暂停使用。

防止损伤听觉

避免用大音量听头戴耳机 / 耳机。最好也不要长时间连续使用。如有耳鸣经历，更应降低音量和避免连续用耳机听。

顾虑他人

请用适当的音量听。如此则仍可听到周围的声音并且不至于骚扰到旁边的人。

保养

清洁机壳

用清水或温和的洗涤剂溶液蘸湿软布擦拭清洁，不可使用酒精、汽油或稀释剂。

清洁端子

如果端子脏了，可能听不到声音或听到噪音。定期用干的软布清洁它们。

故障检修

虽经检查过这些征候而问题仍未获解决时，即请洽询附近的 Sony 销售店。

当按按钮时，“ Hold ”出现在显示器上，不能播放 CD。
→按钮被锁定。把 HOLD 滑回原位。

CD 播放机不能充电。
→停止期间按了 CHARGE/■。

即使反复按 VOL +，音量也不提高。
→按住 SOUND 直到 “ AVLS ” 从显示器上消失。

电池室盖由于意外掉落、过大的力等而脱落。
→如下图所示把它装上。

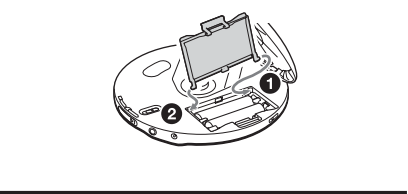

规格

系统
CD 数码音频系统

激光二极管性质
材料：GaAlAs
波长：λ=780 nm
发射持久性：连续
激光输出：小于 44.6 μW（本输出值是在距离 7 mm 光圈的光学拾音元件的物镜镜面 200 mm 处测得。）

电源

您购入型号的区域码，请查看包装上的条形码的左上角。

- 用 Sony NH-WM2AA 充电式电池：2.4 V DC
- 两 LR6（AA，5 号）电池：3 V DC
- AC 电源转接器（DC IN 4.5 V 插孔）：
 - U，U2，CA，CA2，E92，MX2，TW2 和 CA2/C 型号：120 V，60 Hz
 - CED，CED/4，CE7，CE7/C，EE，EE1，E，E13 和 E13/2 型号：220 - 230 V，50/60 Hz
 - CEK 型号：230 V，50 Hz
 - AU2 型号：240 V，50 Hz
 - EU8，EU8/C，JE.W，E18，KR4 和 EE8 型号：100 ~ 240 V，50/60 Hz
 - HK4 型号：230 V，50 Hz
 - CNA 型号：220 V，50 Hz

尺寸（宽 / 高 / 纵深）（不含突起部分和控制器）

大约 136.0×20.7×136.0 mm

重量（不含附件）
大约 170 g

操作温度
5 ~ 35

设计和规格有所变更时，恕不另行奉告。

附带的附件

AC 电源转接器 (1)
头戴耳机 / 耳机 (1)