

*Portable IC Audio Player*

# *Network Walkman*

---

Operating Instructions



"WALKMAN" is a registered trademark of Sony Corporation to represent Headphone Stereo products.

**W**•WALKMAN is a trademark of Sony Corporation.

## *NW-E75*

## WARNING

**To prevent fire or shock hazard, do not expose the unit to rain or moisture.**

Do not install the appliance in a confined space, such as a bookcase or built-in cabinet.

To prevent fire, do not cover the ventilation of the apparatus with news papers, table cloths, curtains, etc. And don't place lighted candles on the apparatus.

To prevent fire or shock hazard, do not place objects filled with liquids, such as vases, on the apparatus.

### Note on installation

If you use the unit at a place subject to static or electrical noise, the track's transferring information may be corrupted. This would prevent successful transferring authorization on your computer.

## For the customers in the United States

### Owner's Record

The model number is located in the front and the serial number is located on the rear side of the player (see page 8). Record the serial number in the space provided below.

Refer to them whenever you call your Sony dealer regarding this product.

Model No. \_\_\_\_\_

Serial No. \_\_\_\_\_

### INFORMATION:

This equipment has been tested and found to comply with the limits for a Class B digital device, pursuant to Part 15 of the FCC Rules. These limits are designed to provide reasonable protection against harmful interference in a residential installation. This equipment generates, uses, and can radiate radio frequency energy and, if not installed and used in accordance with the instructions, may cause harmful interference to radio communications.

However, there is no guarantee that interference will not occur in a particular installation. If this equipment does cause harmful interference to radio or television reception, which can be determined by turning the equipment off and on, the user is encouraged to try to correct the interference using one or more of the following measures:

- Reorient or relocate the receiving antenna.
- Increase the separation between the equipment and receiver.
- Connect the equipment into an outlet on a circuit different from that to which the receiver is connected.
- Consult the dealer or an experienced radio/TV technician for help.

You are cautioned that any changes or modifications not expressly approved in this manual could void your authority to operate this equipment.

If you have any questions about this product:

Visit: [www.sony.com/walkmansupport](http://www.sony.com/walkmansupport)

Contact: Sony Customer Information Services Center at (866)-456-7669

Write: Sony Customer Information Services Center  
12451 Gateway Blvd..  
Fort Myers, FL33913

## Declaration of Conformity

Trade Name: SONY  
Model No.: NW-E75  
Responsible Party: Sony Electronics Inc.  
Address: 16450 W. Bernardo Dr,  
San Diego, CA 92127  
USA  
Telephone Number: 858-942-2230

This device complies with Part 15 of the FCC Rules. Operation is subject to the following two conditions: (1) This device may not cause harmful interference, and (2) this device must accept any interference received, including interference that may cause undesired operation.

## Notice for users

### On the supplied software

- Copyright laws prohibit reproducing the software or the manual accompanying it in whole or in part, or renting the software without the permission of the copyright holder.
- In no event will SONY be liable for any financial damage, or loss of profits, including claims made by third parties, arising out of the use of the software supplied with this player.
- In the event a problem occurs with this software as a result of defective manufacturing, SONY will replace it.  
However, SONY bears no other responsibility.
- The software provided with this player cannot be used with equipment other than that which is so designated.
- Please note that, due to continued efforts to improve quality, the software specifications may be changed without notice.
- Operation of this player with software other than that provided is not covered by the warranty.

Program ©2001, 2002, 2003, 2004 Sony Corporation  
Documentation ©2004 Sony Corporation

This manual explains how to operate your Network Walkman. For details on how to use the SonicStage (supplied software), refer to the SonicStage operating instructions.

OpenMG and its logo are trademarks of Sony Corporation.

SonicStage and its logo are trademarks of Sony Corporation.

ATRAC, ATRAC3, ATRAC3plus and their logos are trademarks of Sony Corporation.

Microsoft, Windows and Windows Media are trademarks or registered trademarks of Microsoft Corporation in the United States and/or other countries.

US and foreign patents licensed from Dolby Laboratories.

All other trademarks and registered trademarks are trademarks or registered trademarks of their respective holders.

In this manual,™ and © marks are not specified.

# Table of Contents

## Overview

What you can do with your Network Walkman .....	6
Other features .....	7
Step 1: Checking the package contents .....	8
Step 2: Inserting the battery .....	9
Locating controls .....	10
Front side .....	10
Rear side .....	10
Display .....	11

## Basic Operations

Transferring audio files from the computer to your Network Walkman .....	12
Note on playing songs with a limited playing period (Timeout contents) ...	13
Note on playing songs with a limited playing count .....	13
Listening to music with your Network Walkman .....	14
What is the Group function? .....	15
On other operations .....	16

## Advanced Operations

Repeat mode .....	17
Selecting the repeat mode .....	17
Playing the tracks repeatedly (Track Repeat) .....	18
Playing a specified section repeatedly (A-B Repeat) .....	18
Playing specified sentences repeatedly (Sentence Repeat) .....	19
Setting the repeat counts .....	20
Changing the display mode .....	21
Selecting the group display mode .....	22
Adjusting treble and bass (Digital sound preset) .....	22
Selecting the Sound quality .....	22
Adjusting the sound quality .....	23
Locking the controls (HOLD) .....	24
Storing non-audio data .....	24

## Adjusting the settings of your Network Walkman

Adjusting the time setting of your Network Walkman to a computer's built-in clock .....	25
Adjusting the current time setting (DATE-TIME) .....	26
Limiting the volume (AVLS) .....	27
Setting the volume using the preset volume function .....	28
Setting a volume level of the preset mode .....	28
Switching to the manual mode .....	29
Turning off the beep sound (BEEP) .....	30
Changing the backlight setting .....	31

## Other functions

Regrouping songs (REGROUP) .....	32
Formatting memory (FORMAT) .....	33

## Other Information

Precautions .....	34
Troubleshooting .....	35
To reset the player .....	35
What happened? .....	35
Messages .....	38
Specifications .....	40
Glossary .....	41
Menu list .....	43
Index .....	44

# Overview

## What you can do with your Network Walkman

First, you need to install the “SonicStage” software into your computer. You can easily transfer digital audio files from your computer to the built-in flash memory and carry it anywhere to enjoy.

### 1 Store digital audio files on your computer.

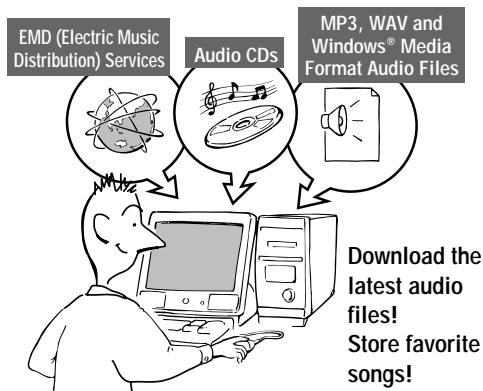

### 2 Transfer files to your Network Walkman.

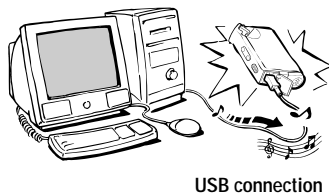

### 3 Enjoy music with your Network Walkman.



---

## Other features

- Compact size, light weight, skip-proof operation, high portability.
- Continuous playback time with a battery  
Approximately 70\*<sup>1</sup> hours
- Recording time\*<sup>2</sup>  
256MB built-in flash memory, more than 11 hours 40 minutes.
- The supplied SonicStage software enables you to record songs from audio CDs to the hard disk of your computer using the ATRAC3plus format (high sound quality, high compression).
- Sentence Repeat: Useful function for learning a foreign language.
- High-speed data transfer using the dedicated USB cable.
- Backlight LCD screen: song titles and artist names can be displayed.
- Group function: you can select songs to be played by album.
- Storage function: you can store a variety of data as well as audio files.

\*<sup>1</sup> Differs according to the data format. In this case, the figure for the battery duration is when continuously playing ATRAC3 format audio files.

\*<sup>2</sup> Differs according to the bit rate when recording. In this case, the figure for the recordable time is when recording at 48kbps ATRAC3plus format.

### NOTES:

- The recorded music is limited to private use only. Use of the music beyond this limit requires permission of the copyright holders.
- Sony is not responsible for incomplete recording/downloading or damaged data due to problems of the Network Walkman or computer.

# Step 1: Checking the package contents

Please check the accessories in the package.

- Network Walkman (1)
- Headphones (1)

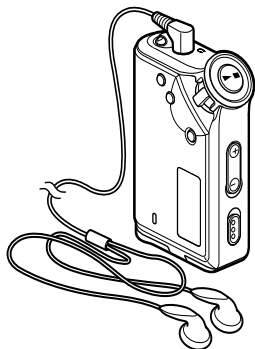

- Dedicated USB cable (1)

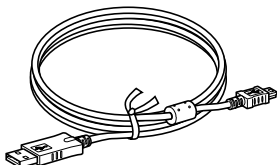

- CD-ROM (1)
- Operating instructions (1)
- SonicStage operating instructions (1)

## About the Serial Number

The serial number provided for your device is required for the customer registration. The number is on the rear side of your Network Walkman.

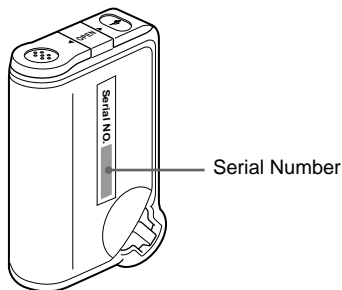

Record the serial number in the space provided below. Refer to it whenever you call upon your Sony dealer regarding this product.

Serial No. \_\_\_\_\_



## Step 2: Inserting the battery

Insert the size AAA (LR03) alkaline battery with correct polarity. Be sure to insert it from the  side as illustrated.

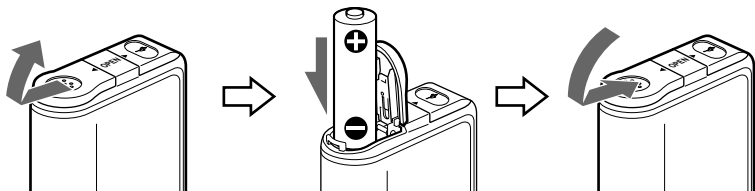

### **Battery duration\***

ATRAC3 format: Approximately 70 hours

ATRAC3plus format: Approximately 60 hours

\* The battery life may be shorter due to operating conditions and the temperature of the location.

### **On the remaining battery indication**

The battery icon in the display changes as shown below.

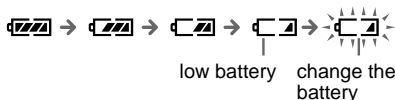

If “LOW BATT” is displayed in the display, you need to change the battery.

If the battery compartment lid is accidentally detached, attach it as illustrated.

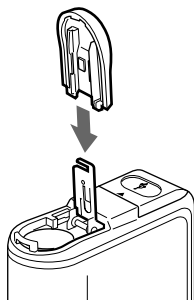

### **Notes**

If you do not use the battery correctly, it may become damaged from leakage and corrosion. For best results:

- Use the alkaline battery.
- Make sure the polarity is correct.
- Do not charge a dry cell battery.
- Remove the battery, if you do not intend to use the player for an extended period of time.
- If you have battery leakage, replace with a new battery after cleaning the battery compartment.

# Locating controls

For details about each part, refer to the pages in parentheses.

## Front side

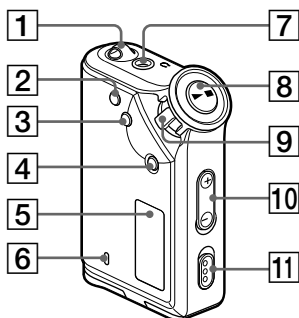

- 1** Strap hole for attaching the strap
- 2** REPEAT/SOUND button  
(page 18 to 19, 22)
- 3** MENU button (page 17, 19 to 21, 23, 25 to 33)  
You can switch to the Time display by pressing the MENU button for a while.
- 4** GROUP button (page 15, 19 to 20, 22)
- 5** Display (page 11, 18, 38)  
For details on the display and icons, refer to page 11.
- 6** ACCESS lamp (page 12)

## Rear side

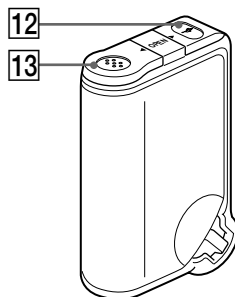

- 7** Headphone jack (page 14)
- 8** ►■ button  
(page 14, 16 to 21, 23, 25 to 33)
- 9** Shuttle switch  
(page 16 to 21, 23, 25 to 33)
- 10** VOLUME +/- button (page 14, 28)
- 11** HOLD (Locking controls) switch  
(page 14, 24)
- 12** USB jack (page 12)
- 13** Battery compartment (page 9)

# Display

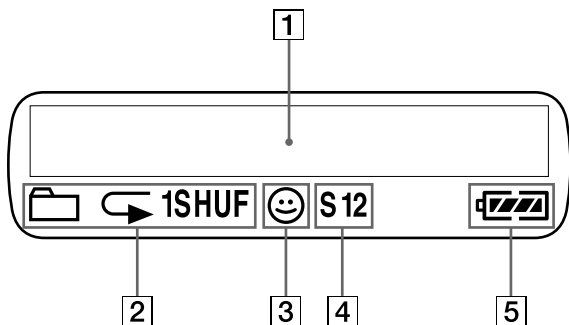

- 1** Text/graphic information display (page 17)

Displays track number, track name, current date and time (page 21 to 27), MESSAGE (page 13, 38) and menu. Press the MENU button to switch the display mode. For details, refer to “Changing the display mode” on page 21.

- 2** Repeat mode indication (page 18)

The current repeat mode is displayed.

- 3** AVLS indication (page 27)

The indication appears while the AVLS function is activated.

- 4** Digital sound preset indication (page 22 to 23)

The current sound setting is displayed.

- 5** Remaining battery indication (page 9)

The remaining battery power is displayed.

# Basic Operations

## Transferring audio files from the computer to your Network Walkman

### Note

Before connecting your Network Walkman to the computer for the first time, be sure to install the “SonicStage” software from the supplied CD-ROM in your computer. Even if the SonicStage software is already installed, you need to install the SonicStage software supplied with this Network Walkman before connecting your Network Walkman to the computer (update programs may be available).

### 1 Install the SonicStage software in your computer using the supplied CD-ROM.

Follow step 1 only for the first time when you connect your Network Walkman to the computer.

For details, refer to the SonicStage operating instructions.

### 2 Import audio files into the SonicStage software.

For details, refer to the manual “SonicStage operating instructions.”

### 3 Connect your Network Walkman to your computer.

Connect the small connector of the dedicated USB cable into the USB jack on the Network Walkman, then the large connector to a USB port on your computer.

“CONNECT” appears in the display.

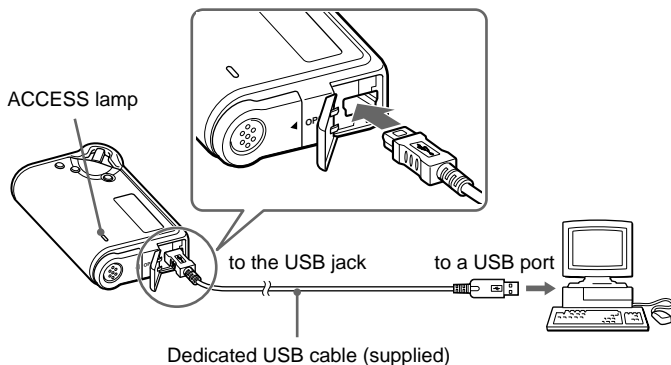

**Notes**

- The ACCESS lamp blinks while your Network Walkman accesses the computer.
- Do not disconnect the USB cable when the ACCESS lamp is blinking. The data being transferred may be destroyed.
- Use of your Network Walkman with a USB hub or a USB extension cable is not guaranteed. Always connect your Network Walkman to the computer directly using the dedicated USB cable.
- Some USB devices connected to the computer may interfere with the proper operation of your Network Walkman.
- The control buttons on your Network Walkman are all disabled while it is connected to a computer.
- You can display the data stored in the built-in flash memory using Windows Explorer when your Network Walkman is connected to the computer.

---

## 4 Transfer audio files to your Network Walkman.

For information on transferring audio files to the built-in flash memory, refer to the separate manual “SonicStage operating instructions.”

---

 **Tip**

For information on transferring audio files back to the computer, refer to the manual “SonicStage operating instructions” or online Help for the SonicStage software.

## Note on playing songs with a limited playing period (Timeout contents)

Some songs distributed via the Internet (EMD service) have a limited playing period.

If you try to play an expired song, “EXPIRED” blinks and the next song will be played after a moment.

In addition, an expired song cannot be played using the SonicStage software, or transferred to your Network Walkman. Delete any songs as needed.

## Note on playing songs with a limited playing count

Your Network Walkman does not support contents with a limited playing count.

When you try to play a song with a limited playing count, “EXPIRED” will be displayed and the song will not be played.

# Listening to music with your Network Walkman

Please insert the battery before use (see page 9).

## Note

When using Network Walkman, be sure do disconnect it from the computer.

## 1 Connect the headphones.

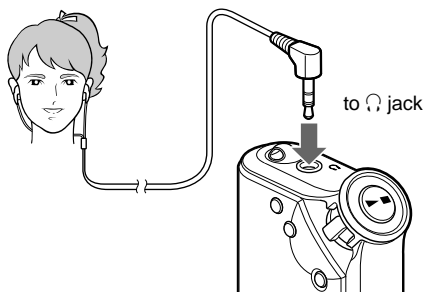

## 2 Start playback.

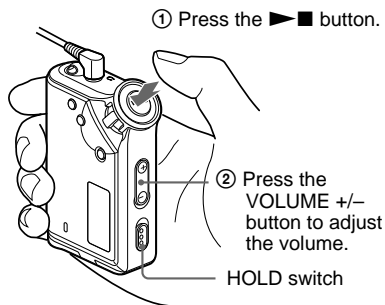

When the normal playback mode is selected, playback stops automatically after the last song is played.

### **If playback does not start**

Make sure that the HOLD switch is set to off (page 24).

### **To stop playback**

Press the play/pause button.

### **To adjust the volume**

The volume can be set in the PRESET and MANUAL mode (page 28 to 29).

## Tip

If your Network Walkman is not operated for 10 seconds while in stop mode, the display automatically turns off.

When scrolling track titles, etc., the display turns off after scrolling is finished.

## What is the Group function?

The Group function enables you to select favorite music conveniently on your Network Walkman. You can transfer to audio files or play songs by album or artist using the Group function.

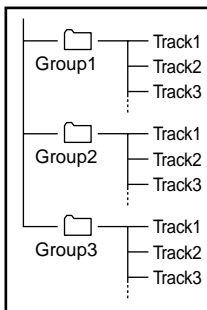

- The track number is the order of songs in each group.
- You can switch between Track Name mode and Group mode by pressing the GROUP button.
- In the Group mode, group names are displayed instead of track names. In addition, any shift operations, such as Skip or Repeat, are performed by group.

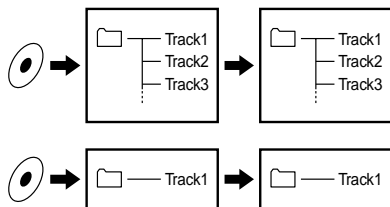

### ***Transferring by group***

The audio files transferred to the SonicStage software are always grouped when transferred to the built-in flash memory.

continued

## On other operations

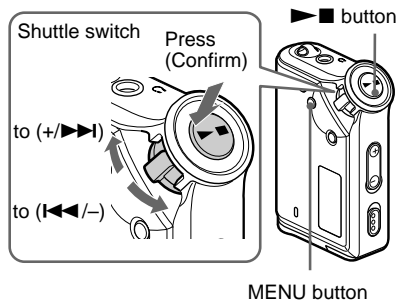

### Tip

You can switch to the Group mode by pressing the Group mode button.

To	Shuttle switch operation
Skip to the beginning of the next track/group* <sup>1</sup>	Rotate the Shuttle switch clockwise once (+/▶▶).
Skip to the beginning of the current track/group* <sup>1</sup>	Rotate the Shuttle switch counterclockwise once (◀◀/-).
Fast-forward* <sup>2</sup>	Rotate the Shuttle switch clockwise (+/▶▶) and hold it.
Fast-rewind* <sup>2</sup>	Rotate the Shuttle switch counterclockwise (◀◀/-) and hold it.

\*<sup>1</sup> Rotating and holding of the Shuttle switch during stop mode allows you to skip to the beginning of the next (current and previous) track/group continuously.

\*<sup>2</sup> Fast-forward and fast-rewind speed become faster if the operation is continued for five seconds.



## ► Advanced Operations

# Repeat mode

There are three types of repeat mode: Track Repeat, A-B Repeat and Sentence Repeat.

### • Track Repeat (TRK Rep)

This mode plays back tracks repeatedly in the following five ways.

Track Repeat mode	Operation
All Repeat	All tracks repeatedly
Single Repeat	Current track repeatedly
Group Repeat	Current group repeatedly
Group Shuffle Repeat	Current group repeatedly in random order
All Groups Shuffle Repeat	All groups repeatedly in random order

### • A-B Repeat (A-B Rep)

This mode plays back the specified section in a track repeatedly.

### • Sentence Repeat (SENTENCE Rep)

This mode plays back voice data within a specified section in a track repeatedly.

## Selecting the repeat mode

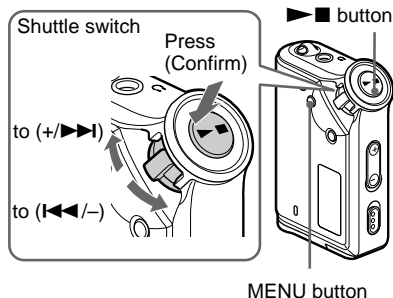

### 1 Press the MENU button in stop mode.

The menu screen is displayed.



### 2 Rotate the Shuttle switch to select "REPEAT MODE >" and press the ► button to confirm.

### 3 Rotate the Shuttle switch to select a desired repeat mode and press the ► button to confirm.



You can choose one mode among "TRK Rep," "A-B Rep" and "SENTENCE Rep."

### 4 Press the MENU button.

The display returns to the normal screen.

You can operate each repeat mode you selected, as refer to the below.

- TRK Rep: see "Playing the tracks repeatedly (Track Repeat)."
- A-B Rep: see "Playing a specified section repeatedly (A-B Repeat)."
- SENTENCE Rep: see "Playing specified sentences repeatedly (Sentence Repeat)."

### To cancel the Menu mode

Select [RETURN] in the menu screen or press the MENU button.

continued

## Repeat mode

### Notes

- The display automatically returns to the normal playback screen if you do not operate any button for 60 seconds.
- When there is no audio files in the built-in flash memory, you cannot set any repeat mode.
- When you connect the Network Walkman to your computer, the selected desired mode will be cancelled.
- You can select repeat mode only in stop mode.

## Playing the tracks repeatedly (Track Repeat)

The Track Repeat mode is changed by pressing the REPEAT/SOUND button. You can check the current Track Repeat mode with the icon of the display.

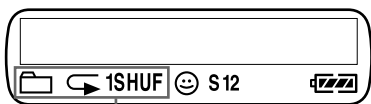
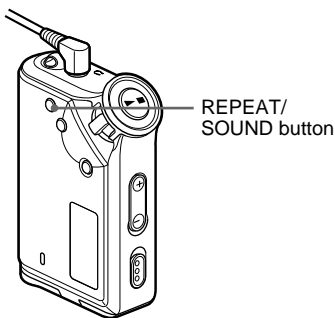

Track Repeat icon

Select the Track Repeat mode (TRK Rep) first (page 17). Then, press the REPEAT/SOUND button repeatedly to select the repeat mode you want.

Each press changes the Track Repeat icon as follows:

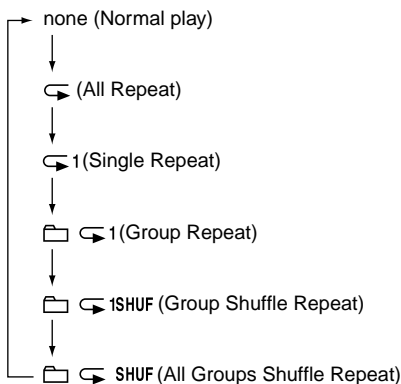

## Playing a specified section repeatedly (A-B Repeat)

While playing a track, you can set the start point (A) and end point (B) for a section you wish to play repeatedly.

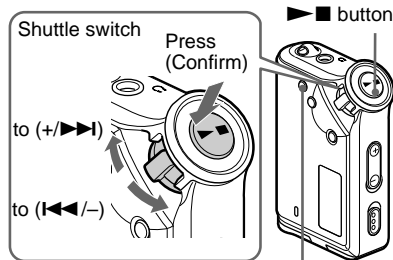

REPEAT/SOUND button

1 Select the A-B Repeat mode (A-B Rep) (page 17).

2 Press the **▶■** button to start playback.

3 Press the REPEAT/SOUND button to set the start point (A) while playing back.

“B” blinks.

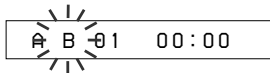

4 Press the REPEAT/SOUND button to set the end point (B).

“A B” is displayed and the specified section is played back repeatedly.

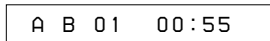

### Notes

- You cannot set A-B Repeat for a section that overlaps two or more tracks.
- If you do not set the end point (B), the end point is automatically set at the end of the track.
- You cannot use A-B Repeat in the Group mode or when the current time is displayed.

### 💡 Tips

- You can fast-forward or fast-rewind by rotating the Shuttle switch, after the start point (A) is set. If the track reaches the end while fast-forwarding, the end point is set as point (B) and fast-forwarding continues. A-B Repeat starts when you release the Shuttle switch. If the track reaches the beginning while fast-rewinding, it jumps to the end of the track, the end point is set as point (B), and fast-rewinding continues.
- You can fast-forward or fast-rewind by rotating the Shuttle switch, during A-B Repeat playback. If the track reaches the track start/end while fast-forwarding or fast-rewinding, playback is stopped (enters Standby). A-B Repeat restarts when you release the Shuttle switch.

**To clear the start point (A) and end point (B)**

- Press the REPEAT/SOUND button during A-B Repeat playback.
- Press the MENU button during A-B Repeat playback.
- Select the Group mode by pressing the GROUP button during A-B Repeat playback.
- Select the previous or next track by rotating the Shuttle switch during A-B Repeat playback. (The A-B Repeat mode is not canceled.)

**To cancel the A-B Repeat mode**

Change the Repeat mode in the menu screen (page 17).

## Playing specified sentences repeatedly (Sentence Repeat)

This function automatically detects only voice data from the setting point and repeats the voice data for setting counts. It is useful for learning a foreign language.

### 💡 Tip

The default repeat counts setting is 2 times for one sentence. But you can change the repeat counts setting. Refer to “Setting the repeat counts” on page 20.

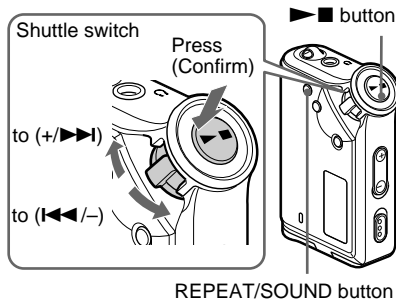

1 Select the Sentence Repeat mode (SENTENCE Rep) (page 17).

continued

## Repeat mode

- Press the **▶■** button to start playback.
- Press the **REPEAT/SOUND** button to place the setting point during playback.

The Network Walkman detects spoken sections and non-spoken sections from the set point, and Sentence Repeat starts. (The spoken section is repeated once (during detection), and the setting is counted.)

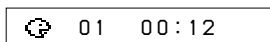

### Notes

- You cannot use Sentence Repeat in the Group mode, or when the current time is displayed.
- A spoken or non-spoken section of less than 1 second will not be detected.
- If a non-spoken section is not detected until the track end, the track end point is recognized as a non-spoken section and Sentence Repeat begins from the previous spoken section.

### To clear the setting point

- Press the REPEAT/SOUND button during Sentence Repeat playback.
- Press the MENU button during Sentence Repeat playback.
- Select the Group mode by pressing the GROUP button during Sentence Repeat playback.
- Select the previous or next track by rotating the Shuttle switch during Sentence Repeat playback.

(The Sentence Repeat mode is not canceled.)

### To cancel the Sentence Repeat mode

Change the Repeat mode in the menu screen (page 17).

## Setting the repeat counts

You can set the repeat counts (1-9) of one sentence for the Sentence Repeat mode.

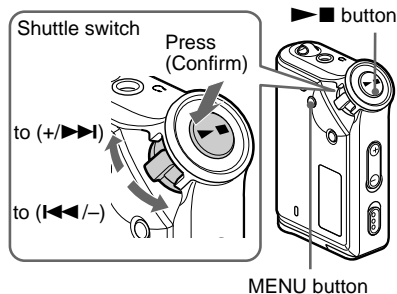

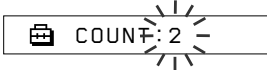
- Press the **MENU** button.  
The menu screen is displayed.  

- Rotate the Shuttle switch to select **"REPEAT MODE >"** and press the **▶■** button to confirm.
- Rotate the Shuttle switch to select **"SENTENCE Rep"** and press the **▶■** button to confirm.  
"COUNT:" is displayed on the screen.  

- Rotate the Shuttle switch to select a desired repeat counts and press the **▶■** button to confirm.
- Press the **MENU** button.  
The display returns to the normal screen.

### To cancel the Menu mode

Select [RETURN] in the menu screen or press the MENU button.

## Changing the display mode

You can view information such as track numbers or titles in the display while music is played or stopped. Change the display mode by operating the Shuttle switch in the Menu mode.

- Lap Time: Elapsed time display mode

The following will be displayed after a music title and artist name are displayed.

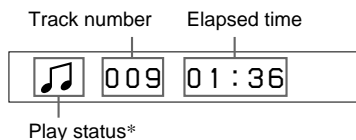

- \* Play: Displays and alternately.
- Stop: Displays .
- Search track: Displays or .
- Fast-forward/Fast-rewind: Displays or .

- Title: Title display mode

When the music title includes more than 12 characters, the title will be automatically scrolled.

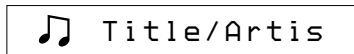

- Track info: Track information display mode

The track title, CODEC, and bit rate are displayed. When the information includes more than 12 characters, the information will be automatically scrolled.

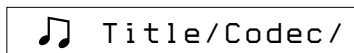

While searching, fast-forwarding, or fast-rewinding a track, the current playing position is displayed.

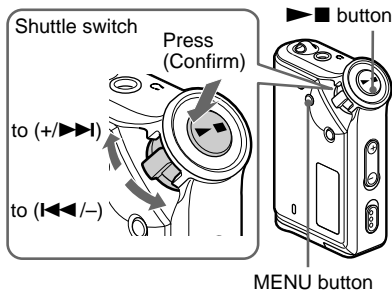

- 1 Press the MENU button.

The menu screen is displayed.



- 2 Rotate the Shuttle switch to select "DISPLAY >" and press the button to confirm.

The selected display mode blinks.

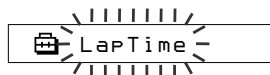

- 3 Rotate the Shuttle switch to select a desired display mode and press the button to confirm.

The display switches to the selected display mode.



- 4 Press the MENU button.

The display returns to the normal screen.

### To cancel the menu mode

Select [RETURN] in the menu screen or press the MENU button.

continued

## Changing the display mode

### Note

The display automatically returns to the normal playback screen if you do not press any buttons for 60 seconds.

## Selecting the group display mode

For any menu mode, you can select the group display by pressing the GROUP button.

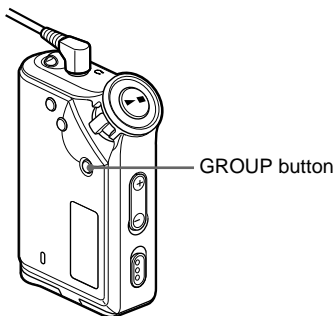

### To cancel the group mode

Press the GROUP button in the group mode screen.

### Note

The display automatically returns to the normal playback screen if you do not operate any button for 30 seconds.

## Adjusting treble and bass (Digital sound preset)

You can adjust the treble and bass. You can preset two settings, which can be selected during playback.

## Selecting the Sound quality

### Default settings

Sound quality	SOUND 1 (S1)	SOUND 2 (S2)	SOUND OFF (NORMAL SOUND)
Bass	+1	+3	$\pm 0$
Treble	$\pm 0$	$\pm 0$	$\pm 0$

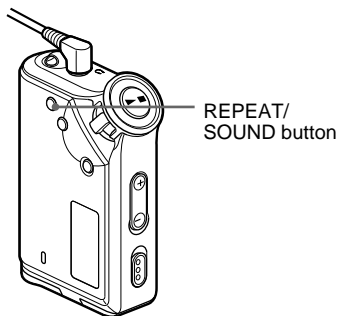

### Press and hold the REPEAT/SOUND button for half a second.

The Sound quality setting is changed as follows:

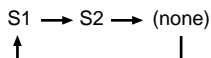

### To return to the normal Sound quality

Select "SOUND OFF."

## Adjusting the sound quality

You can adjust the sound quality of bass and treble parts.

Sound quality	Emphasis level
Bass	-4 to +3
Treble	-4 to +3

You can preset desired sound quality settings as “Sound 1” and “Sound 2.” While playing music, you can assign a preset sound quality to music.

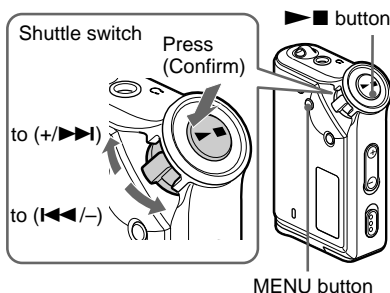

### 1 Press the MENU button.

The menu screen is displayed.

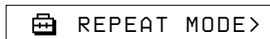

### 2 Rotate the Shuttle switch to select “SOUND >” and press the ▶■ button to confirm.

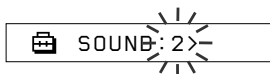

### 3 Set the tone for “SOUND 1.”

- ① Rotate the Shuttle switch to select “SOUND 1 >” and press the ▶■ button to confirm.
- ② “BASS:+1” appears, rotate the Shuttle switch to adjust the emphasis level of bass sound and press the ▶■ button to confirm.
- ③ “TREBLE: 0” appears, rotate the Shuttle switch to adjust the emphasis level of treble sound and press the ▶■ button to confirm.

### 4 Press the MENU button

The display returns to the normal screen.

#### *To adjust the “SOUND 2” setting*

Select “SOUND 2” in step 3.

#### *To cancel the menu mode*

Select [RETURN] in the menu screen or press the MENU button.

---

## Locking the controls (HOLD)

You can protect your Network Walkman against accidental operation by using the HOLD function when carrying it.

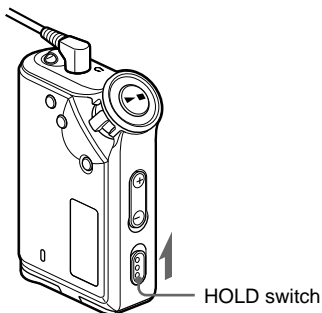

### **Slide the HOLD switch in the direction of the arrow.**

All operation buttons are disabled.

If you press buttons while the HOLD switch is on, "HOLD" blinks in the display.

### ***To release the HOLD function***

Slide the HOLD switch in the opposite direction of the arrow.

---

## Storing non-audio data

You can transfer data from the hard disk of your computer to the built-in flash memory using Windows Explorer.

The built-in flash memory is displayed in Windows Explorer as an external drive (for example: as the D drive).

### **Notes**

- You cannot operate the SonicStage software while operating the data storage function of your Network Walkman to use files stored in the built-in flash memory. The error message "Cannot access the Device/media." will be displayed when you try to operate both of them simultaneously.
- If you store a lot of non-audio data into the built-in flash memory, the space for audio data is reduced by the same amount.



▶ *Adjusting the settings of your Network Walkman*

## Adjusting the time setting of your Network Walkman to a computer's built-in clock

If the function is set to "ON," the time setting of your Network Walkman is automatically adjusted to the computer's built-in clock when your Network Walkman is connected and audio file transferring is executed (the SonicStage software must be started). "ON" is selected by default.

You cannot play a song with a limited playing period without the time setting of your Network Walkman. Be sure to adjust the time setting.

To set the date and time on your Network Walkman, refer to "Adjusting the current time setting (DATE-TIME)" on page 26.

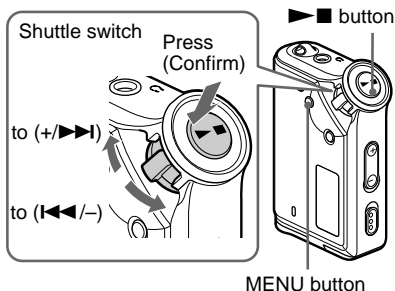

### Changing the setting to "OFF"

The time setting of your Network Walkman does not change even when your Network Walkman is connected to a computer.

#### 1 Press the MENU button.

The menu screen is displayed.



#### 2 Rotate the Shuttle switch to select "PC CLK:" and press the ► button to confirm.



#### 3 Rotate the Shuttle switch to select "OFF" and press the ► button to confirm.

#### 4 Press the MENU button

The display returns to the normal screen.

### To change the setting to "ON"

Select "ON" in step 3.

### To cancel the menu mode

Select [RETURN] in the menu screen or press the MENU button.

# Adjusting the current time setting (DATE-TIME)

You can set and display the current time.

You can also adjust the time setting of your Network Walkman to a computer's built-in clock by connecting your Network Walkman to the computer (page 25).

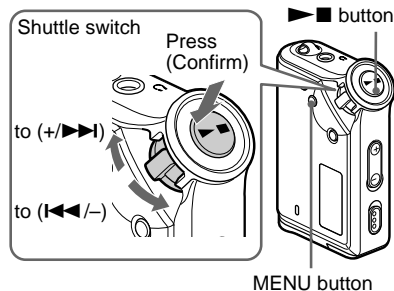

## 1 Press the MENU button.

The menu screen is displayed.



## 2 Rotate the Shuttle switch to select "DATE-TIME" and press the ► button to confirm.

The "year" digit blinks.

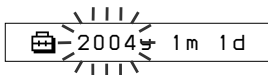

## 3 Rotate the Shuttle switch to adjust the "year" setting and press the ► button to confirm.

The "month" digit blinks.

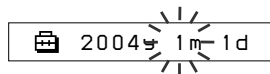

## 4 As you did in step 3, adjust the settings for "month" and "date."

After rotating the Shuttle switch to adjust the "date" setting and pressing the ► button to confirm, the display switches to the time setting screen.

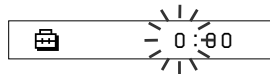

## 5 Rotate the Shuttle switch to adjust the "hour" setting and press the ► button to confirm.

The "minute" digit blinks.



## 6 As you did in step 5, adjust the settings for "minute."

After rotating the Shuttle switch to adjust the "minute" setting and pressing the ► button to confirm, the display switches to the time setting screen.



## 7 Press the MENU button.

The display returns to the normal screen.

### To cancel the menu mode

Select [RETURN] in the menu screen or press the MENU button.

### To display the current time

Press the MENU button and hold it. You can display the current time while pressing the button.

#### Notes

- If the unit is not used for a long time, your settings of the date and time may be reset.
- If the current time is not set, the display for the date and time will be "-- --."
- If PC CLK is set to "ON" (page 25), the time setting of your Network Walkman is automatically adjusted to a computer's built-in clock when your Network Walkman is connected to the computer.
- Depending on the shipping area, the time display format of the unit is set to a 12-hour display or a 24-hour display.

You cannot switch between a 12-hour display and a 24-hour display in the unit.

A 24-hour display is shown in this manual.

## Limiting the volume (AVLS)

You can set AVLS (Automatic Volume Limiter System) to limit the maximum volume to prevent auditory disturbance or distraction. With AVLS, you can listen to music at a comfortable volume level.

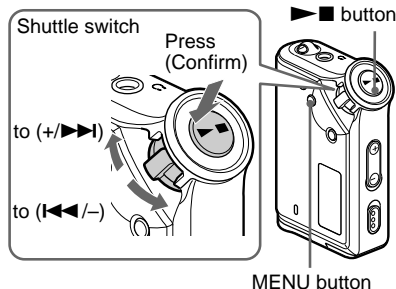

### 1 Press the MENU button.

The menu screen is displayed.



### 2 Rotate the Shuttle switch to select "AVLS" and press the ► button to confirm.

"OFF" blinks.



### 3 Rotate the Shuttle switch to select "ON" and press the ► button to confirm.

The ☺ (AVLS) indication is displayed. The volume is kept at a moderate level.

### 4 Press the MENU button.

continued

## Limiting the volume (AVLS)

### To change the setting to “OFF”

Select “OFF” in step 3.

### To cancel the menu mode

Select [RETURN] in the menu screen, or press the MENU button.

## Setting the volume using the preset volume function

There are two modes to adjust the volume level.

**Manual mode:** Press the VOLUME +/- button to adjust the volume level in the range of 0 to 31.

**Preset mode:** Press the VOLUME +/- button to set the volume level to any of three preset levels: LO, MID, or HI.

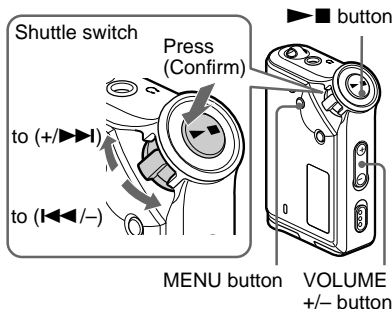

## Setting a volume level of the preset mode

### 1 Press the MENU button.

The menu screen is displayed.



### 2 Rotate the Shuttle switch to select “VOL: MAN.”

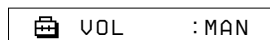

- 
- 3 Press the ►■ button to confirm.**  
“MAN” blinks.

- 
- 4 Rotate the Shuttle switch to select “SET >.”**

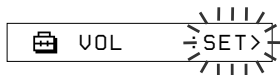

- 
- 5 Press the ►■ button to confirm.**  
“VOL LO xx”\* blinks.

\* “xx” stands for numeric values of the volume level.



- 
- 6 Set volume levels of three preset levels: LO, MID, or HI.**

- ① Press the VOLUME +/- button to set the volume level of the LO preset.
- ② Rotate the Shuttle switch to select “VOL MID xx,” and then press the VOLUME +/- button to set the volume level of the MID preset.
- ③ Rotate the Shuttle switch to select “VOL HI xx,” and then press the VOLUME +/- button to set the volume level of the HI preset.

- 
- 7 Press the ►■ button to confirm.**

- 
- 8 Press the MENU button.**

The display returns to the normal screen. With these settings, you can adjust the volume level to any of three preset levels: LO, MID, or HI.

---

### **To cancel the menu mode**

Select [RETURN] in the menu screen or press the MENU button.

### **Note**

If AVLS (page 27) is set, the actual volume may be lower than the settings.

---

## Switching to the manual mode

- 
- 1 Press the MENU button.**  
The menu screen is displayed.

- 
- 2 Rotate the Shuttle switch to select “VOL: SET.”**

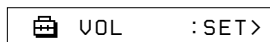

- 
- 3 Press the ►■ button to confirm.**  
“SET >” blinks.

- 
- 4 Rotate the Shuttle switch to select “MAN.”**

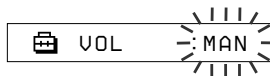

- 
- 5 Press the ►■ button to confirm.**

- 
- 6 Press the MENU button.**  
The display returns to the normal screen. With this setting, you can adjust the volume level by pressing the volume button.

---

## Turning off the beep sound (BEEP)

You can turn off the beep sounds of your Network Walkman.

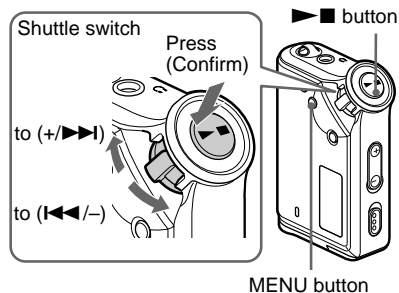

### **To change the setting to “ON”**

Select “ON” in step 3.

### **To cancel the menu mode**

Select [RETURN] in the menu screen, or press the MENU button.

---

#### **1 Press the MENU button.**

The menu screen is displayed.

REPEAT MODE >

---

#### **2 Rotate the Shuttle switch to select “BEEP:” and press the ▶■ button to confirm.**

“ON” blinks.

BEEP: ON

---

#### **3 Rotate the Shuttle switch to select “OFF” and press the ▶■ button to confirm.**

BEEP: OFF

---

#### **4 Press the MENU button.**

The display returns to the normal screen.

---

# Changing the backlight setting

You can select ON or OFF.

Menu	Backlight mode
OFF	Always off
ON	Turns on for three seconds after each operation (or until scrolling is complete)

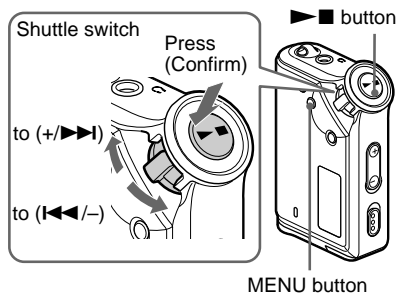

## To set "ON"

### 1 Press the MENU button.

The menu screen is displayed.

 REPEAT MODE >

### 2 Rotate the Shuttle switch to select "LIGHT:" and press the button to confirm.

"OFF" blinks.

 LIGHT: OFF

### 3 Rotate the Shuttle switch to select "ON" and press the button to confirm.

 LIGHT: ON

### 4 Press the MENU button.

The display returns to the normal screen.

### To change the setting to "OFF"

Select "LIGHT: OFF" in step 3.

### To cancel the menu mode

Select [RETURN] in the menu screen or press the MENU button.

## Regrouping songs (REGROUP)

The songs group function may be disabled\* when a song has been deleted from or added the built-in flash memory by operating the computer in which the SonicStage software is not installed (page 12). In such a case, you may enable the group function by regrouping audio file. When you need to edit audio file, make sure that you connect your Network Walkman to the computer and use the SonicStage software.

\* The order of songs will not be changed even if the song group function is disabled.

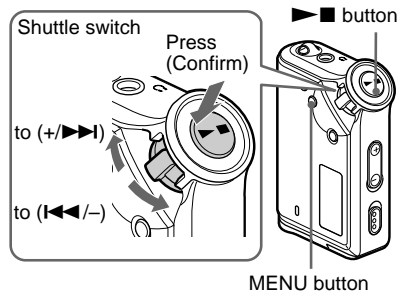

### 1 Press the MENU button.

The menu screen is displayed.

 REPEAT MODE >

### 2 Rotate the Shuttle switch to select "REGROUP" and press the ▶■ button to confirm.

 REGROUP : N

You cannot regroup audio file while playing music.

### 3 Rotate the Shuttle switch to select "Y" and press the ▶■ button to confirm.

"Really?" is displayed.

 Really?

### 4 Press the ▶■ button.

Regrouping starts and "REGROUPING" blinks. When regrouping audio file is complete, "COMPLETE" is displayed and the display returns to the indication in step 2.

### 5 Press the MENU button.

The display returns to the normal screen.

#### To cancel the menu mode

Select [RETURN] in the menu screen or press the MENU button.

#### Note

You cannot regroup songs while playing music. ("REGROUP" will not be displayed in the menu screen.)

#### Tip

In some cases, you may not be able to restore the former grouping. When you need to edit audio file, connect your Network Walkman to the computer and use the SonicStage software.



# Formatting memory (FORMAT)

You can use your Network Walkman to format the built-in flash memory.

If memory is formatted, all data previously stored in the memory will be erased. Be sure to verify the data stored in the memory prior to formatting.

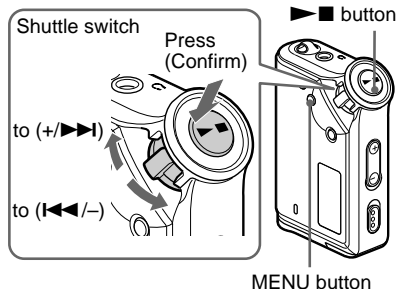

## 1 Press the MENU button.

The menu screen is displayed.

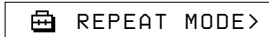

## 2 Rotate the Shuttle switch to select "FORMAT" and press the ▶■ button to confirm.



You cannot format memory while playing music.

## 3 Rotate the Shuttle switch to select "Y" and press the ▶■ button to confirm.

"Really?" is displayed.

## 4 Press the ▶■ button.

"FORMATTING" blinks and formatting starts.

When formatting is complete, "COMPLETE" is displayed and the display returns to the indication in step 2.

## 5 Press the MENU button.

The display returns to the normal screen.

### To cancel the menu mode

Select [RETURN] in the menu screen or press the MENU button.

### To cancel formatting

Select "N" in step 3.

### Note

You cannot format memory while playing music. ("FORMAT" will not be displayed in the menu screen.)

---

## Precautions

### **On installation**

Never use your Network Walkman where it will be subjected to extremes of light, temperature, moisture or vibration.

### **On the headphones**

#### ***Road Safety***

Do not use headphones while driving, cycling, or operating any motorized vehicle. It may create a traffic hazard and is illegal in many areas. It can also be potentially dangerous to play your Network Walkman at a high volume while walking, especially at pedestrian crossings. You should exercise extreme caution or discontinue use in potentially hazardous situations.

#### ***Preventing hearing damage***

Avoid using the headphones at a high volume. Hearing experts advise against continuous, loud and extended play. If you experience a ringing in your ears, reduce the volume or discontinue use.

#### ***Caring for others***

Keep the volume at a moderate level. This will allow you to hear outside sounds and to be considerate to the people around you.

#### ***Warning***

If there is lightning when you are using your Network Walkman, take off the headphones immediately.

### **On cleaning**

- Clean your Network Walkman casing with a soft cloth slightly moistened with water or a mild detergent solution.
- Clean the headphone plug periodically.

#### **Note**

Do not use any type of abrasive pad, scouring powder or solvent such as alcohol or benzene as it may mar the finish of the casing.

If you have any questions or problems concerning your Network Walkman, please consult your nearest Sony dealer.

# Troubleshooting

If you experience any of the following difficulties while using your Network Walkman, use this troubleshooting guide to help you to remedy the problem prior to consult a Sony dealer. Should any problem persist, consult your nearest Sony dealer. For trouble concerning operations while connected to your computer, please refer to “Troubleshooting” in the online help of the supplied software in addition.

## To reset the player

If your Network Walkman does not operate normally or if there is no sound, even after checking the troubleshooting guide below, remove the battery, then re-insert it.

## What happened?

### On operating

Symptom	Cause/Remedy
There is no sound. Noise is generated.	<ul style="list-style-type: none"><li>• The volume level is set to zero. → Turn the volume up (page 14).</li><li>• The headphone jack is not connected properly. → Connect the headphone jack properly (page 14).</li><li>• The headphone plug is dirty. → Clean the headphone plug with a soft dry cloth.</li><li>• Songs with a limited playing period is played. → Songs with an expired playing period cannot be played.</li><li>• No audio files are stored in the memory. → If “NO DATA” is displayed, transfer audio file(s) from the computer.</li></ul>
Buttons do not work.	<ul style="list-style-type: none"><li>• The HOLD switch is set to on. → Set the HOLD switch to off (page 24).</li><li>• Your Network Walkman contains moisture condensation. → Keep your Network Walkman aside for a few hours.</li><li>• The remaining battery power is insufficient. → Replace the battery (page 9).</li></ul>
The volume is not loud enough.	The AVLS is enabled. → Disable the AVLS (page 27).
There is no sound from the right channel of the headphones.	<ul style="list-style-type: none"><li>• The headphone jack is not fully connected. → Connect the headphone jack fully (page 14).</li></ul>
Playback has stopped suddenly.	The remaining battery power is insufficient. → Replace the battery (page 9).

## On the display window

Symptom	Cause/Remedy
The backlight is not turned on.	LIGHT is set to "OFF." → In the menu mode, set "LIGHT" to "ON" (page 31).
"□" is displayed for a title.	Characters that cannot be displayed on your Network Walkman are involved. → Use the supplied SonicStage software to rename the title with appropriate characters.

## On the connection with the computer or supplied software

Symptom	Cause/Remedy
The software cannot be installed.	An operating system not compatible with the software is used. → For details, refer to the separate manual "SonicStage operating instructions."
"CONNECT" is not displayed when connecting to the computer with the dedicated USB cable.	<ul style="list-style-type: none"> <li>• Please wait for the authentication of the SonicStage software.</li> <li>• Another application is running on the computer. → Wait for a while and reconnect the USB cable. If the problem persists, disconnect the USB cable, restart the computer, and then reconnect the USB cable.</li> <li>• The dedicated USB cable is disconnected. → Connect the dedicated USB cable.</li> <li>• A USB hub is used. → Connecting via a USB hub is not guaranteed. Connect the dedicated USB cable directly to the computer.</li> </ul>
Your Network Walkman is not recognized by the computer when it is connected to the computer.	The dedicated USB cable is disconnected. → Connect the dedicated USB cable.
Song cannot be transferred to your Network Walkman.	<ul style="list-style-type: none"> <li>• The dedicated USB cable is not connected properly. → Connect the USB cable properly.</li> <li>• The free space of the built-in flash memory to where you want to transfer audio files to is insufficient. → Transfer any unnecessary songs back to your computer to increase free space.</li> <li>• You have already transferred to 400 songs or 400 groups to the built-in flash memory using the SonicStage software. → The maximum number of songs or groups that you can transfer to the built-in flash memory using the SonicStage software is 400.</li> <li>• Audio files with a limited playing period or playing count may not be transferred due to restrictions set by copyright holders. For details on the settings of each audio file, contact the distributor.</li> </ul>

<b>Symptom</b>	<b>Cause/Remedy</b>
The number of audio files that can be transferred to is limited. (Available recording time is short.)	<ul style="list-style-type: none"> <li>• The free space of the built-in flash memory to where you want to transfer to is not enough for the size of audio files you wish to transfer.               <ul style="list-style-type: none"> <li>→ Transfer any unnecessary audio files back to the computer to increase free space.</li> </ul> </li> <li>• Non-audio data is stored in the built-in flash memory to where you want to transfer audio files to.               <ul style="list-style-type: none"> <li>→ Move non-audio data to the computer to increase free space.</li> </ul> </li> </ul>
The operation of the Network Walkman becomes unstable while it is connected to the computer.	<p>USB hub or USB extension cable is used.</p> <ul style="list-style-type: none"> <li>→ Connecting via a USB hub or USB extension is not guaranteed. Connect the dedicated USB cable directly to the computer.</li> </ul>
“Failed to authenticate Device/Media” is displayed on the computer screen while connecting the Network Walkman to the computer.	<p>Your Network Walkman is not connected to the computer properly.</p> <ul style="list-style-type: none"> <li>→ Quit the SonicStage software and verify the connection of the dedicated USB cable. Restart the SonicStage software.</li> </ul>
<b>Other</b>	
<b>Symptom</b>	<b>Cause/Remedy</b>
There is no beep sound when your Network Walkman is operated.	<p>BEEP is set to “OFF.”</p> <ul style="list-style-type: none"> <li>→ In the menu mode, set “BEEP” to “ON” (page 30).</li> </ul>
Your Network Walkman gets warm.	Sometimes, during normal conditions, the player becomes slightly warm.

continued

## Messages

Follow the instructions below if an error message appears in the display.

<b>Message</b>	<b>Meaning</b>	<b>Remedy</b>
ACCESS	Accessing the built-in flash memory.	Please wait for access to complete. This message appears while transferring audio files and during initialization of the built-in flash memory.
AVLS	The volume level exceeds the rated value while the AVLS is enabled.	Turn the volume down or disable the AVLS.
CANNOT PLAY	<ul style="list-style-type: none"> <li>Your Network Walkman cannot play certain files because of incompatible formats.</li> <li>Transferring has been interrupted forcefully.</li> </ul>	If the file cannot be played, you can erase it from the built-in flash memory. For details, refer to “To delete abnormal data from the built-in flash memory” (page 39).
CONNECT	Your Network Walkman is connected to the computer.	You can operate your Network Walkman using the SonicStage software, but you cannot operate the controls on your Network Walkman.
ERROR	A malfunction is detected.	Please consult your nearest Sony dealer.
EXPIRED	<ul style="list-style-type: none"> <li>The song with a playback restriction has expired.</li> <li>The current time has not been set to play the song with a playback restriction.</li> <li>The song is protected by the playback restriction that is not compatible with your Network Walkman.</li> </ul>	<ul style="list-style-type: none"> <li>If the current time has not been set yet, set the current time in the menu mode (page 26).</li> <li>If song cannot be played, you can erase it from the built-in flash memory. For details, refer to “To delete abnormal data from the built-in flash memory (page 39).</li> <li>Your Network Walkman does not support contents with a limited playing count. For details, refer to “Note on playing songs with a limited playing count” (page 13).</li> </ul>
FILE ERROR	<ul style="list-style-type: none"> <li>The file cannot be read.</li> <li>The file is not normal.</li> </ul>	Transfer the normal audio file back to the computer and then format your Network Walkman. (For details, refer to “To delete abnormal data from the built-in flash memory” on page 39.)
HOLD	All operation buttons are disabled since the HOLD switch is set to on.	Set the HOLD switch to off to operate the buttons.
LOW BATT	The battery is low.	You must change the battery (page 9).
MEMORY FULL	The memory is full or there are 400 groups.	Delete songs or groups. A group without song is also regarded as one group. To delete groups without song, use the SonicStage software.

Message	Meaning	Remedy
MG ERROR	An unauthorized distribution file is detected for copyright protection.	Transfer normal audio files back to the computer and then format the built-in flash memory of your Network Walkman. (For details, refer to “To delete abnormal data from the built-in flash memory” on page 39.)
NO AUDIO	There is no audio files in the built-in flash memory.	If there is no audio files in the built-in flash memory, use the SonicStage software to transfer audio files.

### To delete abnormal data from the built-in flash memory

If “CANNOT PLAY,” “EXPIRED,” or “FILE ERROR” is displayed, there is a problem with all or part of the data stored in the built-in flash memory.

Please follow the procedures below to erase data you cannot play.

- 1 Connect your Network Walkman to the computer, and start the SonicStage software.
- 2 If you have already specified the data with problems (such as expired songs), erase the data from the Portable Player window of the SonicStage software.
- 3 If the problem persists, click the  button on the SonicStage software to transfer all data without problems while your Network Walkman is connected to the computer.
- 4 Disconnect your Network Walkman from the computer and then format the built-in flash memory using the FORMAT menu (page 33).

---

# Specifications

## Maximum recording time (Approx.)

---

### ATRAC3

4 hr. 10 min. (132 kbps)

5 hr. 10 min. (105 kbps)

8 hr. 20 min. (66 kbps)

---

### ATRAC3plus

2 hr. 00 min. (256 kbps)

8 hr. 30 min. (64 kbps)

11 hr. 40 min. (48 kbps)

## Sampling frequency

ATRAC3, ATRAC3plus: 44.1 kHz

## Audio compression technology

Adaptive Transform Acoustic Coding3 (ATRAC3)

Adaptive Transform Acoustic Coding3plus  
(ATRAC3plus)

## Frequency response

20 to 20,000 Hz (single signal measurement)

## Output

Headphone: Stereo mini-jack

## Signal-to-noise ratio (S/N)

80 dB or more (excluding ATRAC3 66 kbps)

## Dynamic range

85 dB or more (excluding ATRAC3 66 kbps)

## Operating temperature

5°C to 35°C (67°F to 95°F)

## Power source

Size AAA (LR03) alkaline battery

## Battery life (continuous playback)

ATRAC3 format: Approximately 70 hours

ATRAC3plus format: Approximately 60 hours

## Dimension

56 × 37.3 × 15 mm (2 1/4 × 1 1/2 × 19/32 inches)  
(w/h/d, projecting parts not included)

## Mass

Approx. 40 g (2 oz) (battery not included)

## Supplied accessories

Headphones (1)

Dedicated USB cable (1)

CD-ROM (1)

Operating Instructions (1)

SonicStage operating instructions (1)

Design and specifications are subject to change without notice.



---

# Glossary

## MagicGate

Copyright protection technology that consists of authentication and encryption technology. Authentication ensures that protected content is transferred only between compliant devices and media, and that protected content is recorded and transferred in an encrypted format to prevent unauthorized copying or playback.

### Note

**MAGICGATE** is terminology denoting the copyright protection system developed by Sony. It does not guarantee conversion among other media.

## OpenMG

Copyright protection technology that securely manages music content from the EMD/Audio CD on a personal computer. Application software that is installed on the computer encrypts the digital music content when recording on the hard drive. This allows you to enjoy music content on the computer, but prevents unauthorized transmission of this content across a network (or elsewhere). This PC copyright protection complies with “MagicGate”, and allows you to transfer digital music content from a PC’s hard drive to a compliant device.

## SonicStage

Copyright protection technology that securely manages music content from the EMD/Audio CD on a personal computer. Application software that is installed on the computer encrypts the digital music content when recording on the hard drive. This allows you to enjoy music content on the computer, but prevents unauthorized transmission of this content across a network (or elsewhere). This PC copyright protection complies with “MagicGate”, and allows you to transfer digital music content from a computer’s hard disk to a compliant device.

## ATRAC3

ATRAC3, which stands for Adaptive Transform Acoustic Coding3, is audio compression technology that satisfies the demand for high sound quality and high compression rates. The ATRAC3 compression rate is approximately 10 times higher than that of the Audio CD, resulting in an increased data capacity for the media.

## ATRAC3plus

ATRAC3plus, which stands for Adaptive Transform Acoustic Coding3plus, is audio compression technology that compresses data higher than ATRAC3. The ATRAC3plus is new audio compression technology that enables equal or higher quality sound comparing to ATRAC3.

### **Bit rate**

Indicates the data amount per second. The rate is reflected in bps (bit per second).

64 kbps means 64000 bits of information per second. If the bit rate is large, that means a large amount of information is used to play music. Comparing music of the same format (e.g., ATRAC3plus), 64 kbps data offers better sound quality than 48 kbps data. However, audio files in formats such as MP3 have different encoding methods, and thus sound quality cannot be determined by simply comparing the bit rate.

# Menu list

**Press the MENU button to display the menu mode and use the Shuttle switch (rotate: select/press: confirm) to change the settings of your Network Walkman.**

For details about each menu, refer to the pages in parentheses. The menu with a ">" mark will be followed by a detailed-setting screen when you press the Shuttle switch to confirm.

Display (Menu mode)	Purposes
<b>REPEAT MODE &gt;</b>	You can select your favorite repeat mode. (page 17)
<b>DISPLAY &gt;</b> (Display mode)	You can select your favorite display mode. (page 21)
<b>VOL:</b> (Preset volume)	You can preset your desired volume level. (page 28)
<b>SOUND &gt;</b> (Digital sounds preset)	You can preset your desired sound quality. (page 22)
<b>AVLS:</b> (Automatic Volume Limiter System)	You can set to "ON" or "OFF." (page 27)
<b>BEEP:</b> (Operation sounds setting)	You can set to "ON" or "OFF." (page 30)
<b>LIGHT:</b> (LCD backlight setting)	"OFF": Always off "ON": Turns on for three seconds after each operation (page 31)
<b>DATE-TIME</b> (Current time setting)	You can set and display the current time. (page 26)
<b>PC CLK:</b> (Adjusting the time setting to a computer built-in clock)	You can adjust the time setting of your Network Walkman to a computer built-in clock. (page 25)

Display (Menu mode)	Purposes
<b>FORMAT &gt;</b> (Formatting memory)	You can format the built-in flash memory. (page 33)
<b>REGROUP &gt;</b> (Regrouping data)	You can restore the group function. (page 32)
<b>[RETURN]</b>	You can switch to the normal mode by selecting [RETURN] and pressing the  button.

---

# Index

## A

A-B Repeat	18
ACCESS lamp	12
Accessories	8
ATRAC3	41
ATRAC3plus	41
Audio CDs	6
AVLS (Limiting the volume)	11, 27

## B

Backlight	31
Battery	7, 9
BEEP (Beep sound)	30
Bit rate	42

## C

CD (Audio CDs)	6
CD-ROM	8, 12
Clock	25, 26
Computer	6, 12

## D

DATE-TIME	26
Display	11, 18, 38
Display mode	21
Download	6

## E

EMD service	6, 13
Explorer (Windows Explorer)	13, 24

## F

Fast-forward	16
Fast-rewind	16
FORMAT	33
Formatting	33

## G

Group	15, 22
-------	--------

## H

Headphones	8, 14, 34
HOLD	24
HOLD function (Locking the controls)	24

## L

LIGHT	31
Limiting the volume (AVLS)	27
Listening	14
Locking the controls (HOLD function)	24

## M

MENU button	17, 19-21, 23, 25-33
Menu list	43
MP3	6

## O

OpenMG	41
--------	----

## P

PC CLK	25
Playback	14

**R**

Regroup	32
Remaining battery indication	9
Repeat	17
Repeat count	20
Reset	35
RETURN	43

**S**

Sentence Repeat	19
Serial Number	8
Shuffle Repeat	17
Shuttle switch	16-21, 23, 25-33
Skip to the beginning of a track	16
SonicStage	41
Sound preset (Digital Sound Preset)	22

**T**

Time setting	25, 26
Title	21
Track Repeat	18
Transferring	6, 12
Troubleshooting	35

**U**

USB cable	8, 12
-----------	-------

**V**

Volume	28
--------	----

**W**

WAV format	6
Windows Explorer	13, 24





This warranty is valid only in the United States.

**SONY**<sup>®</sup>

Portable Memory Stick Audio Player/  
Portable MiniDisc Recorder/  
Portable CD Player/  
Portable IC Audio Player/  
Portable Hard Disk Audio Player

Portable Audio

## LIMITED WARRANTY

Sony Electronics Inc. ("Sony") warrants this Product (including any accessories) against defects in material or workmanship as follows:

1. **LABOR:** For a period of 90 days from the date of purchase, if this Product is determined to be defective, Sony will repair or replace the Product, at its option, at no charge, or pay the labor charges to any Sony authorized service facility. After the Warranty Period, you must pay for all labor charges.

2. **PARTS:** In addition, Sony will supply, at no charge, new or rebuilt replacements in exchange for defective parts for a period of one (1) year. After 90 days from the date of purchase, labor for removal and installation is available from Sony authorized service facilities or a Sony Service Center at your expense.

To obtain warranty service, you must take the Product, or deliver the Product freight prepaid, in either its original packaging or packaging affording an equal degree of protection, to any authorized Sony service facility.

This warranty does not cover customer instruction, installation, set up adjustments or signal reception problems.

This warranty does not cover cosmetic damage or damage due to acts of God, accident, misuse, abuse, negligence, commercial use, or modification of, or to any part of the Product, including the antenna. This warranty does not cover damage due to improper operation or maintenance, connection to improper voltage supply, or attempted repair by anyone other than a facility authorized by Sony to service the Product. This warranty does not cover Products sold AS IS or WITH ALL FAULTS, or consumables (such as fuses or batteries). This warranty is valid only in the United States.

Proof of purchase in the form of a bill of sale or receipted invoice which is evidence that the unit is within the Warranty period must be presented to obtain warranty service.

This warranty is invalid if the factory applied serial number has been altered or removed from the Product.

REPAIR OR REPLACEMENT AS PROVIDED UNDER THIS WARRANTY IS THE EXCLUSIVE REMEDY OF THE CONSUMER. SONY SHALL NOT BE LIABLE FOR ANY INCIDENTAL OR CONSEQUENTIAL DAMAGES FOR BREACH OF ANY EXPRESS OR IMPLIED WARRANTY ON THIS PRODUCT. EXCEPT TO THE EXTENT PROHIBITED BY APPLICABLE LAW, ANY IMPLIED WARRANTY OF MERCHANTABILITY OR FITNESS FOR A PARTICULAR PURPOSE ON THIS PRODUCT IS LIMITED IN DURATION TO THE DURATION OF THIS WARRANTY.

Some states do not allow the exclusion or limitation of incidental or consequential damages, or allow limitations on how long an implied warranty lasts, so the above limitations or exclusions may not apply to you. In addition, if you enter into a service contract with the Sony Partnership within 90 days of the date of sale, the limitation on how long an implied warranty lasts does not apply to you. This warranty gives you specific legal rights, and you may have other rights which vary from state to state.

For your convenience, Sony Electronics Inc. has established telephone numbers for frequently asked questions:

To locate the servicer or dealer nearest you, or for service assistance or resolution of a service problem, or for product information or operation, contact:

[www.sony.com/walkmansupport](http://www.sony.com/walkmansupport)

**Sony Network Portable Audio Support Line**  
**1-866-456-7669**

For an accessory or part not available from your authorized dealer, call:

1-800-488-SONY (7669)

D 324343304

<http://www.sony.net/>

Printed in China