

Compact Disc Player

Operating Instructions



CDP-CX240
CDP-CX220

WARNING

To prevent fire or shock hazard, do not expose the unit to rain or moisture.

To avoid electrical shock, do not open the cabinet. Refer servicing to qualified personnel only. Do not install the appliance in a confined space, such as a bookcase or built-in cabinet.

For the customers in the United States

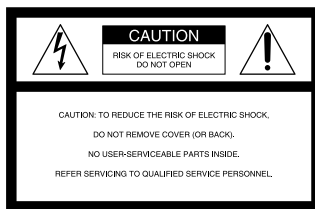

This symbol is intended to alert the user to the presence of uninsulated "dangerous voltage" within the product's enclosure that may be of sufficient magnitude to constitute a risk of electric shock to persons.



This symbol is intended to alert the user to the presence of important operating and maintenance (servicing) instructions in the literature accompanying the appliance.

INFORMATION

This equipment has been tested and found to comply with the limits for a Class B digital device, pursuant to Part 15 of the FCC Rules. These limits are designed to provide reasonable protection against harmful interference in a residential installation. This equipment generates, uses, and can radiate radio frequency energy and, if not installed and used in accordance with the instructions, may cause harmful interference to radio communications.

However, there is no guarantee that interference will not occur in a particular installation. If this equipment does cause harmful interference to radio or television reception, which can be determined by turning the equipment off and on, the user is encouraged to try to correct the interference by one or more of the following measures:

- Reorient or relocate the receiving antenna.
- Increase the separation between the equipment and receiver.
- Connect the equipment into an outlet on a circuit different from that to which the receiver is connected.
- Consult the dealer or an experienced radio/TV technician for help.

CAUTION

You are cautioned that any changes or modification not expressly approved in this manual could void your authority to operate this equipment.

Owner's Record

The model and serial numbers are located at the rear of the unit. Record the serial number in the space provided below. Refer to them whenever you call upon your Sony dealer regarding this product.

Model No. CDP-CX240/CDP-CX220
Serial No. _____

(Except for the customers in the United States)

The following caution label is located inside the unit.



This appliance is classified as a CLASS 1 LASER product.

The CLASS 1 LASER PRODUCT MARKING is located on the rear exterior.

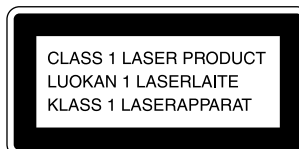

This equipment is intended for home entertainment purposes only. The warranty shall be invalidated if used in commercial environments, such as by disc jockeys, etc., even within the Warranty Period.

Welcome!

Thank you for purchasing the Sony Compact Disc Player. Before operating the unit, please read this manual thoroughly and retain it for future reference.

About This Manual

The instructions in this manual are for models CDP-CX240 and CDP-CX220. The CDP-CX240 is the model used for illustration purposes. Any difference in operation is clearly indicated in the text, for example, "CDP-CX240 only."

Conventions

- Instructions in this manual describe the controls on the player. You can also use the controls on the remote if they have the same or similar names as those on the player.
- The following icons are used in this manual:



Indicates that you can do the task using the remote.



Indicates hints and tips for making the task easier.

TABLE OF CONTENTS

Getting Started

Unpacking	4
Hooking Up the System	4
Connecting Another CD Player (CDP-CX240 only)	6
Inserting CDs	7

Playing a CD	10
--------------------	----

Playing CDs

Using the Display	12
Locating a Specific Disc	13
Specifying the Next Disc to Play	15
Locating a Specific Track or a Point in a Track	15
Playing Repeatedly	16
Playing in Random Order (Shuffle Play)	16
Creating Your Own Program (Program Play)	17
Playing Using a Timer (CDP-CX240 only)	19
Controlling Another CD Player (Advanced Mega Control) (CDP-CX240 only)	20
Fading In or Out (CDP-CX240 only)	21
Playing Alternately (No-Delay Play/X-Fade Play) (CDP-CX240 only)	22

Storing Information About CDs (Custom Files)

What You Can Do With the Custom Files	23
Labeling Discs (Disc Memo)	23
Storing Custom File Information Using a keyboard (CDP-CX240 only)	26
Storing Specific Tracks (Delete Bank)	26
Grouping Discs (Group File)	27
Storing Your Favorite Tracks (Hit List) (CDP-CX240 only)	28

Additional Information

Precautions	30
Notes on CDs	30
Troubleshooting	31
Specifications	31

Index	Back cover
-------------	------------

Unpacking

Check that you received the following items:

- Audio cord (1)
- Remote commander (remote) (1)
- Sony SUM-3 (NS) batteries (2)
- CD booklet holders (2) and label (1)

💡 How to use the CD booklet holder

The CD booklet holder helps you locate the disc easily. After you have inserted discs into the player, you can put the CD booklet (which comes with a CD) into the supplied holder. Put two CD booklets facing back to back into a pocket. Stick the number label on each pocket, matching the number of the disc slot where you have inserted the disc. You can put up to 200 CD booklets into the holders.

Inserting batteries into the remote

You can control the player using the supplied remote. Insert two size AA (R6) batteries by matching the + and - on the batteries to the diagram inside the battery compartment. Insert the negative (-) end first, then push in and down until the positive (+) end clicks into position. When using the remote, point it at the remote sensor  on the player.

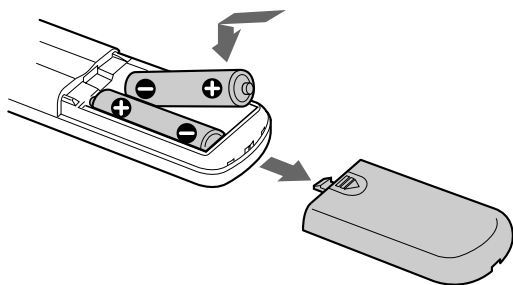

💡 When to replace batteries

With normal use, the batteries should last for about six months. When the remote no longer operates the player, replace all the batteries with new ones.

Notes

- Do not leave the remote near an extremely hot or humid place.
- Do not drop any foreign object into the remote casing, particularly when replacing the batteries.
- Do not expose the remote sensor to direct sunlight or lighting apparatuses. Doing so may cause a malfunction.
- If you do not use the remote for an extended period of time, remove the batteries to avoid possible damage from battery leakage and corrosion.

Hooking Up the System

Overview

This section describes how to hook up the CD player to an amplifier. Be sure to turn off the power of each component before making the connections.

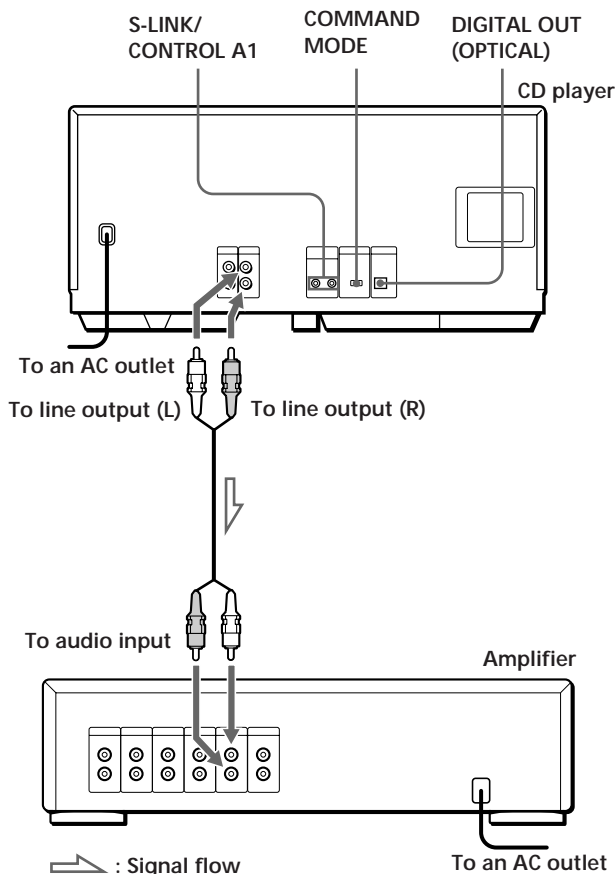

What cords will I need?

Audio cord (1) (supplied)

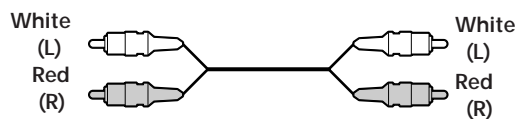

Hookups

When connecting the audio cord, be sure to match the color-coded cord to the appropriate jacks on the components: Red (right) to Red and White (left) to White. Be sure to make connections firmly to avoid hum and noise.

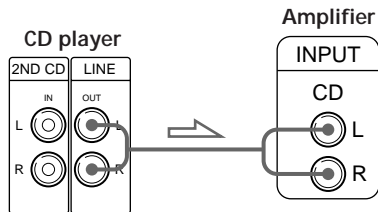

- If you have a digital component such as a digital amplifier, D/A converter, DAT or MD
Connect the component via the DIGITAL OUT (OPTICAL) connector using an optical cable (not supplied). Take off the cap and plug in the optical cable.

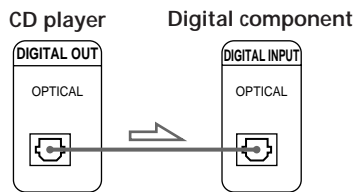
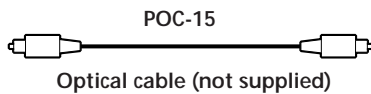

Note

When you connect via the DIGITAL OUT (OPTICAL) connector, noise may occur when you play CD software other than music, such as a CD-ROM.

- If you have a Sony component with the CONTROL A1 jack

Connect the component via the CONTROL A1 jack. You can simplify the operation of audio systems composed of separate Sony components. For details, refer to the supplementary "S-Link™/CONTROL-A1 Control System" instructions.

- When using another Sony CD player together with this player

You can make the supplied remote effective only for this player.

- When using the player equipped with the COMMAND MODE selector:
Set the COMMAND MODE selector of this player to CD 1 and that of another player to CD 2 or CD 3. Then set the CD 1/2/3 switch on the remote supplied for each player accordingly.
- When using the player not equipped with the COMMAND MODE selector:
The command mode of the player without the COMMAND MODE selector is set to CD 1. Set the COMMAND MODE selector of this player to CD 2, and set the CD 1/2/3 switch on the remote to CD 2.

Setting the voltage selector (voltage selector equipped models only)

Check that the voltage selector on the rear panel of the player is set to the local power line voltage. If not, set the selector to the correct position using a screwdriver before connecting the AC power cord to a wall outlet.

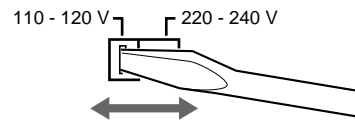

Connecting the AC power cord

Connect the AC power cord to a wall outlet.

Note on placement

Be sure to place the player on a horizontal place. If the player is slanted, it may cause malfunction or damage the player.

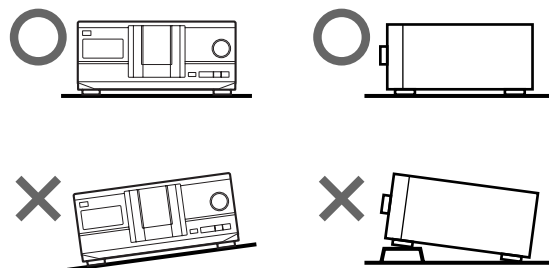

Connecting Another CD Player (CDP-CX240 only)

If you have a Sony CD player equipped with the CONTROL A1 jack and the command mode of that player can be set to CD 3, you can control that player as the second player with this unit. After connecting this unit and an amplifier, follow the procedure below. Be sure to turn off the power of each player before making this connection.

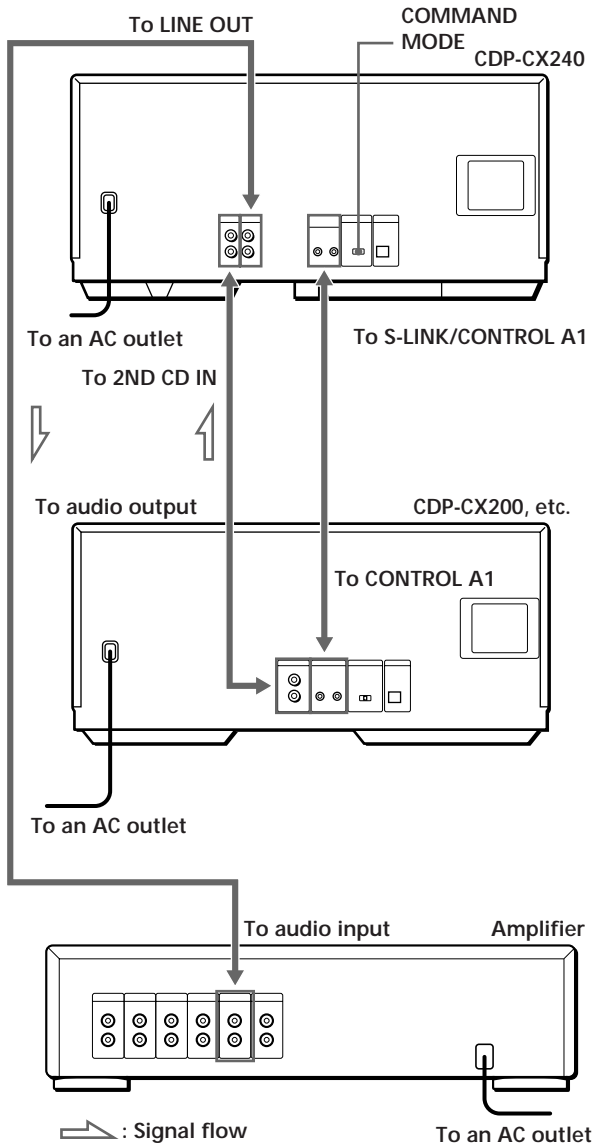

What cords will I need?

- Audio cord (1) (Use the cord supplied with the player to be connected.)
- Monaural (2P) mini-plug cord (1) (not supplied)

- 1 Connect the players with an audio cord (see also "Hookups" on page 5).

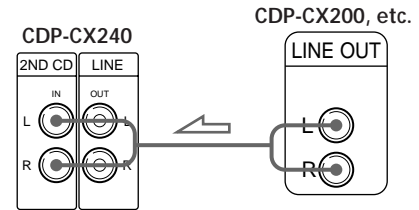

- 2 Connect the players with a monaural (2P) mini-plug cord.

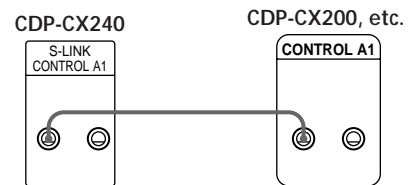

For details on this connection, refer to the supplementary "S-Link™/CONTROL-A1 Control System" instructions.

- 3 Set the COMMAND MODE selector of each player. Set the COMMAND MODE selector of this player to CD 1 or CD 2, and set that of the second player to CD 3.

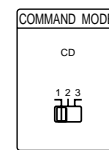

For details on how to operate the second player, see "Controlling Another CD Player" on page 20 and "Playing Alternately" on page 22.

- 4 Connect the AC power cord of both players to AC outlets.

Notes

- Do not connect a player other than that you use as the second player to the 2ND CD IN jacks of this player.
- When connecting a second CD player, do not connect the DIGITAL OUT (OPTICAL) connector of this unit to the amplifier.

Inserting CDs

You can insert up to 200 discs into this player.

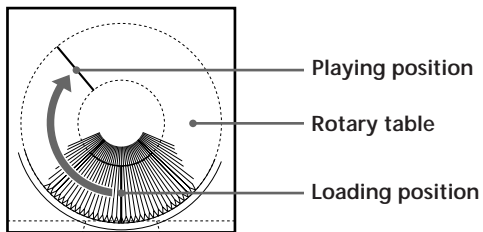
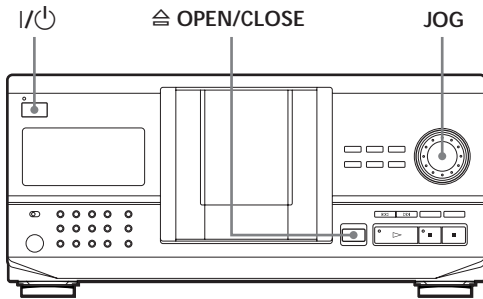

- 1 Press I/⏻ to turn on the player.
- 2 Open the front cover by pressing OPEN/CLOSE.

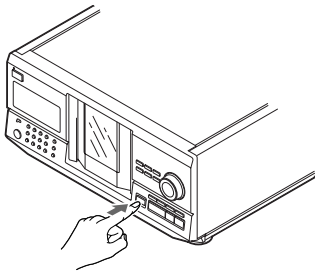

- 3 Turn the JOG dial until you find the disc slot where you want to insert a disc, while checking the disc number (written beside every slot and also indicated in the display).

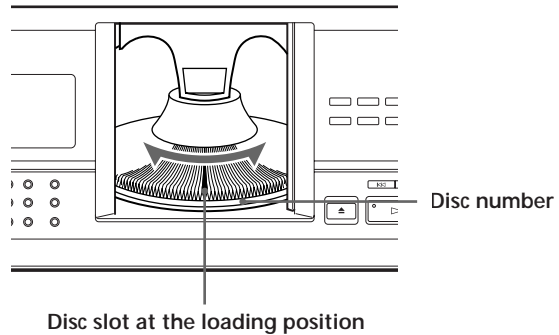

The disc number at the loading position appears in the display.* If the disc has the Disc Memo (see page 23), the Disc Memo appears instead of the disc number. As you turn the JOG dial, the disc number or the Disc Memo changes.

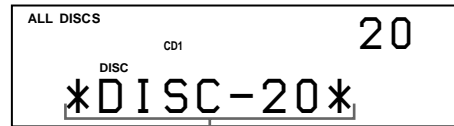

Disc number or the Disc Memo

You can classify discs into eight groups by using the Group File function. This feature lets you easily find the disc you want to play. For details, see "Grouping Discs" on page 27.

* If you have already inserted discs, the disc number at the playing position appears. When you turn the JOG dial, the displayed disc number changes to the one at the loading position.

(Continued)

- 4 Insert a disc with the label side facing right.

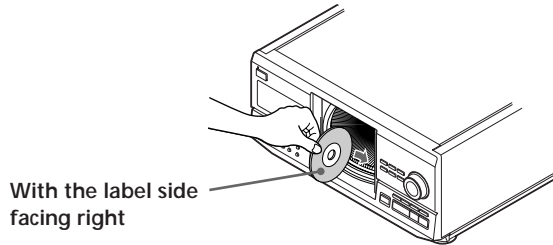

After inserting the disc, you can input the original disc titles instead of the disc numbers (see “Labeling Discs” on page 23) to locate it easily when you start playing.



- 5 Repeat Steps 3 and 4 to insert more discs.
- 6 Close the front cover by pressing  OPEN/CLOSE.

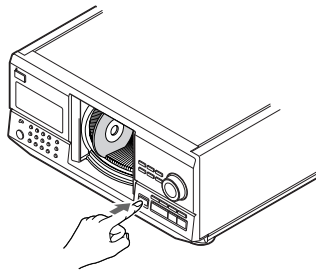



The rotary table turns and the disc slot at the loading position is set to the playing position. Always close the front cover except when you insert or remove discs.

-  The supplied CD booklet holders help you locate a disc

You can store up to 200 CD booklets. Insert a booklet and stick the number label on the film of a pocket and the booklet so that you can locate the disc easily.

Notes

- Do not insert an empty 8 cm (3-inch) CD adaptor (CSA-8). It may damage the player.
- Do not attach anything such as seals or sleeves to CDs. It may damage the player or the disc.
- If you drop a disc into the player and the CD won't go into the slot correctly, consult your nearest Sony dealer.
- When transporting the player, remove all discs from the player.
- Make sure you have inserted the disc into each slot at a right angle to the rotary table. If the disc is not put in straight, it may damage the player or the disc.
- Make sure the rotary table comes to a complete stop before inserting or removing discs.

The front panel closes automatically when you press . Be careful not to put your hand into the player after pressing  otherwise your hand may be caught in the front panel.

Removing CDs

After following Steps 1 to 3 of “Inserting CDs” on page 7, remove the discs. Then close the front cover.

Playing a CD

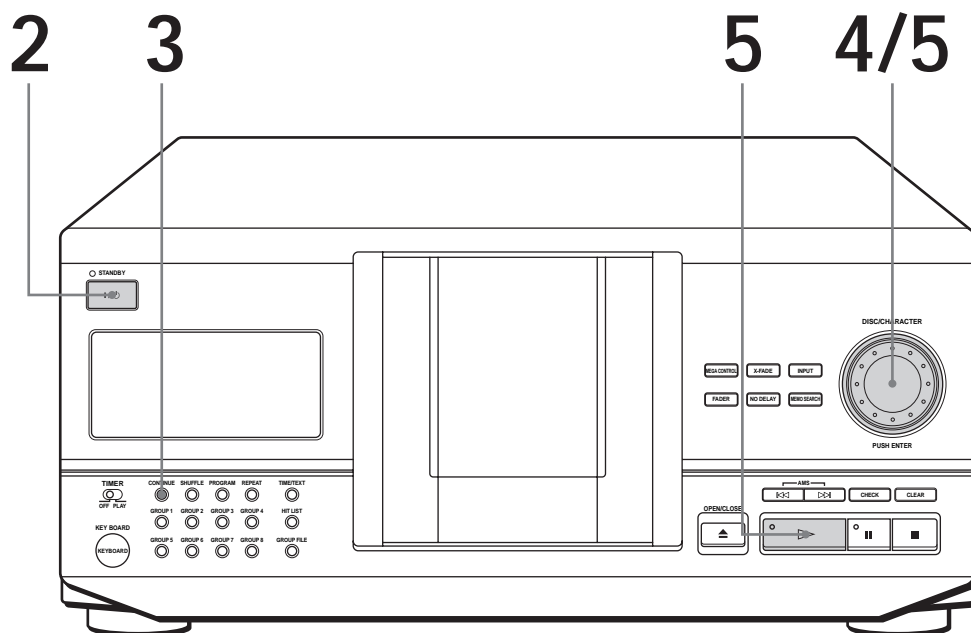

- See pages 4 – 5 for the hookup information.
- Make sure you have inserted the discs correctly as indicated on pages 7 – 8.
- You can play all the tracks on a disc in the original order (Continuous Play). You can also play up to 200 discs consecutively.

You can turn on the player by pressing on the remote .

- 1 Turn on the amplifier and select the CD player position.
- 2 Press to turn on the player.
- 3 Press CONTINUE to select ALL DISCS or 1 DISC Continuous Play mode.
Each time you press CONTINUE, “ALL DISCS” or “1 DISC” appears in the display.

When you select	The player plays
ALL DISCS	All discs in the player consecutively in the order of disc number. Empty disc slots are skipped.
1 DISC	Only one disc you have selected

- 4 Turn the JOG dial until the disc number or the Disc Memo (see page 23) you want appears in the display to select the first disc (ALL DISCS) or the disc you want (1 DISC).

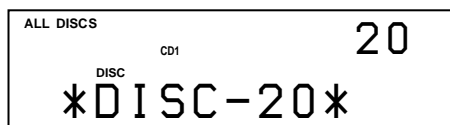







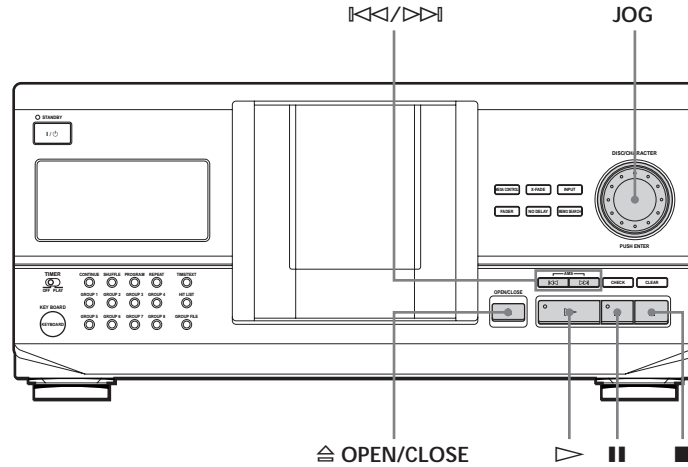

 When you turn off the player
The player remembers the last playing disc and the play mode (Continuous, Shuffle (see page 16) or Program (see page 17)). When you turn on the player again, therefore, the player plays the same disc in the same play mode.

- 5** Push the JOG dial or press  to start playing.
The selected disc is set to the playing position, and the player plays all the discs from the selected one (ALL DISCS) or all the tracks once (1 DISC).
Adjust the volume on the amplifier.

To stop playback

Press .



To	You need to
Pause	Press 
Resume playing after pause	Press  or 
Go to the next disc 	Press DISC SKIP + once. Hold down the button to skip discs.
Go back to the preceding disc 	Press DISC SKIP - once. Hold down the button to skip discs.
Go to the next track	Press 
Go back to the preceding track	Press 
Stop playing and remove the disc	Press 

Using the Display

You can check information about the disc using the display.

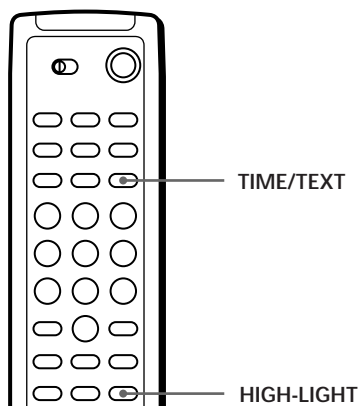
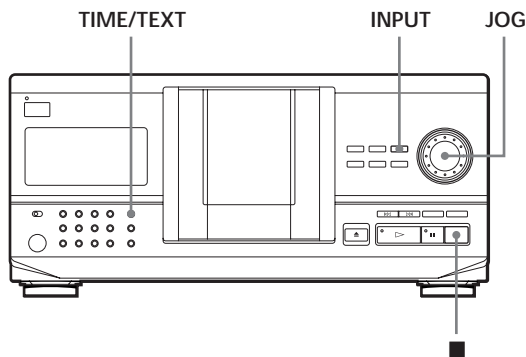

Checking the total number and playing time of the tracks

Select the disc you want to check, and push the JOG dial in the Continuous Play mode. As the player starts play automatically, press ■ to stop, and then TIME/TEXT.

The display shows the current disc number, total number of tracks and total playing time of the disc.

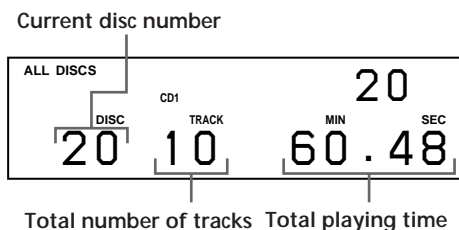

When you want to check another disc Press DISC SKIP on the remote in the stop mode to select the disc you want to check. The total number of tracks and the total playing time of the selected disc appear for a while.

Display information while playing a disc

While playing a disc, the display shows the current disc number, track number, playing time of the track and the next disc number.

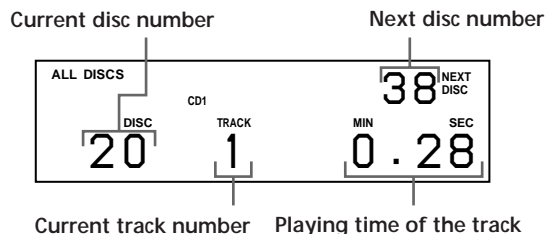

Checking the information of CD TEXT discs

CD TEXT discs have information, such as the disc titles or artist names, memorised in a blank space on the discs where, on normal discs, there is no information. The display shows the CD TEXT information of the disc so that you can check the current disc title, artist name and track title. When the player detects CD TEXT discs, the “CD TEXT” indication appears in the display. If your CD TEXT disc has multi language capacity, “MULTI CD TEXT” indication appears in the display. If you want to check the information in another language, refer to “Selecting the language of the CD TEXT information” on page 13.

Display information before you start playing

The display shows the disc title. When you press TIME/TEXT, the artist name scrolls in the display. If you press TIME/TEXT again, the display shows the current disc number, total number of tracks and total playing time of the disc momentarily. Then the display shows the disc title again.



Display information while playing a disc

Each time you press TIME/TEXT, the display shows the information as shown below.

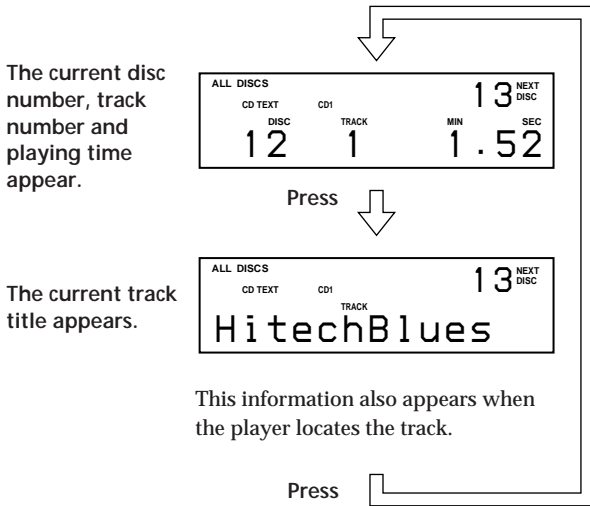

To play disc highlights

Some CD TEXT discs have a feature to play only the highlights of the discs.

Press HIGH-LIGHT on the remote to start playing disc highlights in the stop mode.

“Hi LIGHT” indication in the display flashes while playing disc highlights.

If you press HIGH-LIGHT while selecting discs without this feature, “NO HIGHLIGHT” appears in the display.

Selecting the language of the CD TEXT information

You can select the language used to display the CD TEXT information when you select a CD TEXT disc with multi-language information.

Once you select the language, the display shows the information in the selected language until you turn off the player. If the player cannot read the language memorized in a CD TEXT disc, the player shows “(other lang.).”

- 1 Press INPUT in stop mode. “Select lang.” flashes.

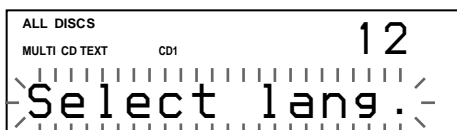

- 2 Push the JOG dial. The current operating language flashes.

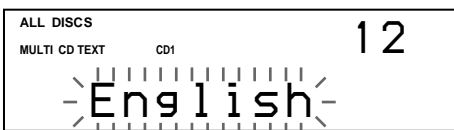

- 3 Turn the JOG dial until the language you want appears in the display.
- 4 Push the JOG dial to select the language. “Reading Text” appears momentarily, then the display shows the information in the selected language.

To check the current language

- 1 Press INPUT while playing a CD TEXT disc. “Show lang.” flashes.
- 2 Push the JOG dial.

The current language appears momentarily. You can also check the current language while selecting a CD TEXT disc without multi-language information.

Note

If you select a CD TEXT disc which does not contain the information of the selected language, the display shows the information in another language according to the disc’s priority.

Locating a Specific Disc

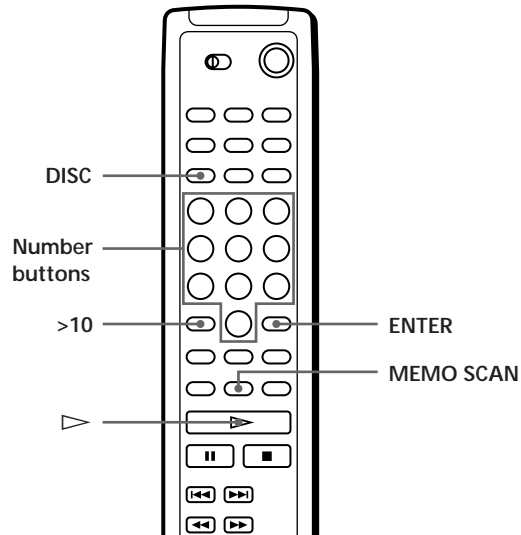
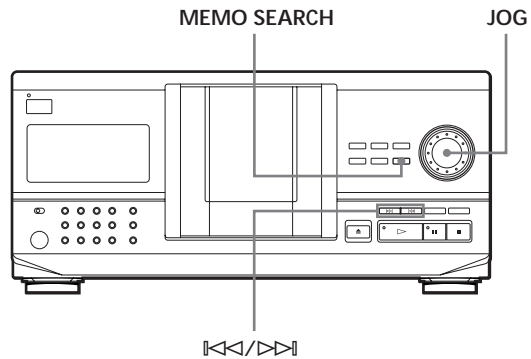

(Continued)

Selecting a disc on the player

Turn the JOG dial until the disc number or Disc Memo (see page 23) you want appears in the display. Push the JOG dial to start play.

Selecting a disc directly using the remote

- 1 Press DISC.
- 2 Press the number button of the disc.
Example: To enter number 35
Press 3 then 5.
To enter number 100
Press 1, then 10/0 twice.
- 3 Press ENTER to start play.

Locating a disc by scanning each Disc Memo (Memo Scan)

You can locate a disc you want to play quickly by scanning the Disc Memos (see page 23) in the display. Note that you cannot use this function in the ALL DISCS Shuffle Play mode.

- 1 Press MEMO SCAN.
“MEMO SCAN” appears in the display, and the Disc Memos scroll in the display.
- 2 Press \triangleright when the Disc Memo of the disc you want to play appears.
The disc is set to the playing position, and the player starts playing.

In Program Play mode, the disc will be added to the end of the program if you press ENTER instead of \triangleright .

Note

If “NO ENTRY” appears in the display, no disc has been labeled with the Disc Memo. Try the Memo Scan function again after labeling the discs.

Locating a disc by searching a specific Disc Memo (Memo Search)

You can search and locate a disc you want by inputting the first character used in the Disc Memo (see page 23).

- 1 Press MEMO SEARCH.
“MEMO SEARCH” appears in the display.
- 2 Press \llcorner/\triangleright repeatedly to input the first character.



Each time you press \llcorner/\triangleright , the characters appear in the following order.

A B C D E F G H I J K L M N O P Q R S T U V W X
Y Z 0 1 2 3 4 5 6 7 8 9

If “NOT FOUND” appears in the display while inputting the first character with the \llcorner/\triangleright buttons, no disc has been labeled using the input character.

Notes

- When searching input characters, blanks and symbols before the first character in the Disc Memo are ignored.
- When searching input characters, upper and lower cases cannot be differentiated.

- 3 Turn the JOG dial to find the disc you want.
As you turn the JOG dial, the Disc Memos starting with the input character appear in the display.
- 4 Push the JOG dial to select the disc.

In Program Play mode, the disc will be added to the end of the program.

To cancel Memo Search
Press MEMO SEARCH again.

-  If there is no more Disc Memo starting with the input character in Step 3
The input character changes to the next one when you turn the JOG dial.

Specifying the Next Disc to Play

You can specify the next disc to play while playing a disc in Continuous or 1 DISC Shuffle Play mode.

While playing a disc, turn the JOG dial. "NEXT DISC" appears in the display and the disc number or Disc Memo (see page 23) changes as you turn the JOG dial. When the disc number or Disc Memo you want appears in the display, stop turning the JOG dial.

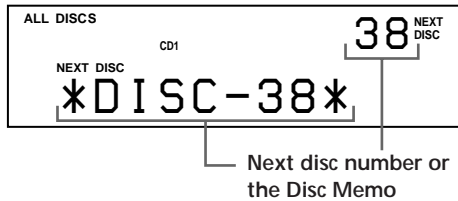

After the current disc is played, the next disc you have specified starts playing.

If you want to skip to the next disc right away, push the JOG dial while playing the current disc.

To cancel the disc you have specified
Press CONTINUE twice.

Locating a Specific Track or a Point in a Track

You can quickly locate any track while playing a disc using the \lll/\ggg (AMS: Automatic Music Sensor) buttons or number buttons on the remote. You can also locate a specific point in a track while playing a disc.

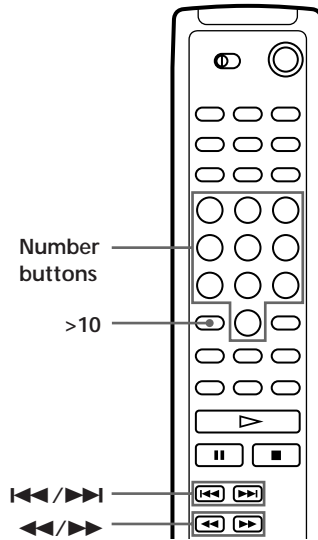
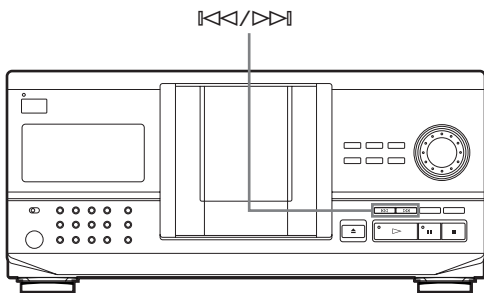

To locate	Press
the next or succeeding tracks	\ggg repeatedly until you find the track
the current or preceding tracks	\lll repeatedly until you find the track
a specific track directly	The number button of the track on the remote
a point in a track while monitoring the sound	\lll (backward)/ \ggg (forward) on the remote and hold down until you find the point
a point in a track quickly by observing the display	\lll (backward)/ \ggg (forward) on the remote and hold down until you find the point during pause. You will not hear the sound during the operation.

When you directly locate a track numbered over 10
Press >10 first, then the corresponding number buttons on the remote.

Note

If "- OVER -" appears in the display, the disc has reached the end while you were pressing \ggg on the remote. Press \lll or \lll on the remote to go back.

Playing Repeatedly

You can play discs/tracks repeatedly in any play mode.

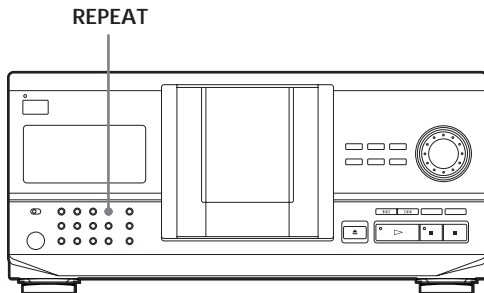

Press REPEAT while playing a disc. "REPEAT" appears in the display. The player repeats the discs/tracks as follows:

When the disc is played in	The player repeats
ALL DISCS Continuous Play (page 10)	All tracks on all discs
1 DISC Continuous Play (page 10)	All tracks on the current disc
ALL DISCS Shuffle Play (page 16)	All tracks on all discs in random order
1 DISC Shuffle Play (page 17)	All tracks on the current disc in random order
Program Play (page 17)	The same program

To cancel Repeat Play
Press REPEAT twice.

Repeating the current track

You can repeat only the current track.

While the track you want is being played, press REPEAT repeatedly until "REPEAT 1" appears in the display.

To cancel Repeat 1
Press REPEAT.

Playing in Random Order (Shuffle Play)

You can have the player "shuffle" the tracks and play in random order. The player shuffles all the tracks on all discs or on the disc you specified.

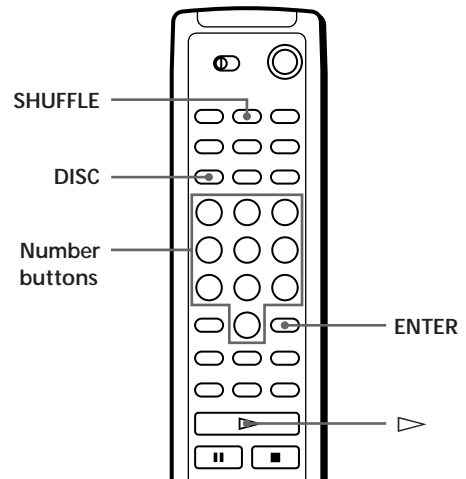
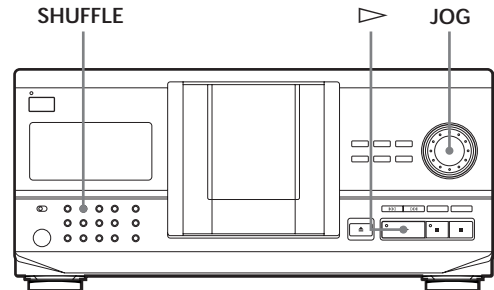



Playing all tracks on all discs in random order

- 1 Press SHUFFLE.
"ALL DISCS" and "SHUFFLE" appear in the display.
- 2 Push the JOG dial or press .
ALL DISCS Shuffle Play starts.
"" appears in the display while the player is "shuffling" the discs or the tracks.

Playing all tracks on a specified disc in random order

- 1 Press SHUFFLE twice.
"1 DISC" and "SHUFFLE" appear in the display.
- 2 Turn the JOG dial until the disc number you want appears in the display.
When using the remote, press DISC first and then press the number button of the disc.
- 3 Push the JOG dial or press ▷.
When using the remote, press ENTER.
1 DISC Shuffle Play starts.
"1 DISC" appears in the display while the player is "shuffling" the tracks.

To cancel Shuffle Play
Press CONTINUE.

- 💡 You can start Shuffle Play while playing
Press SHUFFLE, and Shuffle Play starts from the current track.
- 💡 You can directly select a disc for 1 DISC Shuffle Play 
See "Selecting a disc directly using the remote" on page 14.
- 💡 You can go to the next disc during 1 DISC Shuffle Play 
Press DISC SKIP +.
- 💡 You can specify the next disc to play during 1 DISC Shuffle Play
Turn the JOG dial to specify the next disc. After all the tracks on the current disc are played in random order, the next disc starts playing. If you want to skip to the next disc right away, push the JOG dial while playing the current disc.

Notes

- You cannot specify the next disc to play during ALL DISCS Shuffle Play.
- Even if you press ■ or turn off the player during ALL DISCS Shuffle Play, the player remembers which discs/tracks were played and which were not. Therefore, if you want to start ALL DISCS Shuffle Play again from the beginning, be sure to repeat the procedure from Step 1.

Creating Your Own Program (Program Play)

You can arrange the order of the tracks and/or discs to create three different programs and programs are stored automatically. A program can contain up to 32 "steps" — one "step" may contain a track or a whole disc.

You can make programs using the controls on the remote as well as ones on the player. However, the programming procedures are different.

Creating a program on the player

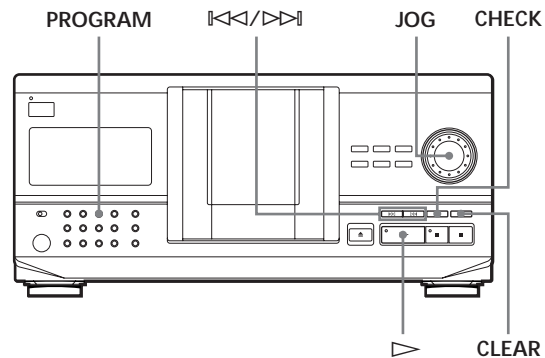

- 1 Press PROGRAM until the program number you want (PROGRAM 1, 2 or 3) appears in the display.
If a program is already stored in the selected program number, the last step of the program appears in the display. When you want to erase the whole program, hold down CLEAR until "CLEAR" appears in the display (see page 19).
- 2 Turn the JOG dial until the disc number you want appears in the display.

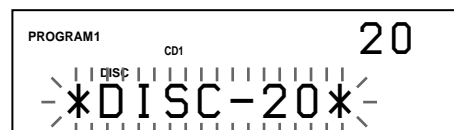

- 3 To program a whole disc, skip this step. Press ◀▶ until the track number you want appears in the display.

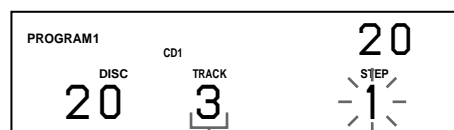

Track number

(Continued)

4 Push the JOG dial.

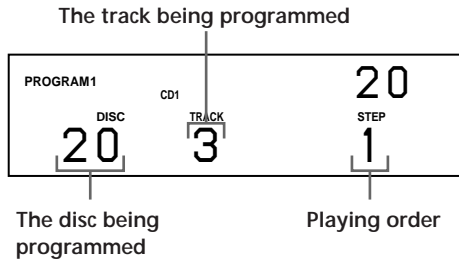

5 To program other discs/tracks, do the following:

To program	Repeat Steps
All tracks of another disc(s)	2 and 4
Other tracks on the same disc	3 and 4
Other tracks on other discs	2 to 4

6 Push the JOG dial or press ▷ to start Program Play.

To cancel Program Play
Press CONTINUE.

💡 The programs remain even after Program Play ends
When you push the JOG dial or press ▷, you can play the same program again.

💡 When you press PROGRAM to select Program Play during Continuous or Shuffle Play
The program will be played after the current track.

💡 The program remains until you erase them
Even if you replace discs, the programmed disc and track numbers remain. So, the player plays only the existing disc and track numbers. However, the disc and track numbers that are not found in the player or on the disc are deleted from the program, and the rest of the program is played in the programmed order.

Note
If you press one of the GROUP 1 – 8 buttons to start Group Play, Program Play will be canceled (see page 27).

Creating a program using the remote

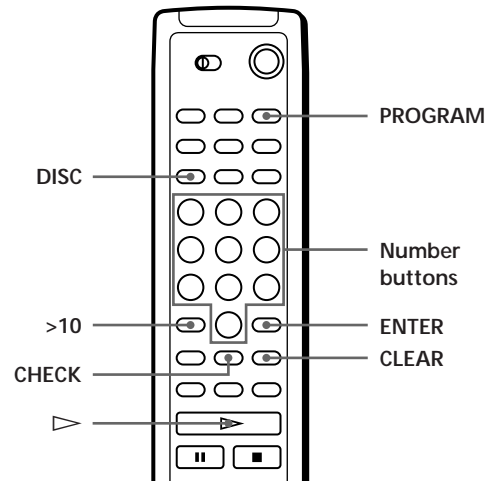

1 Press PROGRAM until the program number you want (PROGRAM 1, 2 or 3) appears in the display.

2 Press DISC.

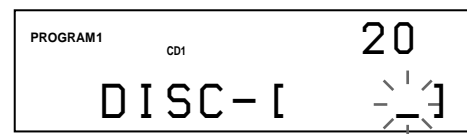

3 Press the number button of the disc.

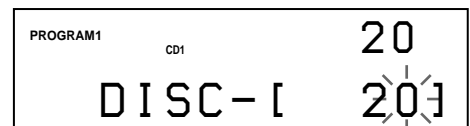

4 To program a whole disc, press ENTER and go to Step 6.
Press >10.

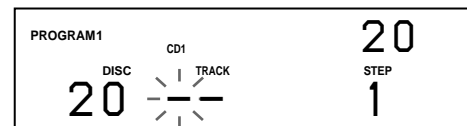

5 Press the number button of the track.
When the disc has more than 10 tracks, press 0 first then press the corresponding number to enter a track number from 1 to 9.

The disc being programmed

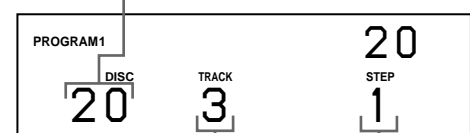

The track being programmed

Playing order

6 To program other discs/tracks, do the following:

To program	Repeat Steps
All tracks of another disc(s)	2 to 4
Other tracks on the same disc	5
Other tracks on other discs	2 to 5

7 Press \triangleright to start Program Play.

To cancel Program Play
Press CONTINUE.

Checking the programmed order

You can check your program before or after you start playing.

Press CHECK.

Each time you press this button, the display shows the disc and track number of each step in the programmed order. (When a whole disc is programmed as one step, "ALL" appears instead of the track number.) After the last step in the program, the display shows "- END -" and returns to the original display.

Changing the programmed order

You can change your program before you start playing.

To	You need to
Erase a track or disc	Press CHECK until the track or disc you do not want appears in the display, then press CLEAR
Erase the last track or disc in the program	Press CLEAR. Each time you press the button, the last track or disc will be cleared.
Add tracks or discs to the end of the program	Follow the programming procedure
Change the whole program completely	Hold down CLEAR until "CLEAR" appears in the display to erase the whole program, then create a new program following the programming procedure

Erasing the program stored in memory

- 1 Press PROGRAM repeatedly in the stop mode until the program number (PROGRAM 1, 2 or 3) you want to erase appears in the display.
- 2 Hold down CLEAR until "CLEAR" appears in the display.

Playing Using a Timer (CDP-CX240 only)

You can start playing a disc at any time you want by connecting a timer (not supplied). Please also refer to the instructions for the timer if you need help.

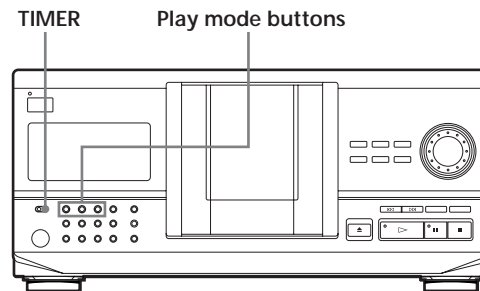

- 1 Press one of the play mode buttons to select the play mode you want.
- 2 Set TIMER on the player to PLAY.
- 3 Set the timer to the time you want. The player turns off. When the set time comes, the player turns on and starts playing.
- 4 After you have used the timer, set TIMER on the player to OFF.

Controlling Another CD Player (Advanced Mega Control) (CDP-CX240 only)

This unit can control a second CD player (see "Connecting Another CD Player" on page 6). Even when a second CD player is connected, the controls on both of the units will function. When you press the play button on either unit, the operating player stops and the resting player starts. Make sure "2nd DETECTED" appears in this player's display after turning on both players. Note that depending on the player, you may not be able to operate all the functions of the second CD player.

The controls indicated in the illustration below are effective while the MEGA CONTROL button is lit.

Play mode buttons
(CONTINUE/SHUFFLE/
PROGRAM/REPEAT) MEGA CONTROL INPUT JOG

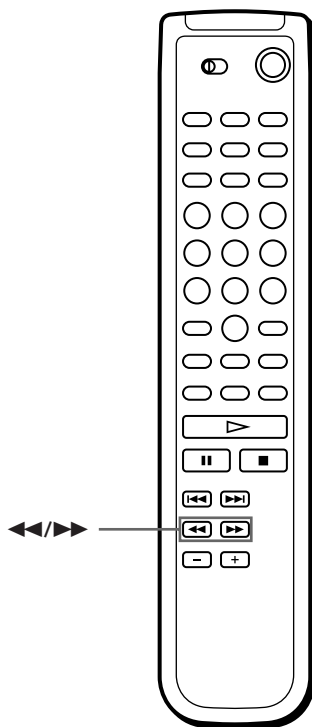
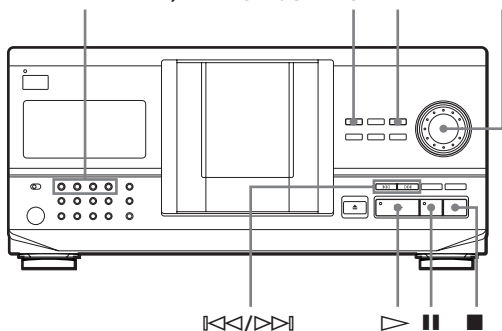

- 1 Press MEGA CONTROL on this player. The MEGA CONTROL button and "2nd" in the display light up. The display shows the current disc number or disc memo of the second player.

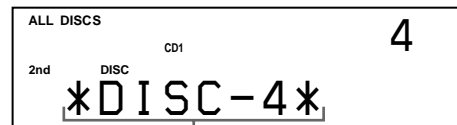

Current disc number or the Disc Memo

- 2 Select the play mode you want. To program tracks, use the controls on the second player. You cannot change the second CD player's ALL DISCS Play mode to 1 DISC Play mode, and vice versa, by using the play mode button on this player.
- 3 Press ▷ on this player to start playing. The play starts and the display shows the current disc and track numbers and the playing time of the track. While the MEGA CONTROL button is lit, you can control the second player with the controls on this player.

To control the second player directly using the supplied remote

Set CD 1/2/3 on the remote to CD 3 which is the same position as the COMMAND MODE selector on the rear panel of the second player.

To control this player again

Press MEGA CONTROL. The MEGA CONTROL button goes off and you can control this player.

Loading the Disc Memos of the second CD player

If the second CD player has the Disc Memo function (see page 23), you can load the Disc Memos of the second CD player to this player's memory and display them on this player.

- 1 Press INPUT.
- 2 Turn the JOG dial until "LOAD 2ND MEMO" appears in the display.

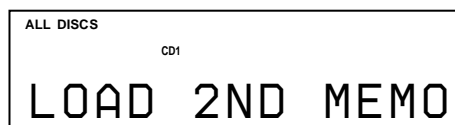

- 3 Push the JOG dial.
This player starts loading. (Loading takes about one minute.)

Note

If each Disc Memo of the second CD player has more than 13 characters, the first 13 characters of each are loaded to this player.

Labeling discs of the second CD player

You can label discs of the second CD player or change the Disc Memos loaded from the second CD player.

- 1 Press MEGA CONTROL.
The MEGA CONTROL button lights up.
- 2 Turn the JOG dial to select the disc you want to assign a Disc Memo to.
If the disc slot you select does not have any disc, "NO DISC" appears in the display and you cannot assign a Disc Memo.
- 3 Press INPUT.
"DISC MEMO" appears.
- 4 Push the JOG dial.
- 5 Input the new Disc Memo following the procedure in "Labeling Discs" on pages 23 to 25.

Note



The new Disc Memos are stored on this player's memory, so you cannot display them on the second CD player.

Fading In or Out (CDP-CX240 only)

You can manually fade the sound in or out to prevent tracks from starting or ending abruptly.

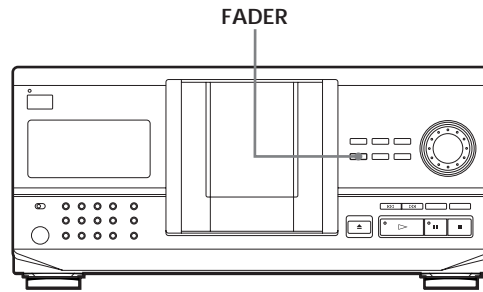
Note that you cannot use this effect when you use the DIGITAL OUT (OPTICAL) connector.



To	Press FADER
Start play fading in	During pause. "FADE" appears in the display and the  indication flashes. The play fades in.
End play fading out	When you want to start fading out. "FADE" appears in the display and the  indication flashes. The play fades out and the player pauses.

Note

Fading lasts for about 5 seconds.

Playing Alternately (No-Delay Play/X-Fade Play) (CDP-CX240 only)

When you connect the second player, you can play tracks in this player and those in the second player alternately in any play mode (see “Connecting Another CD Player” on page 6).

Select one of the following methods:

- **No-Delay Play:** The current player changes at each track. Each time the current player changes to the other player, the other player starts play without a break in sound immediately after the current player ends play. The other player skips the lead-in portion and starts playing from where the sound actually begins.
- **X-Fade Play:** The current player changes at each track or at the specified interval. You can select the interval among 30, 60 and 90 seconds. Each time the current player changes to the other player, the sound from both players is mixed. The current player ends play by fading out, and the other player starts play by fading in.

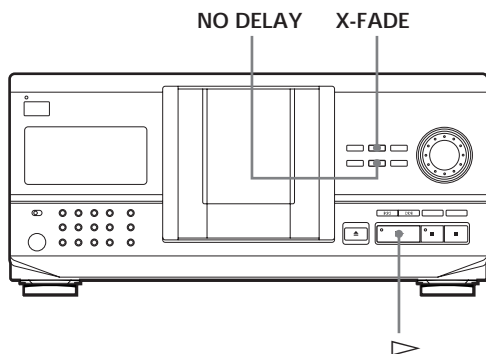

1 Select the play mode you want on each player.

2 When you select No-Delay Play

Press NO DELAY.

“NO DELAY” appears in the display.

When you select X-Fade Play

Press X-FADE.

“X-FADE” appears in the display.

Each time you press the X-FADE button, the indication appears as follows:

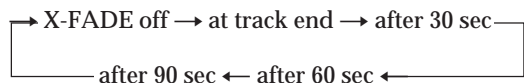

To change the current player each time a whole track is finished, select “at track end.”

To change the current player at the specified interval, press X-FADE repeatedly until the interval you want appears in the display.

3 Press \blacktriangleright to start playing.

The MEGA CONTROL button lights up while the track in the second player is selected.

To cancel No-Delay/X-Fade Play

Press the corresponding button repeatedly until “NO DELAY” or “X-FADE” disappears from the display. The current player continues playing.

💡 You can change the method (No-Delay or X-Fade) during play

Press the corresponding button (NO DELAY or X-FADE) following the procedure in Step 2.

💡 You can start X-Fade whenever you like

Press FADER during X-Fade Play. Even after you have set the X-Fade mode and started X-Fade play, you can start X-Fade manually at any point you like. Note that you cannot do this operation while the sound from both players is mixed.

Notes

- The play starts from the second player if you start play while the MEGA CONTROL button is lit.
- When one player has played all the discs/tracks in the player ahead of the other player, the play stops.
- Do not use the controls on the second player during No-Delay/X-Fade Play. They may not work correctly.

What You Can Do With the Custom Files

The player can store two types of information called “Custom Files” for each disc. Once you have stored Custom Files for a disc, the player automatically recalls what you have stored whenever you select the disc. Note that Custom Files will be erased if you do not use the player for about one month.

You can store this information:

When you use	You can
Disc Memo (page 23)	Label discs using up to 13 characters
Delete Bank (page 26)	Delete unwanted tracks and store only the tracks you want
Group File (page 27)	Group discs up to eight groups to locate them easily

Where are Custom Files stored?

Custom Files are stored not on the disc, but in the player’s memory. It means you cannot use Custom Files when you play the disc on other players.

If you replace discs you have filed in the Custom Files

The Custom File information you have stored remains, since each Custom File information is assigned to each slot. Erase all Custom Files (Disc Memo, Delete Bank and Group File) of the old disc, and then file the new disc information in the Custom Files.

Erasing all Custom Files of all discs

Turn off the player. While holding down CLEAR, press I/O to turn on the player. “ALL ERASE” appears in the display, and all Custom Files will be erased.

Labeling Discs (Disc Memo)

You can label discs using up to 13 characters and have the player display the Disc Memo each time you select the disc. The Disc Memo can be anything you like, such as a title, musician’s name, category or date of purchase.



When you select a CD TEXT disc

The disc title is stored as the Disc Memo automatically. If the disc title has more than 13 characters, the first 13 characters of the disc title are stored (see page 12).

When you replace a disc with a CD TEXT disc, the disc title of the CD TEXT disc is also stored automatically. Note that you cannot change the Disc Memo of the CD TEXT disc.



You can label discs while the front cover is open

Labeling discs on the player

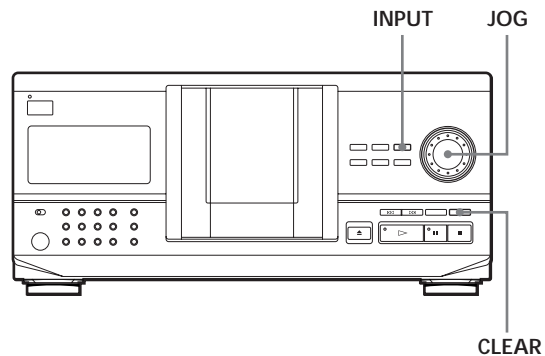

- 1 Turn the JOG dial until the disc number to which you want to assign a Disc Memo appears in the display.
When you label a disc with the front cover closed, the disc number of the disc at the playing position appears.
When you label a disc with the front cover open, the disc number at the loading position appears.
- 2 Press INPUT.
“DISC MEMO” flashes.
- 3 Push the JOG dial.
The flashing cursor (◀) appears.

(Continued)

Storing Information About CDs (Custom Files)

- 4** Turn the JOG dial until the character you want appears in the display.
The cursor disappears and the first space for the Disc Memo flashes.
As you turn the JOG dial clockwise, the characters appear in the following order. Turn the JOG dial counterclockwise to go back to the previous character.

(space) A B C D E F G H I J K L M N O P Q R S T U
V W X Y Z a b c d e f g h i j k l m n o p q r s t u v w
x y z 0 1 2 3 4 5 6 7 8 9 ! " # \$ % & ' () * + , - . / : ; <
= > ? @ [\] ^ _ ` { | } ~

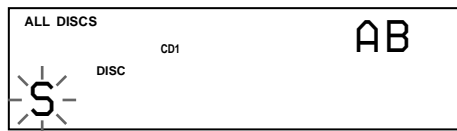

- 5** Push the JOG dial to select the character.
The selected character lights up, and the flashing cursor appears to indicate the next space to be input.

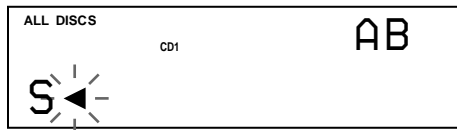

If you have made a mistake
Press CLEAR and begin again by inputting the correct characters.

- 6** Repeat Steps 4 and 5 to input more characters.
7 Press INPUT to store the Disc Memo.
The display shows the Disc Memo.



Repeat Steps 1 to 7 to assign Disc Memos to other discs.

Labeling discs using the remote

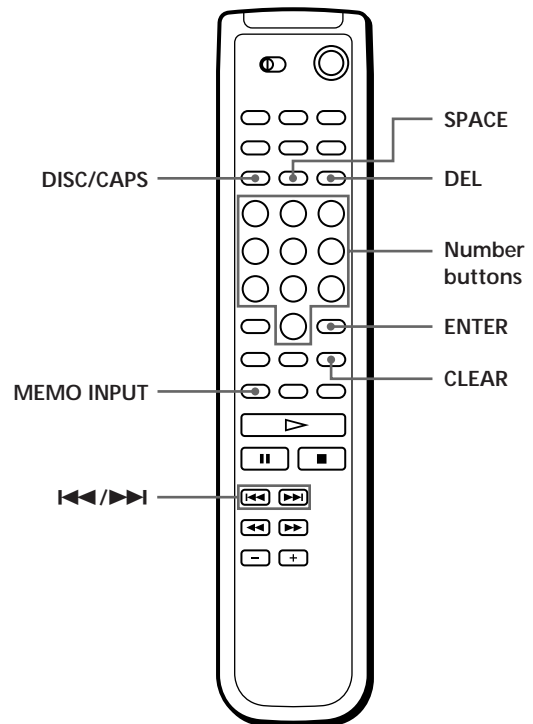

- 1** Press DISC/CAPS.
- 2** Press the number button of the disc you want to assign a Disc Memo, and then ENTER.
- 3** Press MEMO INPUT.
The flashing cursor (◀) appears.
- 4** Press DISC/CAPS to find the letter type you want. Each time you press the button, the letter type changes cyclically among capital letters (AB), small letters (ab) and numbers (12). To select a symbol, you have to select the capital or small letter type. The selected letter type appears in the upper right of the display.

- 5** To input a letter, press the number button corresponding to the letter you want (indicated beside each number button). The cursor disappears and the first space for the Disc Memo flashes. Each time you press the button, the letter changes cyclically among the ones indicated beside the button.

To input symbols, press the number button 1 repeatedly until the symbol you want appears in the display.

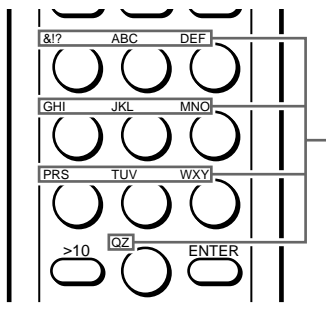

Characters assigned to each number button

Example: To select the letter E
Press the number button 3 twice.

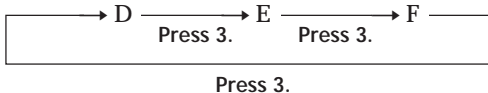

To insert a space, press SPACE once.

To input a number press the number button you want.

- 6** Press ENTER to select the character. The selected character lights up, and the flashing cursor appears to indicate the next space to be input. You can also go to the next space by pressing other number buttons.
- 7** Repeat Steps 4 through 6 to input more characters.
- 8** Press MEMO INPUT to store the Disc Memo. The Disc Memo lights up in the display.



Repeat Steps 1 through 8 to assign Disc Memos to other discs.

💡 If you have made a mistake while inputting the character

To correct the character which has been input

- 1 Press ◀◀ or ▶▶ until the cursor moves next to the incorrect character.



- 2 Press DEL to delete the incorrect character.



- 3 Input the correct character.



To correct the character currently being input

- 1 Press DEL to delete the incorrect character.
- 2 Input the correct character.

To insert a character between the input characters
Press ◀◀ or ▶▶ until the cursor moves next to the point you want to insert, and enter the character.

💡 You can label discs of the second CD player
See "Labeling discs of the second CD player" on page 21.

Erasing the Disc Memo

- 1 Follow Steps 1 through 3 in "Labeling discs on the player" on page 23 to select the Disc Memo you want to erase.
- 2 Press CLEAR. The Disc Memo disappears.

Storing Custom File Information Using a Keyboard (CDP-CX240 only)

You can store the Disc Memo for one disc sequentially using an IBM-compatible PC keyboard* (not supplied).

* Power consumption must be 120 mA or less.

Keyboard jack

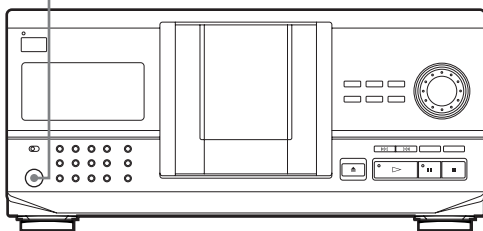

- 1 Connect a keyboard to the keyboard jack on the front panel of the player.

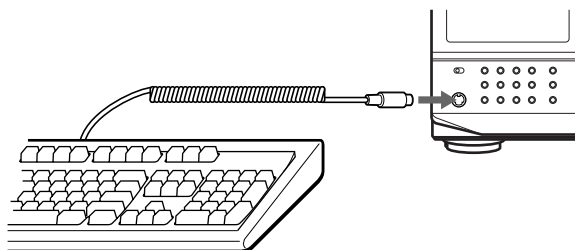

- 2 After selecting the disc you want on the player, press the Enter key.
- 3 Input the characters you want, then press the Enter key or Esc key to store the information.

You can delete all characters of selected item
While holding down the Shift key, press the Delete key.

Notes

- If the cursor keys do not work correctly and you cannot complete the task using the keyboard, disconnect the keyboard then reconnect it to the player.
- If the keyboard is not the USA model, the characters may be input differently from those on the keys. The USA keyboard layout is shown below.

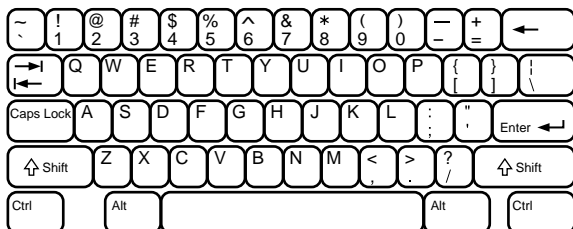

Storing Specific Tracks (Delete Bank)

You can delete unwanted tracks and store only the tracks you want. When you select the disc containing a Delete Bank, you can play only the remaining tracks.

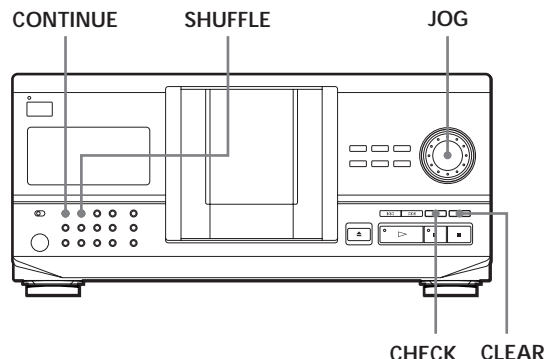

- 1 Press CONTINUE or SHUFFLE before you start playing.
- 2 Turn the JOG dial to select the disc.
- 3 Press CHECK repeatedly until the track you want to delete appears in the display.

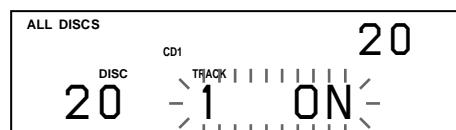

- 4 Press CLEAR. "DELETE FILE" and "OFF" appear in the display.

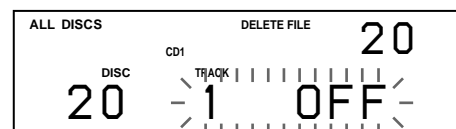

If you want to recover the track, press CLEAR again.

- 5 Repeat Steps 3 and 4 to delete more tracks.

You can recover all the tracks you have deleted
Hold down CLEAR until "ALL ON" appears in the display.

Note

The deleted tracks are skipped even in the Shuffle or Program Play mode (when the whole disc containing a Delete Bank is programmed as one step).

Grouping Discs (Group File)

You might find that too many discs make it hard to find the disc you want. This player has a feature that lets you classify discs into eight groups. One disc can be put into only one group.

Once you classify discs, you can enjoy Continuous, Shuffle or Repeat Play only within a certain group (Group Play).

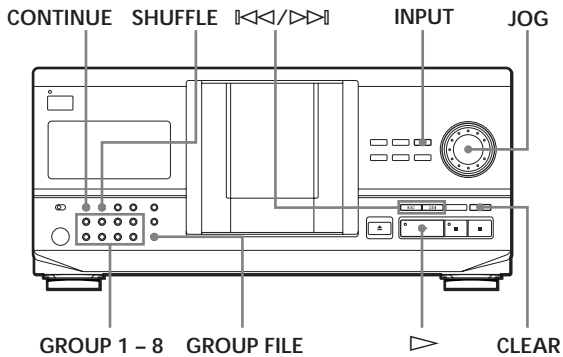

Assigning discs to groups

- 1 Press CONTINUE or SHUFFLE before you start playing.
- 2 Turn the JOG dial to select the disc you want to assign to a group.
- 3 Press GROUP FILE.
"Select G1 - G8" appears in the display.
- 4 Press one of the GROUP 1 - 8 buttons to which you want to put the disc.
"GROUP FILE" and the group number appear in the display and the disc is assign to that group.

Labeling groups (Group Memo)

You can change the preset group number to anything you like, such as a category, using up to 13 characters. Note that you cannot store the Group Memo if you have not assign any disc to the group.

- 1 Press INPUT.
- 2 Turn the JOG dial until the group number you want to label appears in the display, and then push the JOG dial.
The flashing cursor (◀) appears.

- 3 Turn the JOG dial until the character you want appears in the display.
The cursor disappears and the first space for the Group Memo flashes.
As you turn the JOG dial clockwise, the characters appear in the following order. Turn the JOG dial counterclockwise to go back to the previous character.

(space) A B C D E F G H I J K L M N O P Q R S T U
V W X Y Z a b c d e f g h i j k l m n o p q r s t u v w
x y z 0 1 2 3 4 5 6 7 8 9 ! " # \$ % & ' () * + , - . / : ; <
= > ? @ [\] ^ _ \ { | } ~

- 4 Push the JOG dial to select the character.
The selected character lights up, and the flashing cursor appears to indicate the next space to be input.

If you have made a mistake

Press CLEAR and begin again by inputting the correct characters.

- 5 Repeat Steps 3 and 4 to input more characters.
See also "Labeling discs on the player" on page 23 for details.
- 6 Press INPUT to store the Group Memo.

Erasing the Group Memo

- 1 Follow Steps 1 and 2 in "Labeling groups" to select the Group Memo you want to erase.
- 2 Press CLEAR.
The Group Memo disappears.

Playing discs in a group (Group Play)

You can enjoy Continuous or Shuffle Play within a group.

- 1 Select the play mode you want before you start playing.

When you select	The player plays
ALL DISCS Continuous Play	All tracks on all discs in the group consecutively
1 DISC Continuous Play	All tracks on the specified disc in the group consecutively
ALL DISCS Shuffle Play	All tracks on all discs in the group in random order
1 DISC Shuffle Play	All tracks on the specified disc in the group in random order

Storing Information About CDs (Custom Files)

- 2 Press one of the GROUP 1 – 8 buttons to select the group and press \triangleright .

Group Play starts from the disc which is the most upward number and located closest to the playing position. If the disc at the playing position is put into the selected group, the play starts from that disc.

To cancel Group Play

Press one of the GROUP 1 – 8 buttons you have selected. "GROUP OFF" appears in the display.

You can start Group Play with the remote

- 1 Before you start playing, press GROUP.
 - 2 Press the number button of the group you want to play, then press ENTER.
 - 3 Press \triangleright .
- To cancel Group Play, press GROUP.

You can specify the disc to play when starting Group Play

After selecting the group, turn the JOG dial to select the disc, then push the JOG dial or press \triangleright .

When using the remote, press DISC SKIP repeatedly until the disc number you want appears in the display, then press ENTER.

Note

If "NO ENTRY" appears in the display, no disc has been put into the selected group.

Locating a disc within a group by scanning each Disc Memo

You can locate a disc you want to play within a specific group quickly by scanning the Disc Memo in the display and then start Group Play.

Note that you cannot use this function in the ALL DISCS Shuffle and Program play mode.

- 1 Press GROUP first, then the number button of the group you want.
- 2 Press ENTER.
The group name appears in the display.
- 3 Press MEMO SCAN.
"MEMO SCAN" appears in the display.
The Disc Memos of the discs in the selected group scroll in the display.
- 4 Press ENTER or \triangleright when the Disc Memo of the disc you want appears.
Group Play starts from the selected disc.

You can jump to the next or preceding Disc Memo while scanning

Press \lll or \ggg .

Deleting discs from a group

- To delete a disc from a group
 - 1 Turn the JOG dial until the disc number you want to delete from the group appears in the display.
 - 2 Press GROUP FILE.
"Select G1 – G8" appears in the display.
 - 3 Press CLEAR.
"GROUP ERASE" appears in the display.
- To delete all discs from a group at once
While holding down one of the GROUP 1 – 8 buttons you want to clear, press CLEAR.

Storing Your Favorite Tracks (Hit List) (CDP-CX240 only)

You can store the tracks you play frequently and select those tracks immediately by checking the track numbers or titles (see page 29) in the Hit List. You can put up to 32 tracks in the Hit List.

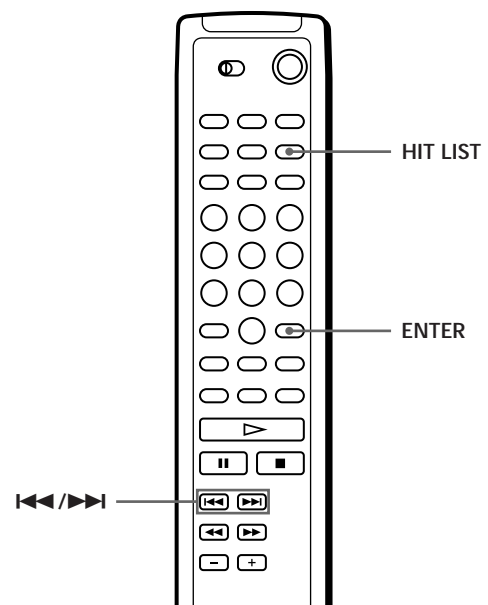
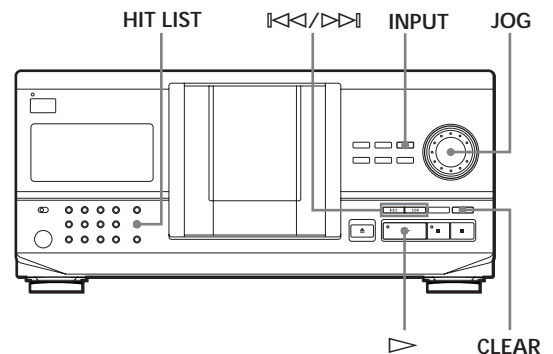

Putting tracks into the Hit List

Press HIT LIST while playing your favorite track. "HIT" indication and "List in" appear in the display.

Playing tracks in the Hit List

- 1 Press HIT LIST before you start playing. The HIT LIST button lights up and "HIT LIST" appears in the display.
- 2 Turn the JOG dial or press \lll/\ggg until the track you want appears in the front panel display.
- 3 Push the JOG dial or press \triangleright to start playing. When using the remote, press ENTER.

 The Hit List remains until you erase them
Even if you replace discs, the Hit List you create remains. So, the player plays only the existing track.

Notes

- You cannot arrange the order of the tracks in the Hit List.
- The track you select in Step 2 will be listed as the first track in the Hit List.
- If you input the 33rd track into the Hit List, the 32nd track will be replaced.
- You cannot store the tracks from a second CD player.

Deleting tracks from the Hit List

- 1 Follow Steps 1 and 2 in "Playing tracks in the Hit List."
- 2 Press CLEAR.
The selected track is deleted from the Hit list.

Deleting all tracks of the Hit List

Hold down CLEAR while in stop mode until "CLEAR" appears.

Labeling tracks in the Hit List (Hit Title)

You can label tracks in the Hit List in either of two methods described below.

Labeling tracks while in play mode

- 1 Press INPUT while playing a track in the Hit List. "Hit Title" appears in the display.
- 2 Push the JOG dial.
The flashing cursor (\blacktriangleleft) appears in the display.

- 3 Turn the JOG dial until the character you want appears in the display.
The cursor disappears and the first space for the Hit Title flashes.
As you turn the JOG dial clockwise, the characters appear in the following order. Turn the JOG dial counterclockwise to go back to the previous character.

(space) A B C D E F G H I J K L M N O P Q R S T U
V W X Y Z a b c d e f g h i j k l m n o p q r s t u v w
x y z 0 1 2 3 4 5 6 7 8 9 ! " # \$ % & ' () * + , - . / : ; <
= > ? @ [\] ^ _ ` { | } ~

- 4 Push the JOG dial to select the character.
The selected character lights up, and the flashing cursor appears to indicate the next space to be input.

If you have made a mistake

Press CLEAR and begin again by inputting the correct characters.

- 5 Repeat Steps 3 and 4 to input more characters.
See also "Labeling discs on the player" on page 23 for details.
- 6 Press INPUT to store the Hit Title.

Labeling tracks while in stop mode

- 1 Select the track you want to assign by turning the JOG dial or press \lll/\ggg .
- 2 Press INPUT.
The flashing cursor (\blacktriangleleft) appears in the display.
- 3 Follow Steps 3 to 6 in "Labeling tracks while in play mode" to input the characters.

 You can store the CD TEXT disc's track titles in the Hit List
Push the JOG dial twice (while in play mode) or press INPUT twice (while in stop mode) when the track title appears in Step 2.

Precautions

On safety

- Caution — The use of optical instruments with this product will increase eye hazard.
- Should any solid object or liquid fall into the cabinet, unplug the player and have it checked by qualified personnel before operating it any further.

On power sources

- Before operating the player, check that the operating voltage of the player is identical with your local power supply. The operating voltage is indicated on the nameplate at the rear of the player.
- The player is not disconnected from the AC power source (mains) as long as it is connected to the wall outlet, even if the player itself has been turned off.
- If you are not going to use the player for a long time, be sure to disconnect the player from the wall outlet. To disconnect the AC power cord (mains lead), grasp the plug itself; never pull the cord.
- AC power cord must be changed only at the qualified service shop.
- The unswitched socket outlets remain live, independently of power switch setting, at all times when the unit is connected to the AC power supply.

On placement

- Place the player in a location with adequate ventilation to prevent heat build-up in the player.
- Do not place the player on a soft surface such as a rug that might block the ventilation holes on the bottom.
- Do not place the player in a location near heat sources, or in a place subject to direct sunlight, excessive dust or mechanical shock.

On operation

- If the player is brought directly from a cold to a warm location, or is placed in a very damp room, moisture may condense on the lenses inside the player. Should this occur, the player may not operate properly. In this case, leave the player turned on for about an hour until the moisture evaporates.

On adjusting volume

- Do not turn up the volume while listening to a portion with very low level inputs or no audio signals. If you do, the speakers may be damaged when a peak level portion is played.

On cleaning

- Clean the cabinet, panel and controls with a soft cloth slightly moistened with a mild detergent solution. Do not use any type of abrasive pad, scouring powder or solvent such as alcohol or benzine.

On transportation

- When transporting the player, open the front cover then remove all the discs from the player and turn the power off.

If you have any questions or problems concerning your player, please consult your nearest Sony dealer.

Notes on CDs

On handling CDs

- To keep the disc clean, handle the disc carefully.
- Do not stick paper or tape on the disc.

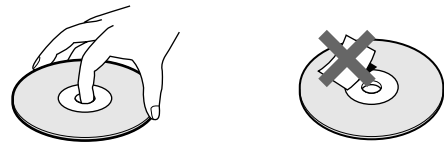

- Do not expose the disc to direct sunlight or heat sources such as hot air ducts, nor leave it in a car parked in direct sunlight as there can be considerable rise in temperature inside the car.
- After removing a disc from the disc slot, store the disc in its case.

On cleaning

- Before playing, clean the disc with a cleaning cloth. Wipe the disc from the center out.

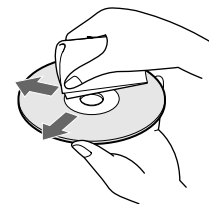

- Do not use solvents such as benzine, thinner, commercially available cleaners or anti-static spray intended for vinyl LPs.

Troubleshooting

If you experience any of the following difficulties while using the player, use this troubleshooting guide to help you remedy the problem. Should any problem persist, consult your nearest Sony dealer.

There is no sound.

- ➔ Check that the player is connected securely.
- ➔ Make sure you operate the amplifier correctly.

The CD does not play.

- ➔ There is no CD in a slot (“-NO DISC-” appears).
Insert a CD.
- ➔ Insert the CD with the label side facing right.
- ➔ Clean the CD (see page 30).
- ➔ Moisture has condensed inside the player. Open the front cover and leave the player turned on for about an hour (see page 30).

The remote does not function.

- ➔ Remove obstacles in the path of the remote and the player.
- ➔ Point the remote at the remote sensor  on the player.
- ➔ Replace all the batteries in the remote with new ones if they are weak.
- ➔ Set the CD 1/2/3 switch on the remote according to the position of the COMMAND MODE selector displayed in the front panel display (see page 5).

The player functions incorrectly.

- ➔ The microcomputer chips may be operating incorrectly. Disconnect the AC power cord, then connect it back to the wall outlet to reset the player.

Specifications

Compact disc player

Laser	Semiconductor laser ($\lambda = 780 \text{ nm}$) Emission duration: continuous
Laser output	Max 44.6 μW * * This output is the value measured at a distance of 200 mm from the objective lens surface on the Optical Pick-up block with 7 mm aperture.
Frequency response	20 Hz to 20 kHz $\pm 0.5 \text{ dB}$
Signal-to-noise ratio	CDP-CX240: More than 107 dB CDP-CX220: More than 105 dB
Dynamic range	More than 98 dB
Harmonic distortion	Less than 0.0045 %
Channel separation	CDP-CX240: More than 100 dB CDP-CX220: More than 97 dB

Outputs

	Jack type	Maximum output level	Load impedance
LINE OUT	Phono jacks	2 V (at 50 kilohms)	Over 10 kilohms
DIGITAL OUT (OPTICAL)	Optical output connector	-18 dBm	Wave length: 660 nm

General

Power requirements

Where purchased	Power requirements
USA	120 V AC, 60 Hz
Australia	240 V AC, 50/60 Hz
Europe/Certain countries in Asia	220 V – 230 V AC, 50/60 Hz
Other countries	110 V – 120 V or 220 V – 240 V AC, adjustable, 50/60 Hz

Power consumption	12 W
Dimensions (approx.) (w/h/d)	When the front cover is closed 430 × 200 × 480 mm (17 × 7 7/8 × 19 in.) incl. projecting parts
Mass (approx.)	9.5 kg (21 lbs)

Supplied accessories

- Audio cord (2 phono plugs – 2 phono plugs) (1)
- Remote commander (remote) (1)
- Sony SUM-3 (NS) batteries (2)
- CD booklet holders (2) and label (1)

Design and specifications are subject to change without notice.

Index

A, B

- Advanced Mega Control 20
- AMS 15
- Automatic Music Sensor 15

C

- CD TEXT 12
- Connecting 4
 - another CD player 6
- Continuous Play 10
- CONTROL A1 5
- X-Fade Play 22
- Custom Files
 - Delete Bank 26
 - Disc Memo 23
 - Group File 27
 - Hit List 28
 - what you can do with 23

D

- Delete Bank 26
- Disc Memo 23

E

- Erasing
 - Custom Files 23
 - Delete Bank 26
 - Disc Memo 25
 - Group Memo 27
 - programs 19

F

- Fading 21

G

- Grouping Discs 27

H

- Handling CDs 30
- Hookups
 - overview 4

I

- Inserting CDs 7

J, K

- JOG dial 7

L

- Labeling a disc 23
- Locating
 - a specific point 15
 - a specific track 15
 - by monitoring 15
 - by observing the display 15
 - directly 15
 - discs 14
 - using AMS 15

M

- Memo Scan 14
- Memo Search 14

N, O

- No-Delay Play 22

P, Q

- Playback
 - Continuous Play 10
 - Group Play 27
 - Program Play 17
 - Repeat Play 16
 - Shuffle Play 16
- Program
 - changing 19
 - checking 19
 - erasing 19

R

- Remote control 4
- Repeating 16
- Rotary table 7

S

- Searching. *See* Locating
- Selecting a disc 14
- Selecting the language 13
- Shuffle Play
 - on all discs 16
 - on one disc 17
- Specifying the next disc 15
- Storing
 - information about CDs 23
 - specific tracks 26

T

- Timer Play 19
- Total playing time 12
- Troubleshooting 31

U, V, W, X, Y, Z

- Unpacking 4

Names of controls

Buttons

- CHECK 19, 26
- CLEAR 17, 25, 26
- CONTINUE 15
- X-FADE 22
- DEL 25
- DISC 14, 18
- DISC/CAPS 24
- DISC SKIP 11
- ENTER 14, 18, 28
- GROUP 28
- GROUP 1 - 8 27
- GROUP FILE 27
- HIGH-LIGHT 13
- HIT LIST 29
- INPUT 24, 29
- MEGA CONTROL 21
- MEMO INPUT 24
- MEMO SCAN 14
- MEMO SEARCH 14
- NO DELAY 22
- Number 14, 15
- ≡ OPEN/CLOSE 7
- PROGRAM 17
- REPEAT 16
- SHUFFLE 16
- SPACE 25
- TIME/TEXT 12
- ⏪/⏩ 11
- ▷ 11
- ⏮ 11
- 11
- ⏪/⏩ 15
- ◀/▶ 15
- >10 15

Switches

- CD 1/2/3 5
- TIMER 19
- I/⏻ 7

Jacks

- LINE OUT 5
- S-LINK/CONTROL A1 4
- 2ND CD IN 6

Connectors

- DIGITAL OUT (OPTICAL) 5

Others

- COMMAND MODE selector 5
- Disc slots 7
- Display 12
- Front cover 7
- JOG dial 7
- Rotary table 7
- Ⓜ 4