

FM Stereo FM-AM Receiver

Operating Instructions _____

EN

C1

***STR-DE925
STR-DE825***

WARNING

To prevent fire or shock hazard, do not expose the unit to rain or moisture.

Precautions

On safety

Should any solid object or liquid fall into the cabinet, unplug the receiver and have it checked by qualified personnel before operating it any further.

On power sources

- Before operating the receiver, check that the operating voltage is identical with your local power supply. The operating voltage is indicated on the nameplate at the rear of the receiver.
- The unit is not disconnected from the AC power source (mains) as long as it is connected to the wall outlet, even if the unit itself has been turned off.
- If you are not going to use the receiver for a long time, be sure to disconnect the receiver from the wall outlet. To disconnect the AC power cord, grasp the plug itself; never pull the cord.
- One blade of the plug is wider than the other for the purpose of safety and will fit into the wall outlet only one way. If you are unable to insert the plug fully into the outlet, contact your dealer.
- AC power cord must be changed only at the qualified service shop.

On placement

- Place the receiver in a location with adequate ventilation to prevent heat buildup and prolong the life of the receiver.
- Do not place the receiver near heat sources, or in a place subject to direct sunlight, excessive dust or mechanical shock.
- Do not place anything on top of the cabinet that might block the ventilation holes and cause malfunctions.

On operation

Before connecting other components, be sure to turn off and unplug the receiver.

On cleaning

Clean the cabinet, panel and controls with a soft cloth slightly moistened with a mild detergent solution. Do not use any type of abrasive pad, scouring powder or solvent such as alcohol or benzine.

If you have any question or problem concerning your receiver, please consult your nearest Sony dealer.

About This Manual

The instructions in this manual are for models STR-DE925 and STR-DE825. Check your model number by looking at the upper right corner of the front panel. In this manual, the STR-DE925 is used for illustration purposes unless stated otherwise. Any difference in operation is clearly indicated in the text, for example, "STR-DE925 only."

Type of differences

Model	DE925	DE825
DTS compatible	●	
5 audio/video inputs	●	
4 audio/video inputs		●

Conventions

- The instructions in this manual describe the controls on the receiver. You can also use the controls on the supplied remote if they have the same or similar names as those on the receiver. For details on the use of your remote, refer to the separate operating instructions supplied with the remote.
- The following icon is used in this manual:
☞ Indicates hints and tips for making the task easier.

This receiver incorporates the Dolby* Pro Logic Surround system and the DTS** Digital Surround System (only the STR-DE925 is DTS compatible).

* Manufactured under license from Dolby Laboratories Licensing Corporation. DOLBY, the double-D symbol , "PRO LOGIC," and Dolby Digital (AC-3) are trademarks of Dolby Laboratories Licensing Corporation.

**Manufactured under license from Digital Theater Systems, Inc. US Pat. No. 5,451,942 and other worldwide patents issues and pending. "DTS" and "DTS Digital Surround" are trademarks of Digital Theater Systems, Inc. © 1996 Digital Theater Systems, Inc. All rights reserved.

Demonstration Mode

The demonstration will activate the first time you turn on the power. When the demonstration starts, the following message appears in the display twice:

"Now Demonstration Mode!! If you finish demonstration, please press POWER KEY while this message appears in the display. Thank you!!"

To cancel the demonstration

Press I/⏻ to turn the receiver off during the previous message. The next time you turn the receiver on, the demonstration will not appear.

To view the demonstration

Hold down SET UP and press I/⏻ to turn on the power.

Note

Running the demonstration will clear the receiver's memory. For details on what will be cleared, see "Clearing the receiver's memory" on page 19.

TABLE OF CONTENTS

Hooking Up the Components 4

- Unpacking 4
- Antenna Hookups 5
- Audio Component Hookups 6
- Video Component Hookups 8
- Digital Component Hookups 9
- Other Hookups 11

Hooking Up and Setting Up the Speaker System 12

- Speaker System Hookup 13
- Multi-Channel Surround Setup 14
- Before You Use Your Receiver 19

Location of Parts and Basic Amplifier Operations 22

- Front Panel Parts Description 22

Enjoying Surround Sound 26

- Selecting a Sound Field 27
- Understanding the Multi-Channel Surround Displays 31
- Customizing Sound Fields 33

Receiving Broadcasts 37

- Direct Tuning 38
- Automatic Tuning 39
- Preset Tuning 39

Other Operations 41

- Indexing Preset Stations and Program Sources 42
- Recording 42
- Using the Sleep Timer 43
- Adjustments Using the SET UP Button 44

Additional Information 45

- Troubleshooting 45
- Specifications 47
- Glossary 49
- Tables of Settings Using the CURSOR MODE and SET UP buttons 50
- Index 52

Hooking Up the Components

This chapter describes how to connect various audio and video components to the receiver. Be sure to read the sections for the components you have before you actually connect them to the receiver.

Unpacking

Check that you received the following items with the remote:

- FM wire antenna (1)
- AM loop antenna (1)
- Remote commander RM-LJ301 (remote) (1)
- LR6 (size-AA) alkaline batteries (3)

Inserting batteries into the remote

Insert three size-AA (LR6) alkaline batteries with the + and – properly oriented in the battery compartment. When using the remote, point it at the remote sensor  on the receiver.

For details, refer to the operating instructions supplied with your remote.



When to replace batteries

Under normal conditions, the batteries should last for about 3 months. When the remote no longer operates the receiver, replace all batteries with new ones.

Notes

- Do not leave the remote in an extremely hot or humid place.
- Do not use new batteries with old ones.
- This remote is designed for use with alkaline batteries only. Do not use a combination of different battery types.
- Do not expose the remote sensor to direct sunlight or lighting apparatuses. Doing so may cause a malfunction.
- If you don't use the remote for an extended period of time, remove the batteries to avoid possible damage from battery leakage and corrosion.

Before you get started

- Turn off the power to all components before making any connections.
- Do not connect the AC power cords until all of the connections are completed.
- Be sure to make connections firmly to avoid hum and noise.
- When connecting an audio/video cord, be sure to match the color-coded pins to the appropriate jacks on the components: yellow (video) to yellow; white (left, audio) to white; and red (right, audio) to red.

Antenna Hookups

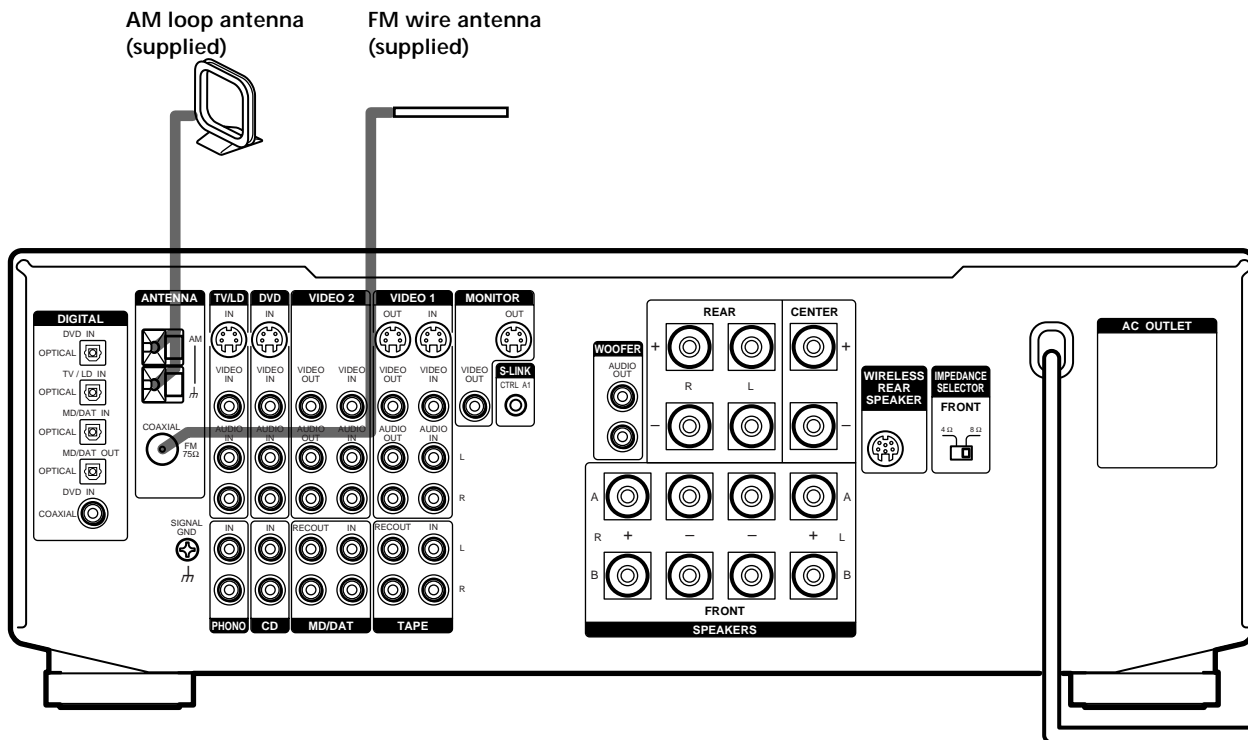

Terminals for connecting the antennas

Connect the	To the
AM loop antenna	AM terminals
FM wire antenna	FM 75Ω COAXIAL terminal

Notes on antenna hookups

- To prevent noise pickup, keep the AM loop antenna away from the receiver and other components.
- Be sure to fully extend the FM wire antenna.
- After connecting the FM wire antenna, keep it as horizontal as possible.

💡 If you have poor FM reception

Use a 75-ohm coaxial cable (not supplied) to connect the receiver to an outdoor FM antenna as shown below.

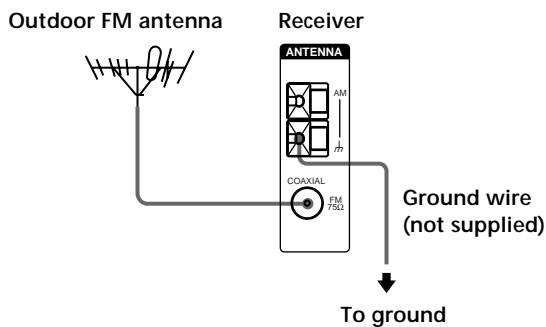

Important

If you connect the receiver to an outdoor antenna, ground it against lightning. To prevent a gas explosion, do not connect the ground wire to a gas pipe.

Note

Do not use the SIGNAL GND terminal for grounding the receiver.

Audio Component Hookups

STR-DE925

Hooking Up the Components

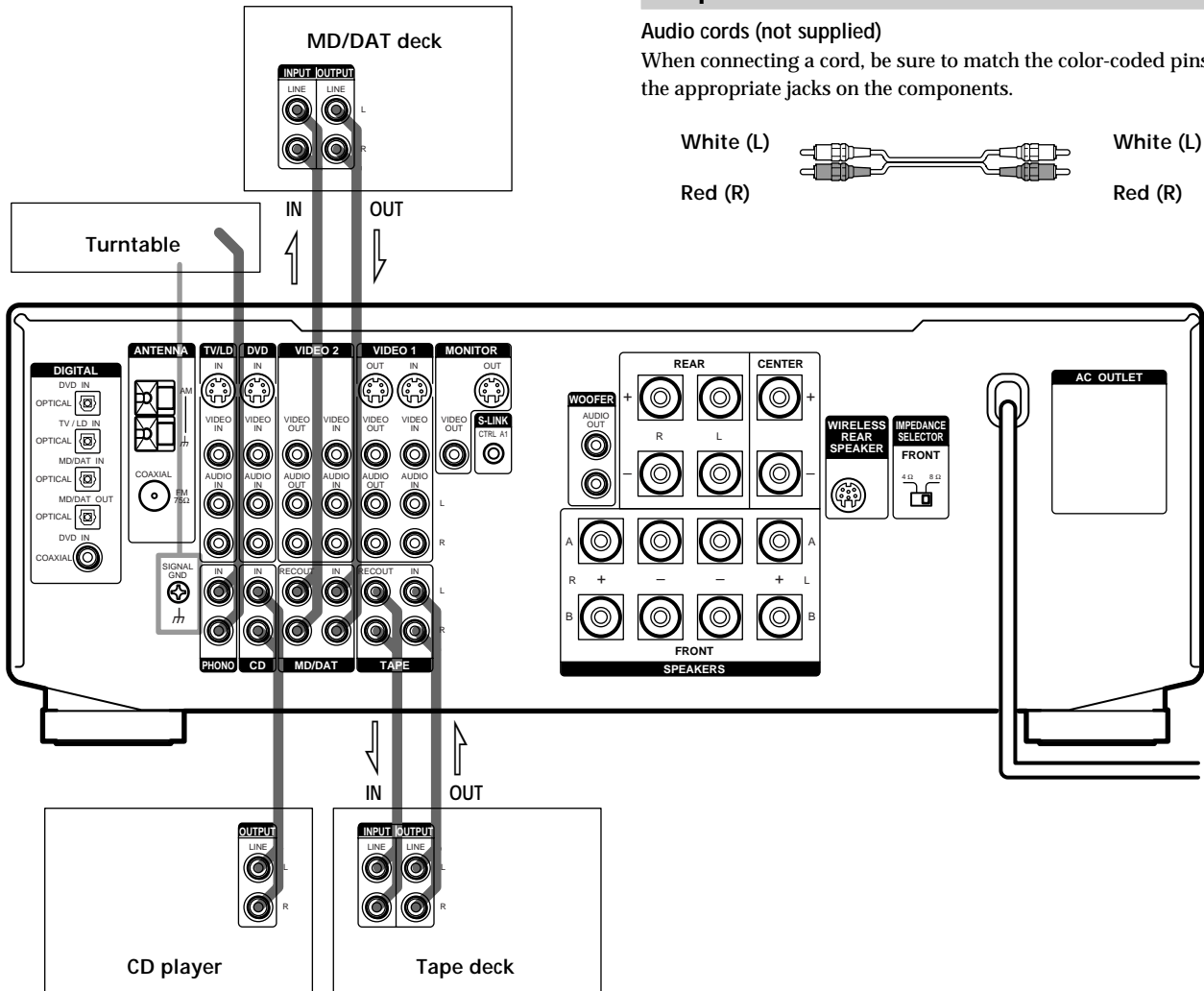

Required cords

Audio cords (not supplied)

When connecting a cord, be sure to match the color-coded pins to the appropriate jacks on the components.

White (L) White (L)
Red (R) Red (R)

Jacks for connecting audio components

Connect a	To the
Turntable	PHONO jacks
CD player	CD jacks
Tape deck	TAPE jacks
MD deck or DAT deck	MD/DAT jacks

Note on audio component hookups

If your turntable has a ground wire, connect it to the SIGNAL GND terminal on the receiver.

STR-DE825

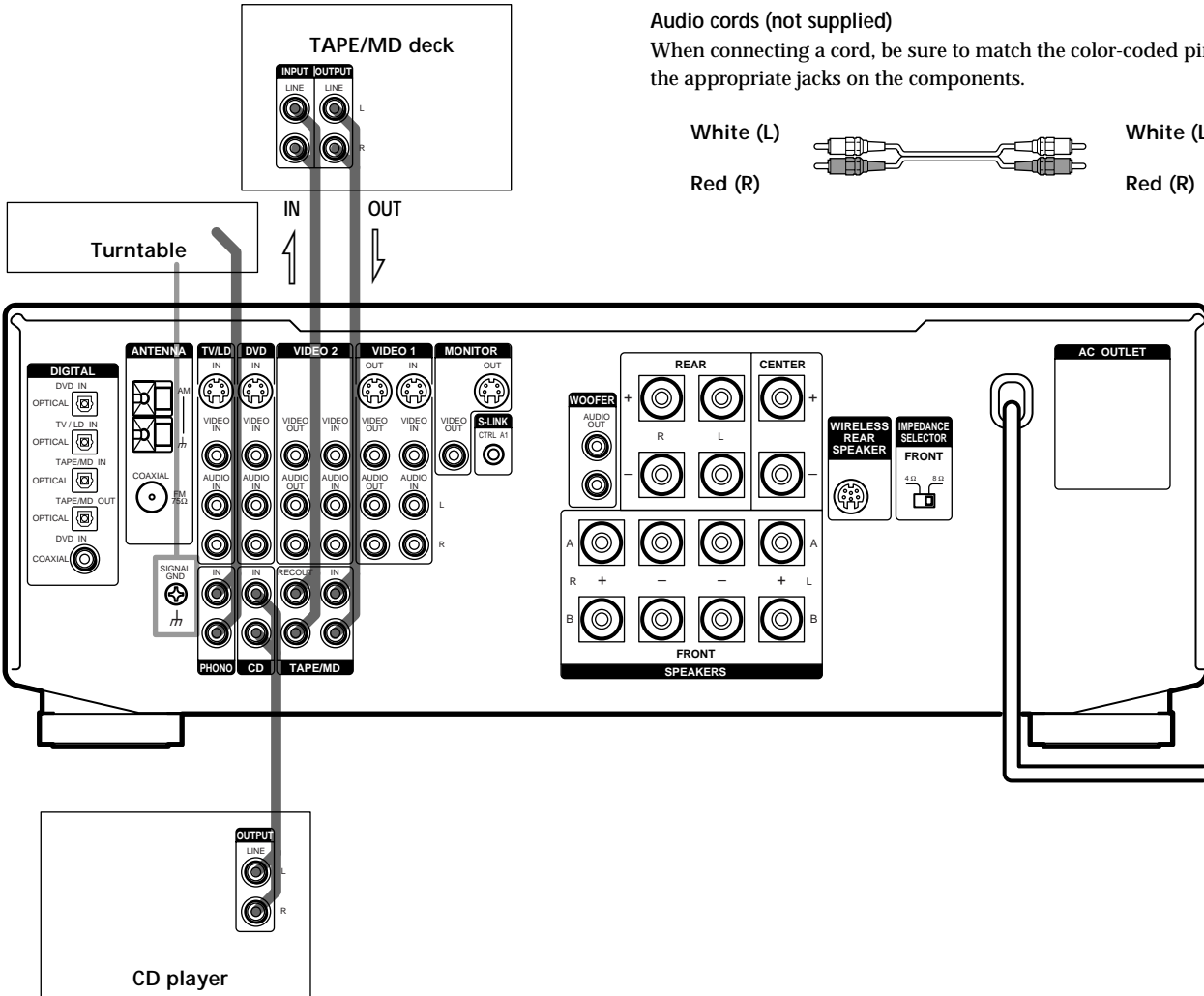

Required cords

Audio cords (not supplied)
When connecting a cord, be sure to match the color-coded pins to the appropriate jacks on the components.



Jacks for connecting audio components

Connect a	To the
Turntable	PHONO jacks
CD player	CD jacks
Tape deck or MD deck	TAPE/MD jacks

Note on audio component hookups

If your turntable has a ground wire, connect it to the SIGNAL GND \hbar terminal on the receiver.

Video Component Hookups

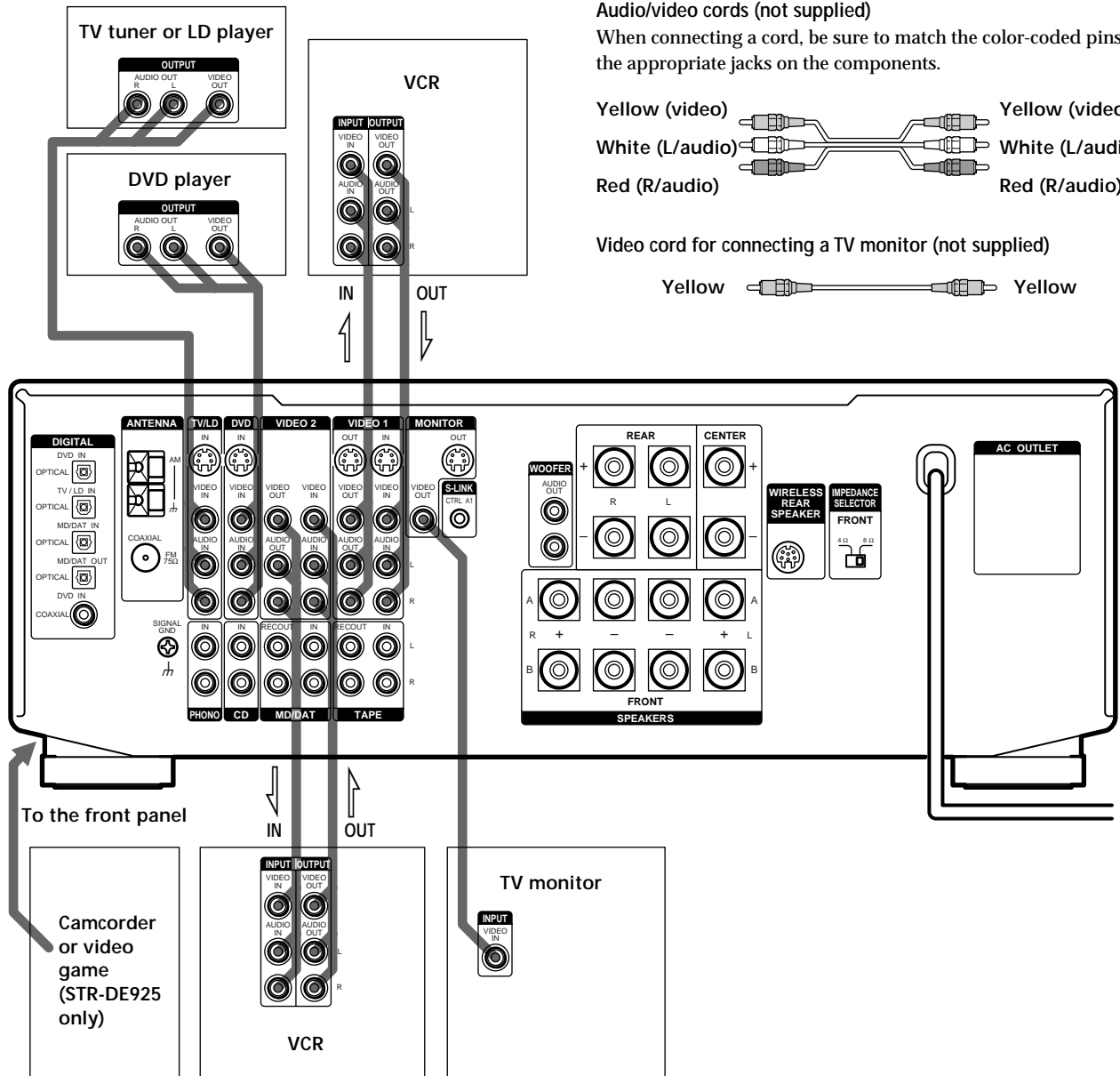

Required cords

Audio/video cords (not supplied)
When connecting a cord, be sure to match the color-coded pins to the appropriate jacks on the components.

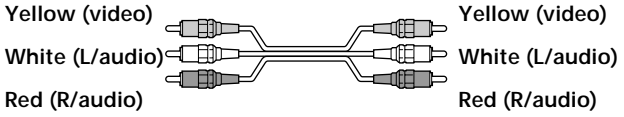

Video cord for connecting a TV monitor (not supplied)



Jacks for connecting dvd video components

Connect a	To the
TV tuner or LD player	TV/LD jacks
VCR	VIDEO 1 jacks
Additional VCR	VIDEO 2 jacks
DVD player	DVD jacks
TV monitor	MONITOR VIDEO OUT jack
Camcorder or video game	VIDEO 3 INPUT jacks on the front panel (STR-DE925 only)

Note on video component hookups

You can connect your TV's audio output jacks to the TV/LD AUDIO IN jacks on the receiver and apply sound effects to the audio from the TV. In this case, do not connect the TV's video output jack to the TV/LD VIDEO IN jack on the receiver. If you are connecting a separate TV tuner, connect both the audio and video output jacks to the receiver as shown above.

Digital Component Hookups

Connect the digital output jacks of your DVD player and TV tuner (etc.) to the receiver's digital input jacks to bring the multi channel surround sound of a movie theater into your home. To enjoy full effect of multi channel surround sound, five speakers (two front speakers, two rear speakers, and a center speaker) and a subwoofer are required. You can also connect an LD player with an RF OUT jack via an RF demodulator, like the Sony MOD-RF1 (not supplied).

Required cords

Optical digital cords (not supplied)

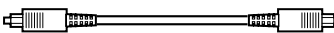

Black  Black

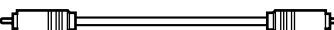
Coaxial digital cord (not supplied)

Black  Black

Audio/video cords (not supplied)

When connecting a cord, be sure to match the color-coded pins to the appropriate jacks on the components.

Yellow (video)  Yellow (video)
 White (L/audio)  White (L/audio)
 Red (R/audio)  Red (R/audio)

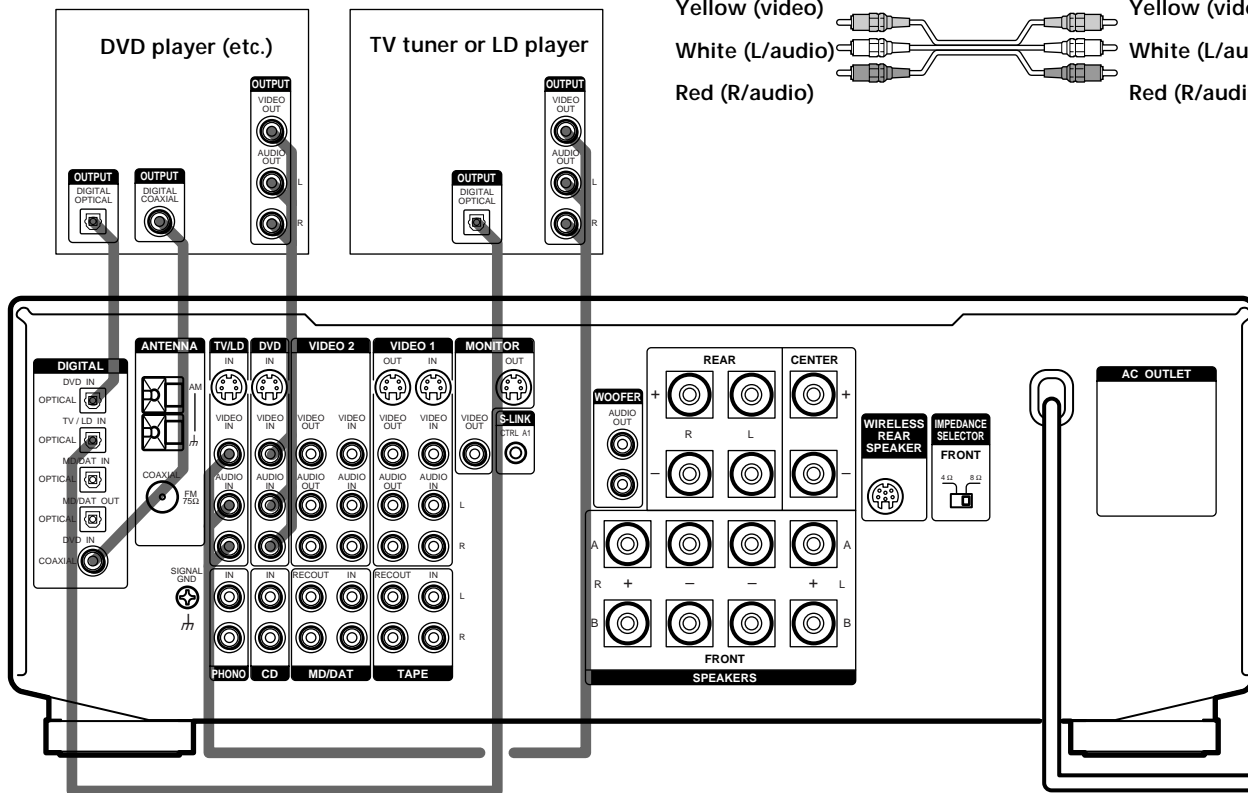

Example of LD player connected via an RF demodulator

Please note that you cannot connect an LD player's AC-3 RF OUT jack directly to this unit's digital input jacks. You must first convert the RF signal to either an optical or coaxial digital signal. Connect the LD player to the RF demodulator, then connect the RF demodulator's optical or coaxial digital output to this unit's OPTICAL TV/LD IN jack. Refer to the instruction manual supplied with your RF Demodulator for details on AC-3 RF hookups.

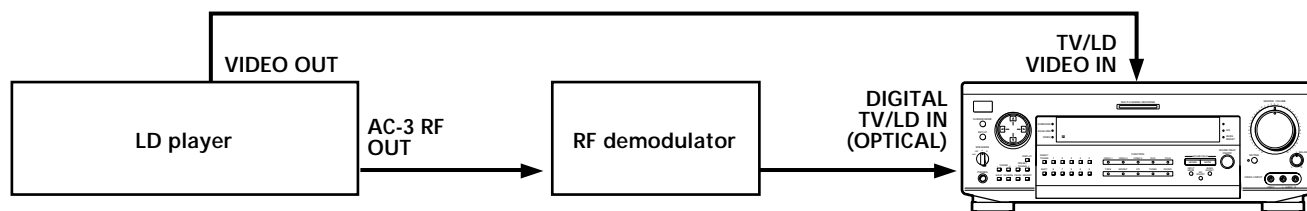

Note

When making connections as shown above, be sure to set INPUT MODE (3 on page 23) manually. This unit may not operate correctly if INPUT MODE is set to "AUTO."

Digital Component Hookups

Connect the digital output jack of your MD or DAT deck to the receiver's digital input jack and connect the digital input jack of your MD or DAT deck to the receiver's digital output jack. These connections allow you to make digital recordings of a CDs played back through your DVD (or LD player) and TV broadcasts.

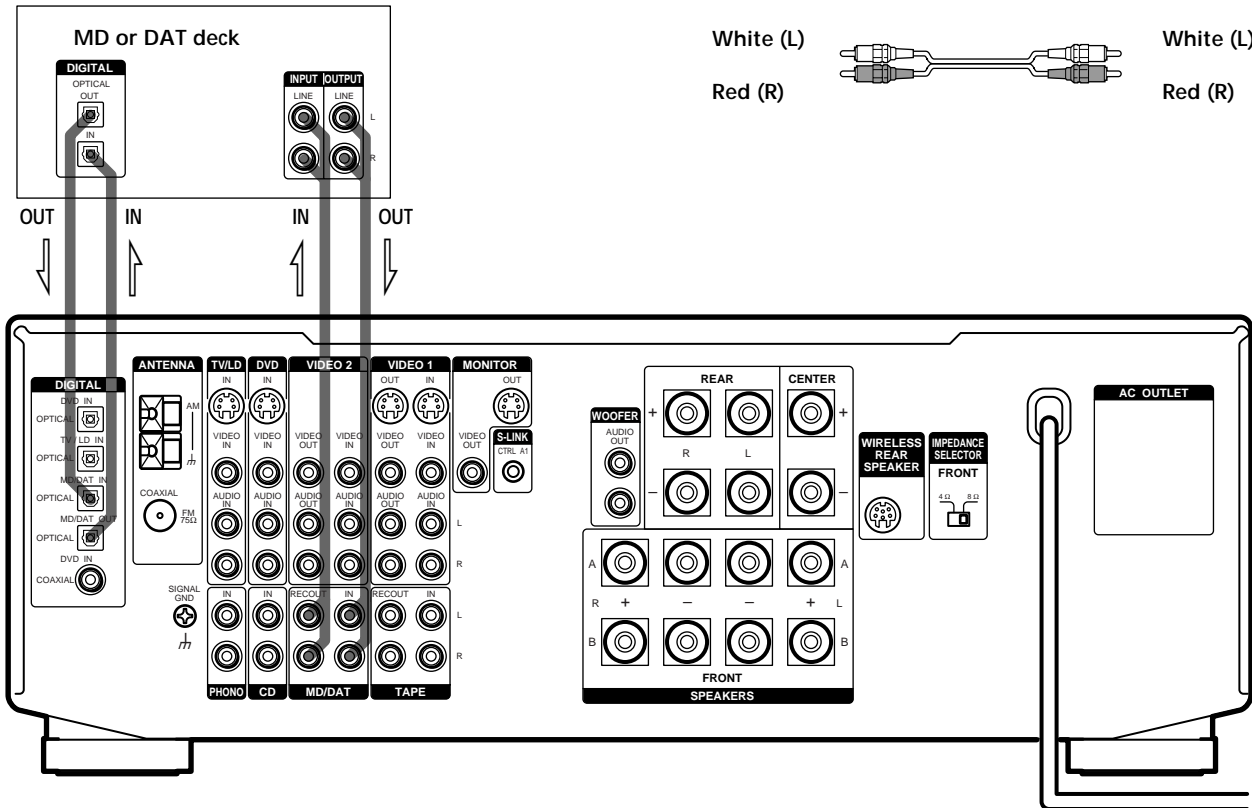

Required cords

Optical digital cords (not supplied)

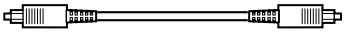
Black  Black

Audio cords (not supplied)

When connecting a cord, be sure to match the color-coded pins to the appropriate jacks on the components.

White (L)  White (L)
Red (R)  Red (R)

Notes

- Please note that you cannot make a digital multi channel surround signal.
- To make a digital recording from your CD player, connect the CD player's digital output directly to the digital input on your MD or DAT deck. Refer to the instructions supplied with your CD player and MD or DAT deck for details.
- This unit is compatible with 32 kHz, 44.1 kHz, and 48 kHz sampling frequencies. It is not compatible with 96 kHz sampling frequencies.
- It is not possible to record analog signals to TAPE and VIDEO with only digital connections. Be sure to make both digital and analog connections to your digital components.

Other Hookups

Required cords

CONTROL A1 connecting cord (not supplied)

Black  Black

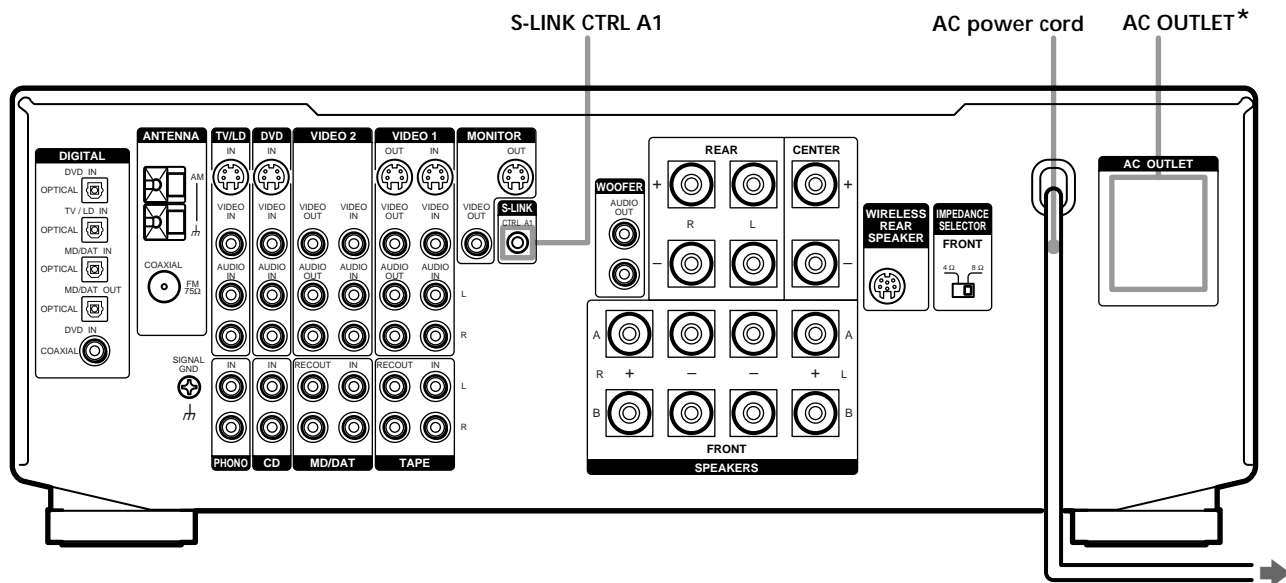

* The configuration, shape, and number of AC outlets on the rear panel varies according to the model and country to which the receiver is shipped.

To a wall outlet

S-LINK CONTROL A1 hookup

- **If you have a S-LINK CONTROL A1-compatible Sony CD player, tape deck, or MD deck**
Use a CONTROL A1 cord (not supplied) to connect the S-LINK CTRL A1 jack on the CD player, tape deck, or MD deck to the S-LINK CTRL A1 jack on the receiver. Refer to the separate manual "CONTROL-A1 Control System" and the operating instructions supplied with your CD player, tape deck, or MD deck for details.

Note

If you make CONTROL A1 connections from the receiver to an MD deck that is also connected to a computer, do not operate the receiver while using the "Sony MD Editor" software. This may cause a malfunction.

- **If you have a Sony CD changer with a COMMAND MODE selector**
If your CD changer's COMMAND MODE selector can be set to CD 1, CD 2, or CD 3, be sure to set the command mode to "CD 1" and connect the changer to the CD jacks on the receiver.
If, however, you have a Sony CD changer with VIDEO OUT jacks, set the command mode to "CD 2" and connect the changer to the VIDEO 2 jacks on the receiver.

Connecting the AC power cord

Before connecting the AC power cord of this receiver to a wall outlet:

- Connect the speaker system to the receiver (see page 13).
- Turn the MASTER VOLUME control to the leftmost position (0).

Connect the AC power cord(s) of your audio/video components to a wall outlet.

If you connect other audio/video components to the AC OUTLET(s) on the receiver, the receiver will supply power to the connected component(s), allowing you to turn the whole system on or off when you turn the receiver on/off.

Caution

Make sure that the total power consumption of the component(s) connected to the receiver's AC OUTLET(s) does not exceed the wattage stated on the rear panel. Do not connect high-wattage electrical home appliances such as electric irons, fans, or TVs to this outlet.

Note

If the AC power cord is disconnected for about one week, the receiver's entire memory will be cleaned and the demonstration will start.

Hooking Up and Setting Up the Speaker System

This chapter describes how to hook up your speaker system to the receiver, how to position each speaker, and how to set up your speakers to enjoy multi channel surround sound.

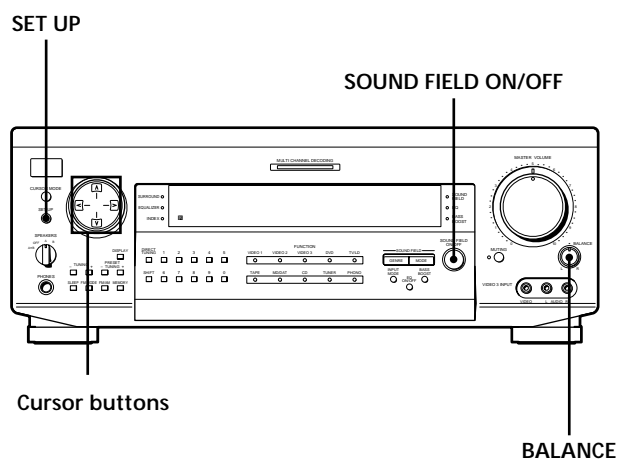

Brief descriptions of buttons and controls used to set up the speaker system

SET UP button: Press repeatedly to display “SPEAKER SETUP” when specifying speaker types or “SPEAKER DISTANCE” when specifying speaker distances.

SOUND FIELD ON/OFF button: Turns the sound field mode on or off.

Cursor buttons (▲/▼/◀/▶): Use to select the parameters and settings after pressing the SET UP button.

BALANCE control: Use to adjust the front speaker balance while outputting a test tone.

Speaker System Hookup

Required cords

Speaker cords (not supplied)

One for each front, rear, and center speaker



Monaural audio cord (not supplied)

One for an active woofer

Black Black

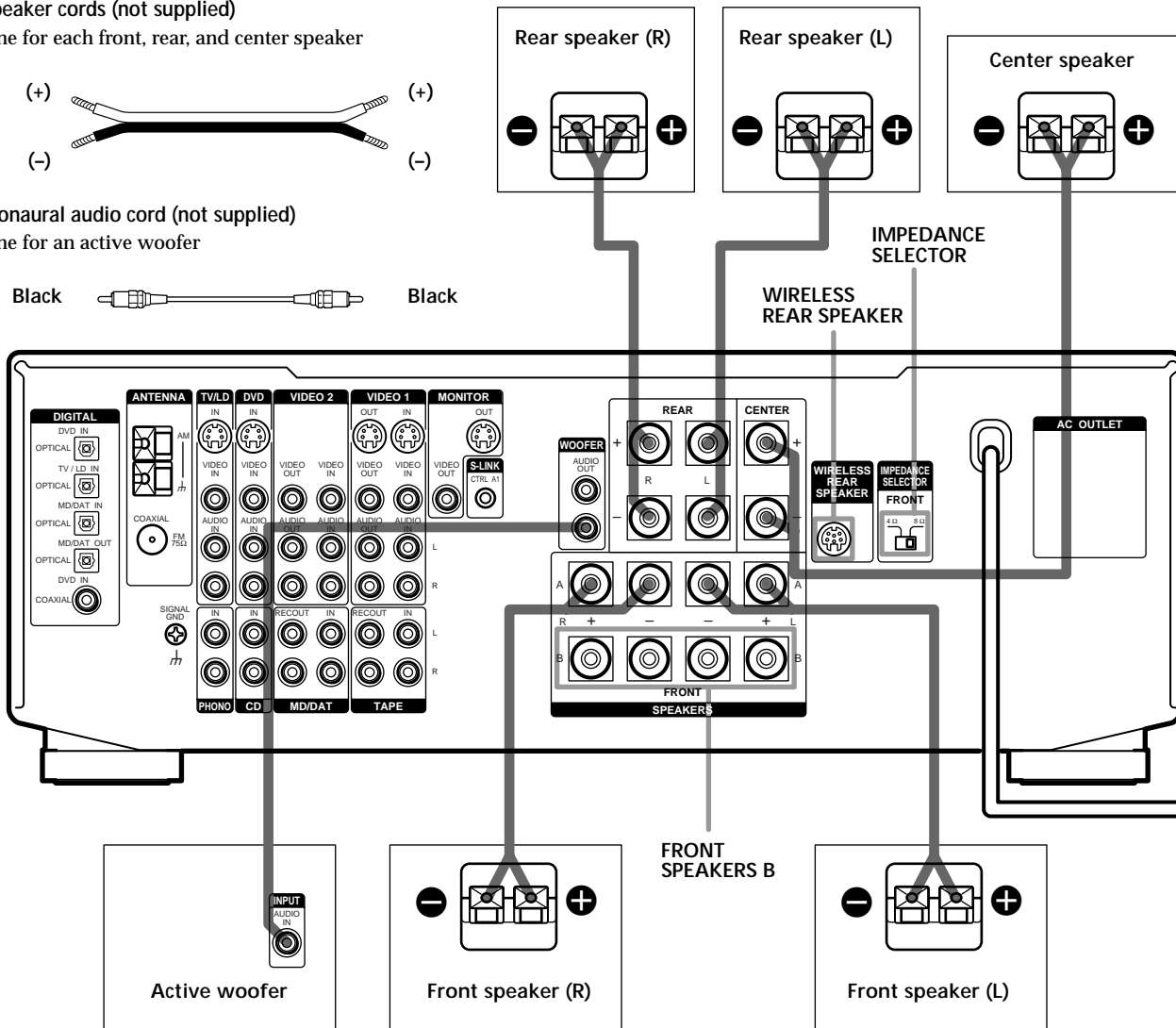

Terminals for connecting the speakers

Connect the	To the
Front speakers (8 or 4* ohm)	SPEAKERS FRONT A terminals
Additional pair of front speakers (8 or 4* ohm)	SPEAKERS FRONT B terminals
Rear speakers (8 ohm)	SPEAKERS REAR terminals
Center speaker (8 ohm)	SPEAKERS CENTER terminals
Active woofer	WOOFER AUDIO OUT jack**
Wireless rear speaker transmitter	WIRELESS REAR SPEAKER jack

* See "Speaker impedance" on the next page.

** You can connect an active woofer to either of the two jacks. The remaining jack can be used to connect a second active woofer.

Notes on speaker system hookup

- Twist the stripped ends of the speaker cords about 2/3 inch (15 mm). Be sure to match the speaker cord to the appropriate terminal on the components: + to + and - to -. If the cords are reversed, the sound will be distorted and will lack bass.
- If you use front speakers with low maximum input rating, adjust the volume carefully to avoid excessive output on the speakers.
- The WIRELESS REAR SPEAKER jack is for use with Sony wireless rear speaker systems only, do not connect any other speaker systems or components to this jack.

Speaker System Hookup

Speaker impedance

To enjoy multi channel surround, connect front, center, and rear speakers with a nominal impedance of 8 ohms or higher, and set the speaker IMPEDANCE SELECTOR to "8Ω." Check the instruction manual supplied with your speakers if you're not sure of their impedance. (This information is usually printed on a label on the back of the speaker.)

You may connect a pair of speakers with a nominal impedance between 4 and 8 ohms to the FRONT SPEAKERS terminals, if you set the IMPEDANCE SELECTOR to "4Ω" but you will not be able to enjoy multi-channel surround sound.

Note

Be sure to connect front speakers with a nominal impedance of 8 ohms or higher if you want to select both sets (A+B) of front speakers (see page 23).

Multi-Channel Surround Setup

For the best possible surround sound all speakers should be the same distance from the listening position (A). (However, this unit lets you to place the center speaker up to 1.5 meters (5 feet) closer (B) and the rear speakers up to 4.5 meters (15 feet) closer (C) to the listening position. The front speakers can be placed from 1.0 to 12.0 meters (3 to 40 feet) from the listening position (A).)

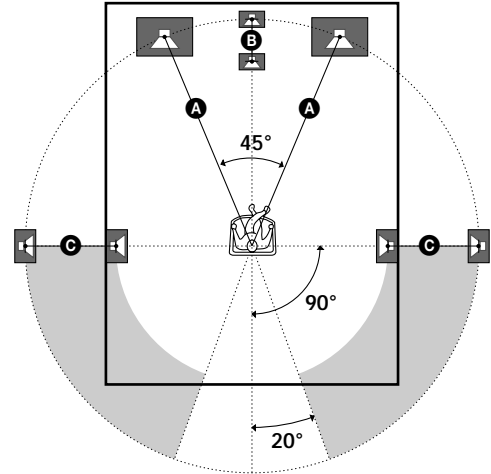

Note

Do not place the center or rear speakers farther away from the listening position than the front speakers.

Depending on the shape of your room (etc.), you may wish to place the rear speakers behind you instead of on the side walls. One advantage of this placement is that you can use a pair of large floor standing speakers matching your front speakers.

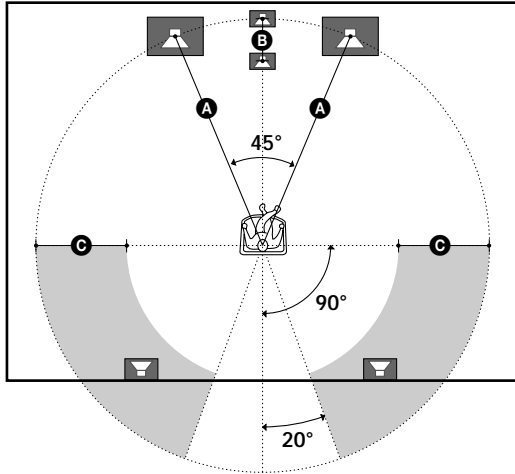

Note

If you place the rear speakers behind you, be sure to check the speaker location setting in the SPEAKER SETUP menu when using sound fields from the VIRTUAL 3D genre (see pages 16 and 28–29 for details).

Specifying the speaker types

- 1 Press I/⏻ to turn on the receiver.
- 2 Press SET UP to display “SPEAKER SETUP”.
- 3 Press the cursor buttons (∧ or ∨) to select the parameter you want to adjust.
- 4 Press the cursor buttons (< or >) to select setting you desire. The setting is entered automatically.
- 5 Repeat steps 3 and 4 until you have set all of the parameters that follow.

■ **Front speaker size (FRONT)**

Initial setting : LARGE

- If you connect large speakers that will effectively reproduce bass frequencies, select “LARGE”. Normally, select “LARGE”.
- If the sound is distorted, or you feel a lack of surround effects when using multi-channel surround sound, select “SMALL” to activate the bass redirection circuitry and output the front channel bass frequencies from the sub woofer.
- When the front speaker is set to “SMALL”, the center and rear speakers are also automatically set to “SMALL” (unless previously set to “NO”).

■ **Center speaker size (CENTER)**

Initial setting : LARGE

- If you connect large speakers that will effectively reproduce bass frequencies, select “LARGE”. Normally, select “LARGE”. However, if the front speakers are set to “SMALL”, you cannot set the center speaker to “LARGE”.
- If the sound is distorted, or you feel a lack of surround effects when using multi-channel surround sound, select “SMALL” to activate the bass redirection circuitry and output the center channel bass frequencies from the front speakers (if set to “LARGE”) or sub woofer.*¹
- If you do not connect the center speaker, select “NO”. The sound of the center channel will be output from the front speakers.*²

■ **Rear speaker size (REAR)**

Initial setting : LARGE

- If you connect large speakers that will effectively reproduce bass frequencies, select “LARGE”. Normally, select “LARGE”. However, if the front speakers are set to “SMALL”, you cannot set the rear speakers to “LARGE”.
- If the sound is distorted, or you feel a lack of surround effects when using multi-channel surround sound, select “SMALL” to activate the bass redirection circuitry and output the rear channel bass frequencies from the sub woofer or other “LARGE” speakers.
- If you do not connect rear speakers, select “NO”.*³

💡 *1~*3 correspond to the following Dolby Pro Logic modes

- *¹ NORMAL
- *² PHANTOM
- *³ 3 STEREO

Multi-Channel Surround Setup

💡 About speaker sizes (LARGE and SMALL)

Internally, the LARGE and SMALL settings for each speaker determine whether or not the internal sound processor will cut the bass signal from that channel. When the bass is cut from a channel, the bass redirection circuitry sends the corresponding bass frequencies to the sub woofer or other “LARGE” speaker. However, since bass sounds have a certain amount of directionality it best not to cut them, if possible. Therefore, even when using small speakers, you can set them to “LARGE” if you want to output the bass frequencies from that speaker. On the other hand, if you are using a large speaker, but prefer not to have bass frequencies output from that speaker, set it to “SMALL”.

If the overall sound level is lower than you prefer, set all speakers to “LARGE”. If there is not enough bass, you can use the equalizer to boost the bass levels. To adjust the equalizer, see page 34.

■ Rear speaker position (REAR PL.)*

Initial setting : BEHIND

This parameter lets you specify the location of your rear speakers for proper implementation of the Digital Cinema Sound surround modes in the VIRTUAL 3D genre. Refer to the illustration below.

- Select “SIDE” if the location of your rear speakers corresponds to section **A**.
- Select “MIDDLE” if the location of your rear speakers corresponds to section **B**.
- Select “BEHIND” if the location of your rear speakers corresponds to section **C**.

This setting only effects the surround modes in the VIRTUAL 3D genre.

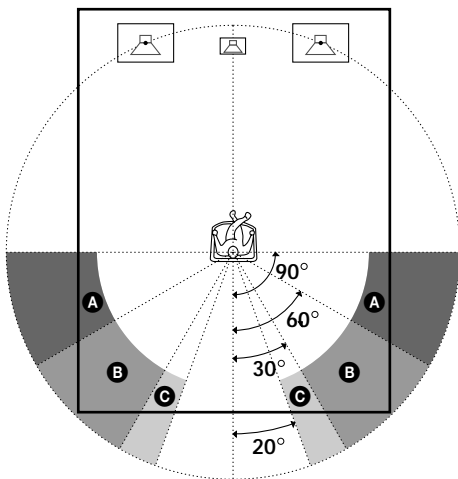

■ Rear speaker height (REAR HGT.)*

Initial setting : LOW

This parameter lets you specify the height of your rear speakers for proper implementation of the Digital Cinema Sound surround modes in the VIRTUAL 3D genre. Refer to the illustration below.

- Select “LOW” if the location of your rear speakers corresponds to section **A**.
- Select “HIGH” if the location of your rear speakers corresponds to section **B**.

This setting only effects the surround modes in the VIRTUAL 3D genre.

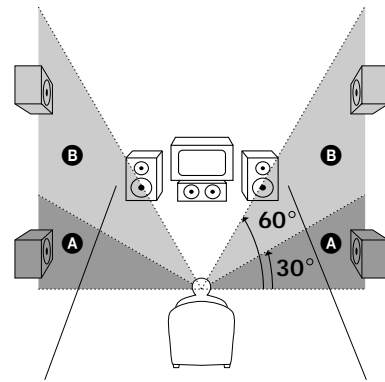

* These parameters are not available when “Rear speaker size (REAR)” is set to “NO”.

💡 About the rear speaker position (SIDE, MIDDLE, and BEHIND)

This setting is designed specifically for implementation of the Digital Cinema Sound modes in the VIRTUAL 3D genre. With the Digital Cinema Sound modes, speaker position is not as critical as other modes. All of the modes in the VIRTUAL 3D genre were designed under the premise that the rear speaker would be located behind the listening position, but presentation remains fairly consistent even with the rear speakers positioned at a rather wide angle. However, if the speakers are pointing toward the listener from the immediate left and right of the listening position, the VIRTUAL 3D modes will not be effective unless the rear speaker position parameter is set to “SIDE”. Nevertheless, each listening environment has many variables, like wall reflections, and you may obtain better results using “BEHIND” or “MIDDLE” if your speakers are located high above the listening position, even if they are to the immediate left and right.

Therefore, although it may result in a setting contrary to the “Rear speaker position” explanation, we recommend that you playback multi channel surround encoded software and listen to the effect each setting has on your listening environment. Choose the setting that provides a good sense of spaciousness and that best succeeds in forming a cohesive space between the surround sound from the rear speakers and the sound of the front speakers. If you are not sure which sounds best, select “BEHIND” and then use the speaker distance parameter and speaker level adjustments to obtain proper balance.

■ Sub woofer selection (WOOFER)

Initial setting : YES

- If you connect a sub woofer, select “YES”.
- If you do not connect a sub woofer, select “NO”. This activates the Dolby Digital (AC-3) bass redirection circuitry and outputs the LFE signals from other speakers.
- In order to take full advantage of the Dolby Digital (AC-3) bass redirection circuitry, we recommend setting the sub woofer’s cut off frequency as high as possible.

Specifying the speaker distances

- 1 Press SET UP to display “SPEAKER DISTANCE”.
- 2 Press the cursor buttons (∧ or ∨) to select the parameter you want to adjust.
- 3 Press the cursor buttons (< or >) to select setting you desire. The setting is entered automatically.
- 4 Repeat steps 2 and 3 until you have set all of the parameters described below.
- 5 Press SET UP to exit the set up mode.

■ Front speaker distance (FRONT)

Initial setting : 5.0 meter

Set the distance from your listening position to the front (left or right) speaker (A on page 14).

- Front speaker distance can be set in 0.1 meter (1 foot) steps from 1.0 to 12.0 meters (3 to 40 feet).
- If both speakers are not placed an equal distance from your listening position, set the distance to the closest speaker.

■ Center speaker distance (CENTER)

Initial setting : 5.0 meter

Set the distance from your listening position to the center speaker.

- Center speaker distance can be set in 0.1 meter (1 foot) steps from a distance equal to the front speaker distance (A on page 14) to a distance 1.5 meters (5 feet) closer to your listening position (B on page 14).
- Do not place the center speaker farther away from your listening position than the front speakers.

■ Rear speaker distance (REAR)

Initial setting : 3.5 meter

Set the distance from your listening position to the rear (left or right) speaker.

- Rear speaker distance can be set in 0.1 meter (1 foot) steps from a distance equal to the front speaker distance (A on page 14) to a distance 4.5 meters (15 feet) closer to your listening position (C on page 14).
- Do not place the rear speakers farther away from your listening position than the front speakers.
- If both speakers are not placed an equal distance from your listening position, set the distance to the closest speaker.

💡 About speaker distances

This unit allows you to input the speaker position in terms of distance. However, it is not possible to set the center speaker farther away than the front speakers. Also, the center speaker can not be set more than 1.5 meters (5 feet) closer than the front speakers.

Likewise, the rear speakers can not be set farther away from the listening position than the front speakers. And they can be no more than 4.5 meters (15 feet) closer.

This is because incorrect speaker placement is not conducive to the enjoyment of surround sound.

Please note that, setting the speaker distance closer than the actual location of the speakers will cause a delay in the output of the sound from that speaker. In other words, the speaker will sound like it is farther away.

For example, setting the center speaker distance 1~2 m (3~6 feet) closer than the actual speaker position will create a fairly realistic sensation of being “inside” the screen. If you cannot obtain a satisfactory surround effect because the rear speakers are too close, setting the rear speaker distance closer (shorter) than the actual distance will create a larger soundstage.

Adjusting these parameter while listening to the sound often results in much better surround sound. Give it a try!

■ Distance unit (DISTANCE)

Initial setting : METER

Lets you select either feet or meters as the unit of measure for setting distances. 1 foot corresponds to a 1 ms difference.

Adjusting the speaker volume

Use the remote while seated in your listening position to adjust the volume of each speaker.

Note

This unit incorporates a new test tone with a frequency centered at 800 Hz for easier speaker volume adjustment.

- 1 Press **I/⏻** to turn on the receiver.
- 2 Press **TEST TONE** on the supplied remote.
You will hear the test tone from each speaker in sequence.
- 3 **Adjust the volume level so that the volume of the test tone from each speaker sounds the same when you are in your main listening position.**
 - To adjust the balance of the front right and front left speakers, use the **BALANCE** control on the front of the receiver.
 - To adjust the balance of the rear right and rear left speakers, use the **REAR BALANCE** parameter in the **SURROUND** cursor mode (see pages 33 and 34). (The rear balance can also be adjusted from the remote.)
 - To adjust the volume level of the center speaker, press the **LEVEL CENTER +/-** buttons on the remote.
 - To adjust the volume level of the rear speakers, press the **LEVEL REAR +/-** buttons on the remote.
- 4 Press **TEST TONE** on the remote again to turn off the test tone.

 You can adjust the volume level of all speakers at the same time

Rotate **MASTER VOLUME** on the main unit or press **MASTER VOLUME +/-** on the remote.

Notes

- The rear balance, center level, and rear level are shown in the display during adjustment.
- Although these adjustments can also be made via the front panel using the **CURSOR MODE** menu **SURROUND** parameters (when the test tone is output, the **CURSOR MODE** switches to the **SURROUND** parameters automatically), we recommend you follow the procedure described above and adjust the speaker levels from your listening position using the remote control.



When setting the volume levels for each speaker

Let's assume that you have matched the sound levels of all the speakers using the test tone. Although this lays the foundation for high quality surround sound, it may be necessary to make further adjustments while listening to playback of actual software. This is because most software contains center and rear channels recorded at slightly lower levels than the two front channels.

When you actually playback software recorded in multi channel surround you will notice that increasing the center and rear speaker levels produces a better blend between the front and center speakers and greater cohesion between the front and rear speakers. Increasing the level of the center speaker about 1 dB, and the rear speakers about 1-2 dB is likely to produce better results.

In other words, in order to create a more cohesive soundstage with balanced dialog, we recommend that you make some adjustments while playing your software. Changes of only 1 dB can make a huge difference in the character of the soundstage.

Before You Use Your Receiver

Before turning on the receiver

Make sure that you have:

- Turned MASTER VOLUME to the leftmost position (0).
- Selected the appropriate front speakers (see “[8] SPEAKERS selector” on page 23).
- Set BALANCE to the center position.

Clearing the receiver’s memory

Before you use your receiver for the first time or when you want to clear the receiver’s memory, do the following.

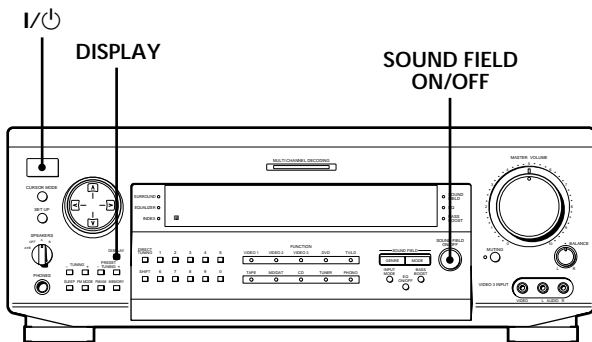

- 1 Turn off the receiver.
- 2 While pressing down DISPLAY and SOUND FIELD ON/OFF, press I/Power to turn on the receiver. The demonstration appears in the display and the items including the following are reset or cleared:
 - All preset stations are reset or cleared.
 - All sound field parameters are reset to their factory settings.
 - All index names (of preset stations and program sources) are cleared.
 - All adjustments made with the SET UP button are reset to their factory settings.
 - The sound field memorized for each program source and preset stations are cleared.

Checking the connections

After connecting all of your components to the receiver, do the following to verify that the connections were made correctly.

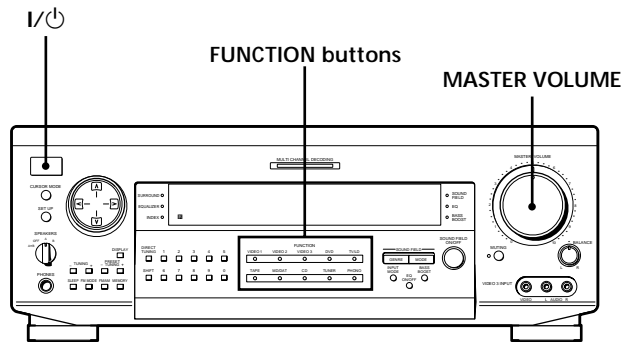

- 1 Press I/Power to turn on the receiver.
- 2 Press a FUNCTION button to select a component (program source) that you connected (e.g., CD player or tape deck).
- 3 Turn on the component and start playing it.
- 4 Rotate MASTER VOLUME to turn up the volume.

If you do not obtain normal sound output after performing this procedure, look for the reason in the following checklist and take the appropriate measures to correct the problem.

There is no sound no matter which component is selected.

- ➔ Check that both the receiver and all components are turned on.
- ➔ Check that the MASTER VOLUME control is not set at 0.
- ➔ Check that the SPEAKERS selector is not set to OFF or to a position for front speakers that are not connected to the receiver (see “[8] SPEAKERS selector” on page 23).
- ➔ Check that all speaker cords are connected correctly.
- ➔ Press the MUTING button to turn off the indicator to the left of the button.

Before You Use Your Receiver

There's no sound from a specific component.

- ➔ Check that the component is connected correctly to the audio input jacks for that component.
- ➔ Check that the cord(s) used for the connection is (are) fully inserted into the jacks on both the receiver and the component.

No sound is heard from one of the front speakers.

- ➔ Check that the BALANCE control is set at center position (see "[6] BALANCE control" on page 23).
- ➔ Connect a pair of headphones to the PHONES jack and set the SPEAKERS selector to OFF to verify that sound is output from the headphones (see "[8] SPEAKERS selector" and "PHONES jack" on page 23).

If only one channel is output from the headphones, the component may not be connected to the receiver correctly. Check that all the cords are fully inserted into the jacks on both the receiver and the component.

If both channels are output from the headphones, the front speaker may not be connected to the receiver correctly. Check the connection of the front speaker which is not outputting any sound.

If you encounter a problem that is not included above, see "Troubleshooting" on page 45.

Location of Parts and Basic Operations

This chapter provides information about the locations and functions of the buttons and controls on the front panel. It also explains basic operations.

Front Panel Parts Description

1 I/⏻ switch

Press to turn the receiver on and off.

- Before you turn on the receiver, make sure that you have turned the MASTER VOLUME control to the leftmost position to avoid damaging you speakers.

2 FUNCTION buttons

Press one of the buttons to select the component you want to use.

To select	Press
VCR	VIDEO 1 or VIDEO 2
Camcorder or video game	VIDEO 3 (STR-DE925 only)
TV tuner or LD player	TV/LD
DVD player	DVD
Tape or MD deck Tape deck	TAPE/MD (STR-DE825) TAPE (STR-DE925)
MD or DAT deck	MD/DAT (STR-DE925 only)
CD player	CD
Built in tuner	TUNER
Turntable	PHONO

After selecting the component, turn on the component you selected and play the program source.

- After selecting VCR, camcorder, video game, DVD player, or LD player, turn on the TV and set the TV's video input.
- When using digital inputs, there may be up to 6 seconds of silence when switching functions or inserting new discs.

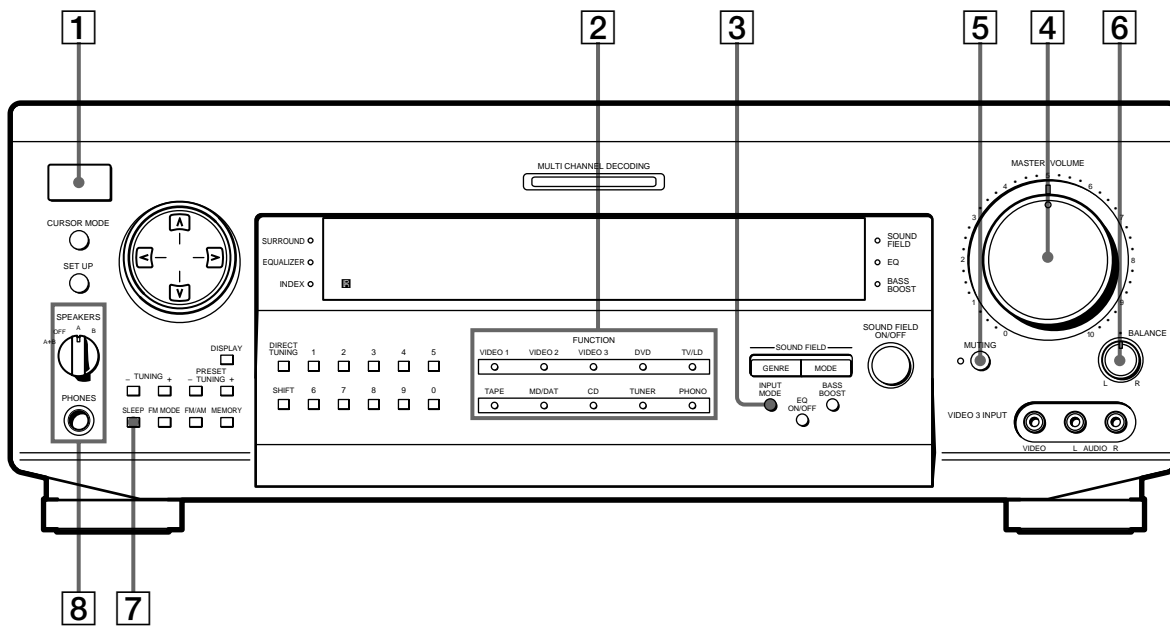

3 INPUT MODE button

Press to select the input mode for your digital components (DVD, TV/LD, and MD/DAT (STR-DE925) or TAPE/MD (STR-DE825)). Each press switches the input mode of the currently selected component.

Select	To
AUTO	Give priority to digital signals when there are both digital and analog connections. If there are no digital signals, analog is selected
ANALOG	Specify the analog audio signals input to the AUDIO IN (L and R) jacks
DIGITAL (OPTICAL)	Specify the digital audio signals input to the DIGITAL OPTICAL input jacks
DIGITAL (COAXIAL)	Specify the digital audio signals input to the DIGITAL COAXIAL input jack (DVD only)

4 MASTER VOLUME control

After turning on the component you selected, rotate to adjust the volume.

5 MUTING button

Press to mute the sound. The indicator to the left of the button lights up when the sound is muted.

6 BALANCE control

Rotate to adjust the balance of the front speakers.

7 SLEEP button

Press to select the time after which the receiver turns off automatically (see page 43).

8 SPEAKERS selector

Set according to the front speakers you want to drive.

Set to	To select
A	The speakers connected to the FRONT SPEAKERS A terminals
B	The speakers connected to the FRONT SPEAKERS B terminals
A+B*	The speakers connected to both the FRONT SPEAKERS A and B terminals (parallel connection)
OFF	No front speaker output

* Do not set to A+B when a sound field is turned on.

PHONES jack

Connects headphones.

- To use the headphones, set the SPEAKERS selector to OFF to output sound to the headphones.
- When the sound field is ON, setting the SPEAKERS selector to OFF will automatically present a two channel downmix from the headphones.

Front Panel Parts Description

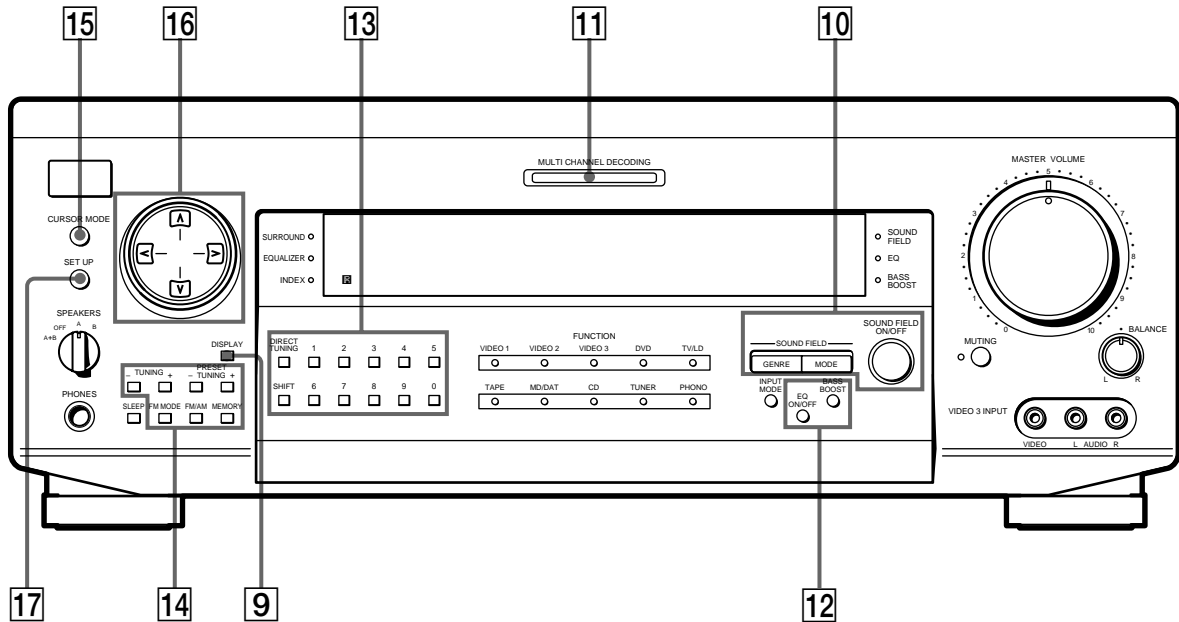

9 DISPLAY button

Press repeatedly to change the information on the display window as follows:

Index name of the component or the preset station*

FUNCTION button indication or frequency**

Sound field applied to the program source

* Index name appears only when you have assigned one to the component or preset station (see page 42). Index name does not appear when only blank spaces have been entered, or it is the same as the function button.

** Frequency appears only when the tuner is selected.

10 Use the following buttons to enjoy surround sound. For details, see “Enjoying Surround Sound” starting from page 26.

GENRE button

Press to select the sound field group you want.

MODE button

Press to select a sound field from the group you selected.

SOUND FIELD ON/OFF button

Press to turn the sound field on or off.

11 MULTI CHANNEL DECODING indicator

This indicator lights when the sound field is on and the unit is decoding signals recorded in a multi channel format.

12 BASS BOOST button

Press to increase the bass of the front speakers. The BASS BOOST indicator lights up when the function is turned on.

EQ ON/OFF button

Press to turn the equalizer on or off. The EQ indicator lights when the equalizer is turned on.

When you adjust the equalizer using the CURSOR MODE menu EQUALIZER parameters (page 34) the settings are stored automatically and can be reproduced whenever you turn on the equalizer.

💡 When you want to enjoy high quality sound

Do the following to bypass the sound field, tone effect, and the bass booster circuits.

- 1 Press BASS BOOST to turn off the BASS BOOST indicator.
- 2 Press EQ ON/OFF to turn off the EQ indicator.
- 3 Press SOUND FIELD ON/OFF to turn off the SOUND FIELD indicator.

The result will be a sound that is highly faithful to the program source.

- 13** The following buttons operate the built-in tuner. For details, see “Receiving Broadcasts” starting from page 37.

DIRECT TUNING button

Enables Direct Tuning (see page 38).

SHIFT button

Selects a memory page for preset stations.

Numeric buttons (1 to 0)

Inputs the numeric value.

- 14** The following buttons operate the built-in tuner. For details, see “Receiving Broadcasts” starting from page 37.

TUNING +/- buttons

Scans all the available radio stations.

PRESET TUNING +/- buttons

Scans all preset stations.

FM MODE button

If “STEREO” flashes in the display and the FM stereo reception is poor, press this button. You will not have the stereo effect but the sound is improved.

FM/AM button

Selects the FM or AM band.

MEMORY button

Press to memorize a preset station.

- 15** **CURSOR MODE button**

Press this button repeatedly to select any of the following three cursor modes. The indicator for the selected cursor mode lights up to the left of the display window. The indicator turns off when you press the SET UP button.

When cursor mode is	You can
SURROUND	Change the various surround parameters (effect level, wall type, etc.), adjust the volume and balance of the rear speakers, and adjust the volume of the center speaker and subwoofer (page 33)
EQUALIZER	Adjust the equalization (bass/mid/treble) of the front, center and rear speakers (page 34). Press the EQ ON/OFF button to activate the equalizer.
INDEX	Enter an index name for preset stations and program sources (page 42)

- 16** **Cursor buttons (^/∨/</>)**

After pressing the CURSOR MODE or SET UP button, use these buttons to make specific settings (see pages 15, 17, 33, 34, and 44).

- 17** **SET UP button**

Press this button repeatedly to select any of the following three indications. The selected indication appears in the display and you will be able to make various settings using the cursor buttons.

When you display	You can
SPEAKER SETUP	Specify the front, center, rear speaker sizes, the rear speaker position, and whether or not you are using a subwoofer (page 15)
SPEAKER DISTANCE	Specify the front, center, and rear speaker distances and the unit of measurement (page 17)
OTHER	Set the display to one of four brightness levels (page 44)

Enjoying Surround Sound

This chapter describes how to set up the receiver to enjoy surround sound. You can enjoy multi channel surround when playing back software encoded with Dolby Digital or DTS (STR-DE925 only).

You can take advantage of surround sound simply by selecting one of the receiver's pre-programmed sound modes. They bring the exciting and powerful sound of movie theaters and concert halls into your home. You can also customize the sound modes to obtain the sound you desire by changing the various surround parameters. The sound modes are divided by type into four basic groups called "genres". The following is a basic explanation of each genre. For information about the sound modes available in each genre, see pages 28~30.

CINEMA

The sound modes in this genre are designed for use when playing back movie software (DVD, LD, etc.) encoded with multi channel surround sound or Dolby Pro Logic. In addition to decoding the surround sound, this genre also includes sound modes that provide the reflections and reverberation typically found in movie theaters. The sound modes in this genre have little effect on two-channel stereo sources (CD, MD, etc.).

VIRTUAL 3D

This genre contains compelling applications of the Sony Digital Cinema Sound digital signal processing technology. These sound modes shift the sound away from the actual speaker locations to simulate the presence of several "virtual" speakers. Like the CINEMA genre, this genre is most effective when playing back movie software encoded with multi channel surround sound.

MUSIC etc.

The sound modes in this genre are designed for use with standard audio sources (like CD) and TV broadcasts. These modes add reverberation to the source signal to create powerful soundfields that make you feel as if you were in a concert hall or stadium (etc.). Use the sound modes in this genre with two-channel sources and stereo broadcasts of sports programs or musical concerts.

A.F.D.

This genre contains the "Auto Format Decoding" sound mode which presents the sound exactly as it was encoded, without adding any reverberation (etc.).

To fully enjoy surround sound, you must register the number and location of you speakers. See "Multi-Channel Surround Setup" starting on page 14 to set the speaker parameters before enjoying surround sound.

CURSOR MODE

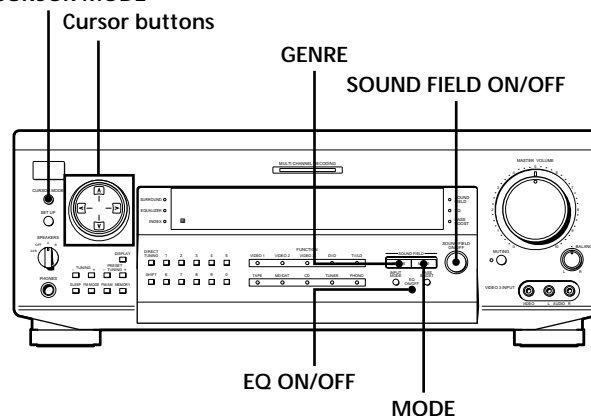

Brief descriptions of buttons used to enjoy surround sound

CURSOR MODE button: Press repeatedly to light up the SURROUND or EQUALIZER indicators to customize a sound field.

Cursor buttons (▲/▼/◀/▶): After pressing the CURSOR MODE button or SET UP button, use these buttons to make the actual setting.

GENRE button: Press to select the desired sound field group (genre).

SOUND FIELD ON/OFF button: Turns the sound field on or off.

MODE button: Press to select the specific sound field from the selected genre.

EQ ON/OFF button: Turns the equalizer on or off.

Selecting a Sound Field

You can enjoy surround sound simply by selecting one of the pre-programmed sound fields according to the program you want to listen to.

1 Press **SOUND FIELD ON/OFF** to turn on the sound field.

The current sound field is indicated in the display.

2 Press **GENRE** repeatedly to select the sound field group (genre), then press **MODE** repeatedly to select the sound field you want.

See the table starting from page 28 for information on each sound field.

 The receiver memorizes the last sound field selected for each program source (Sound Field Link)

Whenever you select a program source, the sound field that was last applied is automatically applied again. For example, if you listen to CD with STADIUM as the sound field, change to a different program source, then return to CD, STADIUM will be applied again. With the tuner, sound fields are memorized separately for AM, FM, and all preset stations.

 You can identify Dolby Surround-encoded software by looking at the packaging

Use discs with the  logo. In order to enjoy Dolby Digital (AC-3) playback you must use discs bearing this logo.

Note

When using sound fields, do not select both speaker systems (A+B) with the SPEAKERS selector.

Selecting a Sound Field

Sound field	Effect	Notes
GENRE : CINEMA		
NORMAL SURROUND	Software with multi channel surround audio signals is played according to the way it was recorded. Software with 2 channel audio signals, is decoded with Dolby Pro Logic to create surround effects.	
CINEMA STUDIO A	Reproduces the sound characteristics of the Sony Pictures Entertainment "Cary Grant Theater" cinema production studio.	This is a standard mode, great for watching most any type of movie.
CINEMA STUDIO B	Reproduces the sound characteristics of the Sony Pictures Entertainment "Kim Novak Theater" cinema production studio.	This mode is ideal for watching science-fiction or action movies with lots of sound effects.
CINEMA STUDIO C	Reproduces the sound characteristics of the Sony Pictures Entertainment scoring stage.	This mode is ideal for watching musicals or classic films where music is featured in the soundtrack.
NIGHT THEATER	Allows you to retain a theater like environment while listening at low volume levels, such as late at night.	
MONO MOVIE	Creates a theater like environment from movies with monaural soundtracks.	
STEREO MOVIE	Creates a theater like environment from movies recorded with stereo soundtracks	

GENRE : VIRTUAL 3D

VIRTUAL MULTI REAR Uses 3D sound imaging to create 3 sets of virtual rear speakers from 1 set of actual rear speakers.

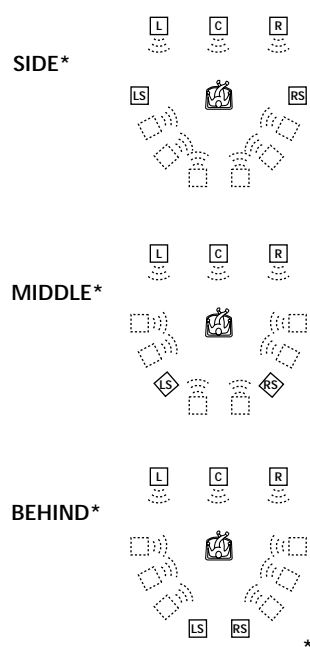

* See page 16

Sound field	Effect	Notes
GENRE : VIRTUAL 3D (continued)		
VIRTUAL MULTI DIMENSION	Uses 3D sound imaging to create an array of virtual rear speakers positioned higher than the listener from a single pair of actual rear speakers. This mode creates 5 sets of virtual speakers surrounding the listener at approximately a 30° angle of elevation.	<p>SIDE*</p>
VIRTUAL THEATER A	Adds the 3D sound imaging of VIRTUAL MULTI DIMENSION to CINEMA STUDIO A. Reproduces the sound characteristics of the “Cary Grant Theater” and creates 5 sets of virtual speakers surrounding the listener (at approximately a 30° angle of elevation) from a single pair of actual rear speakers.	<p>MIDDLE*</p>
VIRTUAL THEATER B	Adds the 3D sound imaging of VIRTUAL MULTI DIMENSION to CINEMA STUDIO B. Reproduces the sound characteristics of the “Kim Novak Theater” and creates 5 sets of virtual speakers surrounding the listener (at approximately a 30° angle of elevation) from a single pair of actual rear speakers.	<p>BEHIND*</p>
VIRTUAL THEATER C	Adds the 3D sound imaging of VIRTUAL MULTI DIMENSION to CINEMA STUDIO C. Reproduces the sound characteristics of the scoring stage and creates 5 sets of virtual speakers surrounding the listener (at approximately a 30° angle of elevation) from a single pair of actual rear speakers.	<p>* See page 16</p>
VIRTUAL ENHANCED A	Uses 3D sound imaging to create 3 sets of virtual rear speakers from the sound of the front speakers without using actual rear speakers.	
VIRTUAL ENHANCED B	Uses 3D sound imaging to create 1 set of virtual rear speakers from the sound of the front speakers without using actual rear speakers.	
VIRTUAL SEMI-MULTI DIMENSION	Uses 3D sound imaging to create virtual rear speakers from the sound of the front speakers without using actual rear speakers. This mode creates 5 sets of virtual speakers surrounding the listener at a 30° angle of elevation.	
VIRTUAL SEMI-THEATER A	Adds the 3D sound imaging of VIRTUAL SEMI-MULTI DIMENSION to CINEMA STUDIO A. Reproduces the sound characteristics of the “Cary Grant Theater” and creates 5 sets of virtual speakers surrounding the listener at a 30° angle of elevation from the sound of the front speakers without using actual rear speakers.	

Selecting a Sound Field

Sound field	Effect	Notes
GENRE : VIRTUAL 3D (continued)		
VIRTUAL SEMI-THEATER B	Adds the 3D sound imaging of VIRTUAL SEMI-MULTI DIMENSION to CINEMA STUDIO B. Reproduces the sound characteristics of the “Kim Novak Theater” and creates 5 sets of virtual speakers surrounding the listener at a 30° angle of elevation from the sound of the front speakers without using actual rear speakers.	
VIRTUAL SEMI-THEATER C	Adds the 3D sound imaging of VIRTUAL SEMI-MULTI DIMENSION to CINEMA STUDIO C. Reproduces the sound characteristics of the scoring stage and creates 5 sets of virtual speakers surrounding the listener at a 30° angle of elevation from the sound of the front speakers without using actual rear speakers.	
GENRE : MUSIC ETC.		
SMALL HALL	Reproduces the acoustics of a small rectangular concert hall.	Ideal for soft acoustic sounds.
LARGE HALL	Reproduces the acoustics of a large rectangular concert hall.	
OPERA HOUSE	Reproduces the acoustics of an opera house.	Ideal for musicals and opera.
JAZZ CLUB	Reproduces the acoustics of a jazz club.	
DISCO/CLUB	Reproduces the acoustics of a discotheque/dance club.	
CHURCH	Reproduces the acoustics of a stone church.	
LIVE HOUSE	Reproduces the acoustics of a 300-seat live house.	Great for rock or pop music.
ARENA	Reproduces the acoustics of a 1000-seat concert hall.	
STADIUM	Reproduces the feeling of a large open-air stadium.	Great for sporting events or electric (amplified) music.
GAME	Obtains maximum audio impact from video game software.	Be sure to set the game machine to stereo mode when using game software with stereo sound capabilities.
GENRE : A.F.D.		
AUTO FORMAT DECODING	Automatically detects the type of audio signal being input (Dolby Digital, DTS, Dolby Pro Logic, or standard 2-channel stereo) and performs the proper decoding if necessary. This mode presents the sound as it was recorded/encoded, without adding any effects.	You can use this mode as a reference. Set the equalizer to OFF while using this mode to hear the source sound exactly as it was recorded.

Note

The effects provided by VIRTUAL THEATER A, B, and C sound fields may cause increased noise in the playback signal.

Understanding the Multi-Channel Surround Displays

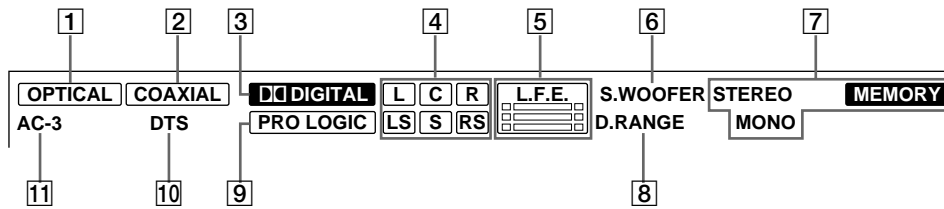

- 1** OPTICAL
Lights up when the source signal is a digital signal being input through the OPTICAL terminal.
- 2** COAXIAL
Lights up when the source signal is a digital signal being input through the COAXIAL terminal.
- 3** DIGITAL
This indicator lights when the sound field is on and the unit is decoding signals recorded in the Dolby Digital (AC-3) format.
- 4** Playback channel indicators
The letters light to indicate the channels being played back.
L: Front Left R: Front Right
C: Center (monaural) LS: Left Surround
RS: Right Surround
S: Surround (monaural or the rear components obtained by Pro Logic processing)
The boxes around the letters light to indicate the speakers used to playback the channels.
See the next page for details regarding the playback channel indicators.
- 5** L.F.E.
The letters "L.F.E." light up when the disc being played contains the LFE (Low Frequency Effect) channel. When the sound of the LFE channel signal is actually being reproduced, the bars underneath the letters lights up to indicate the level. Since the LFE signal is not recorded in all parts of the input signal the bar indication will fluctuate (and may turn off) during playback.
- 6** S.WOOFER
Lights when sub woofer selection is set to "YES" and this unit detects that the disc being played does not contain the LFE channel signal. While this indicator is lit, this unit creates a sub woofer signal based on the low frequency components of the front channels.
- 7** Tuner indicators
These indicators light when using the receiver to tune in radio stations, etc. See pages 37~40 for tuner operations.
- 8** D. RANGE
Lights when dynamic range compression is active. See page 33 and 34 to adjust the dynamic range compression.
- 9** PRO LOGIC
Lights when this unit applies Pro Logic processing to two channel signals in order to output the center and surround channel signals.
- 10** DTS (STR-DE925 only)
Lights up when DTS signals are input.

Notes
 - When playing a DTS format disc, be sure that you have made digital connections and that INPUT MODE is NOT set to ANALOG (see **3** on page 23).
 - You may hear some noise when starting playback from a DTS format LD or CD. This, however, is not a malfunction.
- 11** AC-3
Lights when Dolby Digital (AC-3) signals are input.

Understanding the Multi-Channel Sound Displays

Playback channel display

The display shows which channels are being played back and which speakers are being used. The letters (L, C, R, etc.) light to show the channels being played back. The boxes around the letters light to show which speakers are being used. The display varies depending on the number of speakers connected. See the “Speaker Setup and Playback Channel Display” column in the table below.

This unit also displays the number of channels in the input signal. See the “Input Channel Display” column in the table below.

Although the table below shows almost all of the configurations available from multi channel surround signals, the ones marked “☆” are the most common.

Recording Format (Front/Rear)	Input Channel Display	Speaker Setup and Playback Channel Display			
		All speakers present	Rear speakers absent	Center speaker absent	Rear/center speakers absent
1/0	DOLBY DIGITAL [1/0]	<input checked="" type="checkbox"/> DIGITAL <input type="checkbox"/> C	<input checked="" type="checkbox"/> DIGITAL <input type="checkbox"/> C	<input checked="" type="checkbox"/> DIGITAL <input type="checkbox"/> c <input type="checkbox"/>	<input checked="" type="checkbox"/> DIGITAL <input type="checkbox"/> c <input type="checkbox"/>
	— dts [1/0]	DTS <input type="checkbox"/> C	DTS <input type="checkbox"/> C	DTS <input type="checkbox"/> c <input type="checkbox"/>	DTS <input type="checkbox"/> c <input type="checkbox"/>
2/0*	DOLBY DIGITAL [2/0]	<input type="checkbox"/> L <input type="checkbox"/> R	<input type="checkbox"/> L <input type="checkbox"/> R	<input type="checkbox"/> L <input type="checkbox"/> R	<input type="checkbox"/> L <input type="checkbox"/> R
	— dts [2/0]	DTS <input type="checkbox"/> L <input type="checkbox"/> R	DTS <input type="checkbox"/> L <input type="checkbox"/> R	DTS <input type="checkbox"/> L <input type="checkbox"/> R	DTS <input type="checkbox"/> L <input type="checkbox"/> R
3/0	DOLBY DIGITAL [3/0]	<input checked="" type="checkbox"/> DIGITAL <input type="checkbox"/> L <input type="checkbox"/> C <input type="checkbox"/> R	<input checked="" type="checkbox"/> DIGITAL <input type="checkbox"/> L <input type="checkbox"/> C <input type="checkbox"/> R	<input checked="" type="checkbox"/> DIGITAL <input type="checkbox"/> L <input type="checkbox"/> c <input type="checkbox"/> R	<input checked="" type="checkbox"/> DIGITAL <input type="checkbox"/> L <input type="checkbox"/> c <input type="checkbox"/> R
	— dts [3/0]	DTS <input type="checkbox"/> L <input type="checkbox"/> C <input type="checkbox"/> R	DTS <input type="checkbox"/> L <input type="checkbox"/> C <input type="checkbox"/> R	DTS <input type="checkbox"/> L <input type="checkbox"/> c <input type="checkbox"/> R	DTS <input type="checkbox"/> L <input type="checkbox"/> c <input type="checkbox"/> R
2/1	DOLBY DIGITAL [2/1]	<input checked="" type="checkbox"/> DIGITAL <input type="checkbox"/> L <input type="checkbox"/> R <input type="checkbox"/> S	<input checked="" type="checkbox"/> DIGITAL <input type="checkbox"/> L <input type="checkbox"/> R <input type="checkbox"/> S	<input checked="" type="checkbox"/> DIGITAL <input type="checkbox"/> L <input type="checkbox"/> R <input type="checkbox"/> S	<input checked="" type="checkbox"/> DIGITAL <input type="checkbox"/> L <input type="checkbox"/> R <input type="checkbox"/> S
	— dts [2/1]	DTS <input type="checkbox"/> L <input type="checkbox"/> R <input type="checkbox"/> S	DTS <input type="checkbox"/> L <input type="checkbox"/> R <input type="checkbox"/> S	DTS <input type="checkbox"/> L <input type="checkbox"/> R <input type="checkbox"/> S	DTS <input type="checkbox"/> L <input type="checkbox"/> R <input type="checkbox"/> S
3/1	DOLBY DIGITAL [3/1]	<input checked="" type="checkbox"/> DIGITAL <input type="checkbox"/> L <input type="checkbox"/> C <input type="checkbox"/> R <input type="checkbox"/> S	<input checked="" type="checkbox"/> DIGITAL <input type="checkbox"/> L <input type="checkbox"/> C <input type="checkbox"/> R <input type="checkbox"/> S	<input checked="" type="checkbox"/> DIGITAL <input type="checkbox"/> L <input type="checkbox"/> c <input type="checkbox"/> R <input type="checkbox"/> S	<input checked="" type="checkbox"/> DIGITAL <input type="checkbox"/> L <input type="checkbox"/> c <input type="checkbox"/> R <input type="checkbox"/> S
	— dts [3/1]	DTS <input type="checkbox"/> L <input type="checkbox"/> C <input type="checkbox"/> R <input type="checkbox"/> S	DTS <input type="checkbox"/> L <input type="checkbox"/> C <input type="checkbox"/> R <input type="checkbox"/> S	DTS <input type="checkbox"/> L <input type="checkbox"/> c <input type="checkbox"/> R <input type="checkbox"/> S	DTS <input type="checkbox"/> L <input type="checkbox"/> c <input type="checkbox"/> R <input type="checkbox"/> S
2/2	DOLBY DIGITAL [2/2]	<input checked="" type="checkbox"/> DIGITAL <input type="checkbox"/> L <input type="checkbox"/> R <input type="checkbox"/> LS <input type="checkbox"/> RS	<input checked="" type="checkbox"/> DIGITAL <input type="checkbox"/> L <input type="checkbox"/> R <input type="checkbox"/> LS <input type="checkbox"/> RS	<input checked="" type="checkbox"/> DIGITAL <input type="checkbox"/> L <input type="checkbox"/> R <input type="checkbox"/> LS <input type="checkbox"/> RS	<input checked="" type="checkbox"/> DIGITAL <input type="checkbox"/> L <input type="checkbox"/> R <input type="checkbox"/> LS <input type="checkbox"/> RS
	— dts [2/2]	DTS <input type="checkbox"/> L <input type="checkbox"/> R <input type="checkbox"/> LS <input type="checkbox"/> RS	DTS <input type="checkbox"/> L <input type="checkbox"/> R <input type="checkbox"/> LS <input type="checkbox"/> RS	DTS <input type="checkbox"/> L <input type="checkbox"/> R <input type="checkbox"/> LS <input type="checkbox"/> RS	DTS <input type="checkbox"/> L <input type="checkbox"/> R <input type="checkbox"/> LS <input type="checkbox"/> RS
3/2	☆ DOLBY DIGITAL [3/2]	<input checked="" type="checkbox"/> DIGITAL <input type="checkbox"/> L <input type="checkbox"/> C <input type="checkbox"/> R <input type="checkbox"/> LS <input type="checkbox"/> RS	<input checked="" type="checkbox"/> DIGITAL <input type="checkbox"/> L <input type="checkbox"/> C <input type="checkbox"/> R <input type="checkbox"/> LS <input type="checkbox"/> RS	<input checked="" type="checkbox"/> DIGITAL <input type="checkbox"/> L <input type="checkbox"/> c <input type="checkbox"/> R <input type="checkbox"/> LS <input type="checkbox"/> RS	<input checked="" type="checkbox"/> DIGITAL <input type="checkbox"/> L <input type="checkbox"/> c <input type="checkbox"/> R <input type="checkbox"/> LS <input type="checkbox"/> RS
	☆ dts [3/2]	DTS <input type="checkbox"/> L <input type="checkbox"/> C <input type="checkbox"/> R <input type="checkbox"/> LS <input type="checkbox"/> RS	DTS <input type="checkbox"/> L <input type="checkbox"/> C <input type="checkbox"/> R <input type="checkbox"/> LS <input type="checkbox"/> RS	DTS <input type="checkbox"/> L <input type="checkbox"/> c <input type="checkbox"/> R <input type="checkbox"/> LS <input type="checkbox"/> RS	DTS <input type="checkbox"/> L <input type="checkbox"/> c <input type="checkbox"/> R <input type="checkbox"/> LS <input type="checkbox"/> RS
2/0**	☆ DOLBY DIGITAL [2/0]	<input type="checkbox"/> PRO LOGIC <input type="checkbox"/> L <input type="checkbox"/> C <input type="checkbox"/> R <input type="checkbox"/> S	<input type="checkbox"/> PRO LOGIC <input type="checkbox"/> L <input type="checkbox"/> C <input type="checkbox"/> R <input type="checkbox"/> S	<input type="checkbox"/> PRO LOGIC <input type="checkbox"/> L <input type="checkbox"/> c <input type="checkbox"/> R <input type="checkbox"/> S	<input type="checkbox"/> PRO LOGIC <input type="checkbox"/> L <input type="checkbox"/> c <input type="checkbox"/> R <input type="checkbox"/> S
	☆ dts[2/0]	DTS <input type="checkbox"/> L <input type="checkbox"/> C <input type="checkbox"/> R <input type="checkbox"/> S	DTS <input type="checkbox"/> L <input type="checkbox"/> C <input type="checkbox"/> R <input type="checkbox"/> S	DTS <input type="checkbox"/> L <input type="checkbox"/> c <input type="checkbox"/> R <input type="checkbox"/> S	DTS <input type="checkbox"/> L <input type="checkbox"/> c <input type="checkbox"/> R <input type="checkbox"/> S
	☆ DOLBY PRO LOGIC	<input type="checkbox"/> PRO LOGIC <input type="checkbox"/> L <input type="checkbox"/> C <input type="checkbox"/> R <input type="checkbox"/> S	<input type="checkbox"/> PRO LOGIC <input type="checkbox"/> L <input type="checkbox"/> C <input type="checkbox"/> R <input type="checkbox"/> S	<input type="checkbox"/> PRO LOGIC <input type="checkbox"/> L <input type="checkbox"/> c <input type="checkbox"/> R <input type="checkbox"/> S	<input type="checkbox"/> PRO LOGIC <input type="checkbox"/> L <input type="checkbox"/> c <input type="checkbox"/> R <input type="checkbox"/> S
	☆ STEREO PCM**	<input type="checkbox"/> L <input type="checkbox"/> R	<input type="checkbox"/> L <input type="checkbox"/> R	<input type="checkbox"/> L <input type="checkbox"/> R	<input type="checkbox"/> L <input type="checkbox"/> R

* Without Pro Logic

**When Pro Logic is ON or a sound mode from the CINEMA or VIRTUAL 3D genre is selected.

Customizing Sound Fields

By adjusting the surround parameters and the equalization of the front and center speakers, you can customize the sound fields to suit your particular listening situation.

Once you customize a sound field, the changes are stored in memory indefinitely (unless the receiver is unplugged for about one week). You can change a customized sound field any time by making new adjustments to the parameters.

See the table on page 36 for the parameters available in each sound field.

To get the most from multi channel surround sound

Position your speakers and do the procedures described in “Multi-Channel Surround Setup” starting on page 14 before you customize a sound field.

Adjusting the surround parameters

The SURROUND menu contains parameters that let you customize various aspects of the current sound field. The settings available in this menu are stored individually for each sound field.

- 1** Start playing a program source encoded with multi channel surround sound.
- 2** Press CURSOR MODE repeatedly until the SURROUND indicator lights up.
- 3** Press the cursor buttons (\wedge or \vee) to select the parameter you want to adjust.
- 4** Press the cursor buttons (\leftarrow or \rightarrow) to select setting you desire. The setting is entered automatically.

EFFECT LEVEL (EFFECT)

Initial setting : (depends on sound mode)

This parameter lets you adjust the “presence” of the current digital cinema sound surround effect.

WALL TYPE (WALL)

Initial setting : midpoint

When sound is reflected off soft material, such as a curtain, the high frequency elements are reduced. A hard wall is highly reflective and does not significantly effect the frequency response of the reflected sound. This parameter lets you control the level of the high frequencies to alter the sonic character of your listening environment by simulating a softer (S) or harder (H) wall. The midpoint designates a neutral wall (made of wood).

REVERBERATION (REVERB)

Initial setting : midpoint

Before sound reaches our ears, it is reflected (reverberated) many times between the left and right walls, ceiling, and floor. In a large room, sound takes more time to bounce from one surface to another than in a smaller room. This parameter lets you control the spacing of the early reflections to simulate a sonically larger (L) or smaller (S) room.

- The reverberation can be adjusted ± 8 from S (small, -8) to L (large, +8) in 17 steps.
- The midpoint (0) designates a standard room with no adjustment.

LFE (Low Frequency Effect) MIX LEVEL (LFE MIX)

Initial setting : 0 dB

This parameter lets you attenuate the level of the LFE (Low Frequency Effect) channel output from the sub woofer without effecting the level of the bass frequencies sent to the sub woofer from the front, center or rear channels via the Dolby Digital (AC-3) bass redirection circuitry.

- The level can be adjusted in 1 dB steps from -20 dB to 0 dB (line level). 0 dB outputs the full LFE signal at the mix level determined by the recording engineer.
- Selecting MUTING mutes the sound of the LFE channel from the sub woofer. However, the low frequency sounds of the front, center, or rear speakers are output from the sub woofer according to the settings made for each speaker in the speaker setup (page 15).

DYNAMIC RANGE COMPRESSOR (D. RANGE COMP)

Initial setting : OFF

Lets you compress the dynamic range of the sound track. This may be useful when you want to watch movies at low volumes late at night.

- OFF reproduces the sound track with no compression.
- STD reproduces the sound track with the dynamic range intended by the recording engineer.
- 0.1 ~ 0.9 allow you to compress the dynamic range in small steps to achieve the sound you desire.
- MAX provides a dramatic compression of the dynamic range.

Note

Dynamic range compression is not possible with DTS sources.



About the Dynamic Range Compressor

This parameter allows you to compress the dynamic range of the soundtrack based on the dynamic range information included in the Dolby Digital signal. "STD" is standard compression, but because many sources have only light compression, you may not notice much difference when using 0.1~0.9.

Therefore, we recommend using the "MAX" setting. This greatly compresses the dynamic range and allows you to view movies late at night at low volumes. Unlike analog limiters, the levels are predetermined and provide a very natural compression.

REAR BALANCE (REAR)

Initial setting : center

Lets you adjust the balance between the rear left and right speakers.

- The balance can be adjusted ± 8 dB in 1 dB steps.
- This settings can also be adjusted directly using the supplied remote. See "Adjusting the speaker volume" (page 18).

REAR LEVEL (REAR)

Initial setting : 0 dB

Lets you adjust level of the rear (left and right) speakers.

- The level can be adjusted in 1 dB steps from -10 dB to +10 dB.
- This settings can also be adjusted directly using the supplied remote. See "Adjusting the speaker volume" (page 18).

CENTER LEVEL (CENTER)

Initial setting : 0 dB

Lets you adjust the level of the center speaker.

- The level can be adjusted in 1 dB steps from -10 dB to +10 dB.

SUB WOOFER LEVEL (WOOFER)

Initial setting : 0 dB

Lets you adjust the level of the sub woofer.

- The level can be adjusted in 1 dB steps from -10 dB to +10 dB.

Adjusting the equalizer

The EQUALIZER menu lets you adjust the equalization (low, mid, and high frequencies) of the front and center speakers. The equalizer settings are stored individually for each sound field.

- 1 Start playing a program source encoded with multi channel surround sound.
- 2 Press CURSOR MODE repeatedly until the EQUALIZER indicator lights up.
- 3 Press the cursor buttons (\wedge or \vee) to select the parameter you want to adjust.
- 4 Press the cursor buttons (\leftarrow or \rightarrow) to select setting you desire. The setting is entered automatically.



You can turn off the equalization without erasing it

The equalizer settings are stored separately for each sound field. Press the EQ ON/OFF button to turn the EQ indicator off.

Front speaker bass adjustment (Level/Frequency)

① Use \wedge/\vee to select the level (dB) or frequency (Hz).

② Use $\lt;/\gt$ to adjust.

Repeat until you achieve the sound you desire.

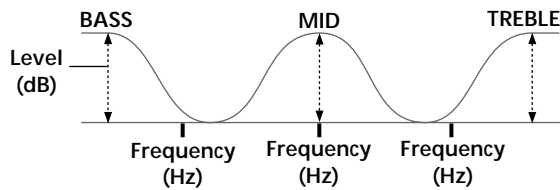

- The level can be adjusted ± 10 dB in 1 dB steps.
- The frequency can be adjusted from 100 Hz to 1.0 kHz in 21 steps.

Front speaker midrange adjustment (Level/Frequency)

Adjust as described in “Front speaker bass adjustment”.

- The level can be adjusted ± 10 dB in 1 dB steps.
- The frequency can be adjusted from 500 Hz to 5.0 kHz in 21 steps.

Front speaker treble adjustment (Level/Frequency)

Adjust as described in “Front speaker bass adjustment”.

- The level can be adjusted ± 10 dB in 1 dB steps.
- The frequency can be adjusted from 1.0 kHz to 10 kHz in 21 steps.

Center speaker bass adjustment (Level/Frequency)

Adjust as described in “Front speaker bass adjustment”.

- The level can be adjusted ± 10 dB in 1 dB steps.
- The frequency can be adjusted from 100 Hz to 1.0 kHz in 21 steps.

Center speaker midrange adjustment (Level/Frequency)

Adjust as described in “Front speaker bass adjustment”.

- The level can be adjusted ± 10 dB in 1 dB steps.
- The frequency can be adjusted from 500 Hz to 5.0 kHz in 21 steps.

Center speaker treble adjustment (Level/Frequency)

Adjust as described in “Front speaker bass adjustment”.

- The level can be adjusted ± 10 dB in 1 dB steps.
- The frequency can be adjusted from 1.0 kHz to 10 kHz in 21 steps.

Rear speaker bass adjustment (Level/Frequency)

Adjust as described in “Front speaker bass adjustment”.

- The level can be adjusted ± 10 dB in 1 dB steps.
- The frequency can be adjusted from 100 Hz to 1.0 kHz in 21 steps.

Rear speaker midrange adjustment (Level/Frequency)

Adjust as described in “Front speaker bass adjustment”.

- The level can be adjusted ± 10 dB in 1 dB steps.
- The frequency can be adjusted from 500 Hz to 5.0 kHz in 21 steps.

Rear speaker treble adjustment (Level/Frequency)

Adjust as described in “Front speaker bass adjustment”.

- The level can be adjusted ± 10 dB in 1 dB steps.
- The frequency can be adjusted from 1.0 kHz to 10 kHz in 21 steps.

Resetting customized sound fields to the factory settings

- 1 If the power is on, press I/power to turn off the power.
- 2 Hold down SOUND FIELD ON/OFF and press I/power . “SURR CLEAR!” appears in the display and all sound fields are reset at once.

Customizing Sound Fields

Adjustable parameters for each sound field

Sound field	GENRE	MODE	EFFECT LEVEL	WALL TYPE	REVERB TIME	LFE MIX	D.RANGE COMP	REAR BAL.	REAR LEVEL	CENTER LEVEL	WOOFER LEVEL	EQ	
Off	—	—				●	●					●	
On	CINEMA	NORMAL SURROUND				●	●	●	●	●	●	●	
		CINEMA STUDIO A	●			●	●	●	●	●	●	●	
		CINEMA STUDIO B	●			●	●	●	●	●	●	●	
		CINEMA STUDIO C	●			●	●	●	●	●	●	●	
		NIGHT THEATER	●	●	●	●	●	●	●	●	●	●	
		MONO MOVIE	●	●	●	●	●	●	●	●	●	●	
		STEREO MOVIE	●	●	●	●	●	●	●	●	●	●	
	VIRTUAL 3D	V. MULTI REAR	●				●	●	●	●	●	●	●
		V. MULTI DIMENSION	●				●	●	●	●	●	●	●
		V. THEATER A	●				●	●	●	●	●	●	●
		V. THEATER B	●				●	●	●	●	●	●	●
		V. THEATER C	●				●	●	●	●	●	●	●
		V. ENHANCED A	●				●	●		●	●	●	
		V. ENHANCED B	●				●	●		●	●	●	
		V. SEMI-M.DIMENSION	●				●	●		●	●	●	
		V. SEMI-THEATER A	●				●	●		●	●	●	
		V. SEMI-THEATER B	●				●	●		●	●	●	
	V. SEMI-THEATER C	●				●	●		●	●	●		
	MUSIC etc.	SMALL HALL	●	●	●	●	●	●	●	●	●	●	●
		LARGE HALL	●	●	●	●	●	●	●	●	●	●	●
		OPERA HOUSE	●	●	●	●	●	●	●	●	●	●	●
JAZZ CLUB		●	●	●	●	●	●	●	●	●	●	●	
DISCO/CLUB		●	●	●	●	●	●	●	●	●	●	●	
CHURCH		●	●	●	●	●	●	●	●	●	●	●	
LIVE HOUSE		●	●	●	●	●	●	●	●	●	●	●	
ARENA		●	●	●	●	●	●	●	●	●	●	●	
STADIUM		●	●	●	●	●	●	●	●	●	●	●	
GAME		●	●	●	●	●	●	●	●	●	●	●	
A.F.D.	AUTO FORMAT DECODE					●	●	●	●	●	●		

Receiving Broadcasts

This chapter describes how to receive FM or AM broadcasts and how to preset selected stations.

You can tune in stations on this receiver in the following ways:

Direct Tuning

You can enter a frequency of the station you want directly by using the numeric buttons (see page 38).

Automatic Tuning

If you don't know the frequency of the station you want, you can let the receiver scan all available stations in your area (see page 39).

Preset Tuning

After you have tuned in stations using Direct Tuning or Automatic Tuning, you can preset them to the receiver (see page 39). Then you can tune in any of the stations directly by entering its 2-character code (see page 40). Up to 30 FM or AM stations can be preset. The receiver will also scan all the stations that you have preset (see page 40).

Before you begin, make sure you have:

- Connected an FM and AM antenna to the receiver (see page 5).
- Selected the appropriate speaker system (see page 23).

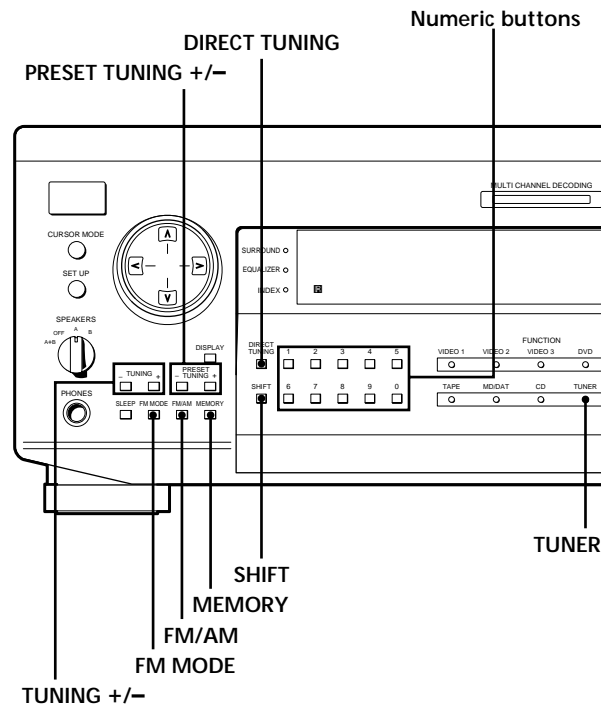

Brief descriptions of buttons used to receive broadcasts

PRESET TUNING +/- buttons: Press to scan all preset radio stations.

DIRECT TUNING button: Press this button to enter a frequency directly using the numeric buttons.

Numeric buttons: Press to enter a numeric value when inputting the frequency directly, presetting radio stations, or tuning to preset stations.

TUNING +/- buttons: Press to scan all available radio stations.

FM MODE button: If “STEREO” flashes in the display and the FM stereo reception is poor, press this button to improve the sound. You will not be able to enjoy stereo effect but the sound will be less distorted.

Note

If “STEREO” does not appear at all even when the FM broadcast is received normally, press this button to turn on the “STEREO” indication.

FM/AM button: Press to select the FM or AM band.

MEMORY button: Uses for memorizing preset stations.

SHIFT button: Press to select a memory page (A, B, or C) for presetting radio stations or tuning to preset stations.

TUNER button: Selects the tuner.

Direct Tuning

For details on the buttons used in this section, see “Brief descriptions of buttons used to receive broadcasts” on this page.

- 1 Press **TUNER** to light the button up.
The last received station is tuned in.
- 2 Press **FM/AM** to select the FM or AM band.
- 3 Press **DIRECT TUNING**.
- 4 Press the numeric buttons to enter the frequency.

Example 1: FM 102.50 MHz



Example 2: AM 1350 kHz

(You don't have to enter the last “0.”)

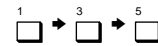

If you cannot tune in a station and the entered numbers flash

Make sure you've entered the right frequency. If not, repeat Steps 3 and 4.

If the entered numbers still flash, the frequency is not used in your area.

- 5 If you've tuned in an AM station, adjust the direction of the AM loop antenna for optimum reception.
- 6 Repeat Steps 2 to 5 to receive another station.

 If you try to enter a frequency that is too precise for the tuning scale

The entered value is automatically rounded up or down.

Tuning scale for direct tuning is:

FM: 50 kHz

AM: 9 kHz

Automatic Tuning

For details on the buttons used in this section, see “Brief descriptions of buttons used to receive broadcasts” on page 38.

- 1 Press **TUNER** to light the button up.
The last received station is tuned in.
- 2 Press **FM/AM** to select the FM or AM band.
- 3 Press **TUNING +** or **TUNING -**.
Press the + button to scan from low to high; press the - button to scan from high to low.

When the receiver reaches either end of the band

Scanning is repeated in the same direction.

The receiver stops scanning whenever a station is received.

- 4 To continue scanning, press **TUNING +** or **TUNING -** again.

Preset Tuning

For details on the buttons used in this section, see “Brief descriptions of buttons used to receive broadcasts” on page 38.

Before tuning to preset stations, be sure to preset them by performing steps on “Presetting radio stations” below.

Presetting radio stations

- 1 Press **TUNER** to light the button up.
The last received station is tuned in.
- 2 Tune in the station that you want to preset using **Direct Tuning** (page 38), or **Automatic Tuning** (this page).
- 3 Press **MEMORY**.
“MEMORY” appears in the display for a few seconds. Do Steps 4 to 6 before “MEMORY” goes out.
- 4 Press **SHIFT** to select a memory page (A, B or C).
Each time you press **SHIFT**, the letter “A”, “B” or “C” appears in the display.
- 5 Select a preset number by pressing it (0 to 9).
If “MEMORY” goes out before you press the preset number, start again from Step 3.
- 6 Press **MEMORY** again to store the station.
If “MEMORY” goes out before you press the preset number, start again from Step 3.
- 7 Repeat Steps 2 to 6 to preset another station.

To change a preset number to another station

Do Steps 1 to 6 to preset the new station to the number.

Note

If the AC power cord is disconnected for about one week, all the preset stations will be cleared from the receiver’s memory, and you will have to preset the stations again.

Preset Tuning

Tuning to preset stations

You can tune the preset stations either of the following two ways.

Scanning the preset stations

- 1 Press TUNER to light the button up.
The last received station is tuned in.
- 2 Press PRESET TUNING + or PRESET TUNING - repeatedly to select the preset station you want.
Each time you press the button, the receiver tunes in one preset station at a time, in the corresponding order and direction as follows:

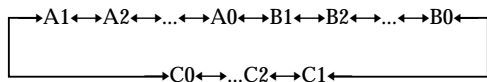

Using the preset codes

- 1 Press TUNER to light the button up.
The last received station is tuned in.
- 2 Press SHIFT to select a memory page (A, B or C), then press the preset number of the station you want using the numeric buttons on the front panel or the supplied remote.

Other Operations

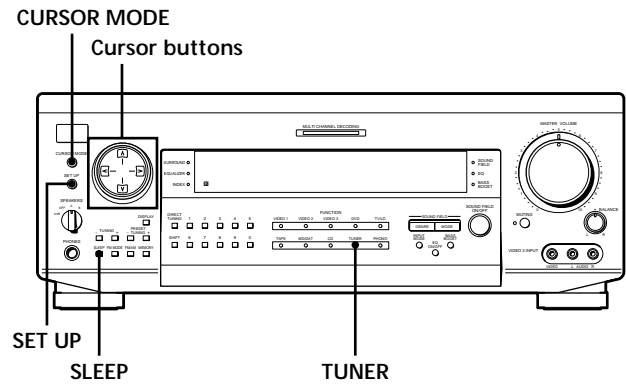

Brief descriptions of buttons that appear in this chapter

CURSOR MODE button: Press repeatedly to light up the INDEX indicator to index preset stations or program sources.

Cursor buttons ($\wedge/\vee/</>$): After pressing the SET UP button or CURSOR MODE button, use these buttons to make the actual setting.

SET UP button: Press repeatedly to display “OTHER”.

SLEEP button: Press to set the sleep timer.

TUNER button: Press to select the tuner.

Indexing Preset Stations and Program Sources

You can enter a name of up to 8 characters for preset stations (station index) and program sources. These index names (for example, "VHS") appear in the receiver's display when a station or program source is selected. Note that no more than one name can be entered for each preset station or program source.

This function is useful for distinguishing components of the same kind. For example, two VCRs can be specified as "VHS" and "8MM," respectively. It is also handy for identifying components connected to jacks meant for another type of component, for example, a second CD player connected to the MD/DAT jacks.

1 To index a preset station

Press TUNER.

The last station you received is tuned in.

To index a program source

Select the program source (component) to be named, then go to Step 3.

2 Tune in the preset station you want to create an index name for.

If you are not familiar with how to tune in preset stations, see "Tuning to preset stations" on page 40.

3 Press CURSOR MODE repeatedly until the INDEX indicator lights up.

4 Create an index name by using the cursor buttons as follows:

Press \wedge or \vee to select a character, then press $\>$ to move the cursor to the next position. The index name is stored automatically.

To insert a space

Press \wedge or \vee until a blank space appears in the display (the space character is between "II" and "A").

If you've made a mistake

Press \leftarrow or \rightarrow repeatedly until the character to be changed flashes, then select the right character.

To assign index names to other stations

Repeat Steps 2 to 4.

Recording

Your receiver makes it easy to record to and from the components connected to it. You don't have to connect the playback and recording components directly to each other: once you select a program source on the receiver, you can record and edit as you normally would using the controls on each component.

Before you begin, make sure you've connected all components properly.

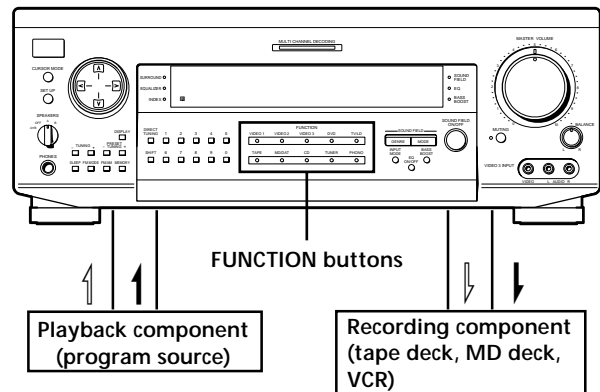

\rightarrow : Audio signal flow
 \rightarrow (lightning bolt): Video signal flow

Recording on an audio tape or MiniDisc

You can record on a cassette tape or MiniDisc using the receiver. See the instruction manual of your cassette deck or MD deck if you need help.

- 1 Select the component to be recorded.
- 2 Prepare the component for playing.
For example, insert a CD into the CD player.
- 3 Insert a blank tape or MD into the recording deck and adjust the recording level, if necessary.
- 4 Start recording on the recording deck, then start playback on the playback component.

Notes

- You cannot record a digital audio signal using a component connected to the analog TAPE REC OUT or MD/DAT REC OUT jacks (STR-DE925) or the analog TAPE/MD REC OUT jacks (STR-DE825). To record a digital audio signal, connect a digital component to the DIGITAL MD/DAT OUT jacks (STR-DE925) or the DIGITAL TAPE/MD OUT jacks (STR-DE825).
- Sound adjustments do not affect the signal output from the TAPE REC OUT or MD/DAT REC OUT jacks (STR-DE925) or the TAPE/MD REC OUT jacks (STR-DE825).

Recording on a video tape

You can record from a VCR, a TV, or an LD player using the receiver. You can also add audio from a variety of audio sources when editing a video tape. See your VCR or LD player's instruction manual if you need help.

- 1 Select the program source to be recorded.
- 2 Prepare the component for playing.
For example, insert the laser disc you want to record into the LD player.
- 3 Insert a blank video tape into the VCR (VIDEO 1 or VIDEO 2) for recording.
- 4 Start recording on the recording VCR, then start playing the video tape or laser disc you want to record.

 You can record the sound from any audio source onto a video tape while copying from a video tape or laser disc. Locate the point where you want to start recording from another audio source, select the program source, then start playback. The audio from that source will be recorded onto the audio track of the video tape instead of the audio from the original medium.

To resume audio recording from the original medium, select the video source again.

Notes

- You cannot record a digital audio signal using a component connected to the analog TAPE REC OUT or MD/DAT REC OUT jacks (STR-DE925) or the analog TAPE/MD REC OUT jacks (STR-DE825). To record a digital audio signal, connect a digital component to the DIGITAL MD/DAT OUT jacks (STR-DE925) or the DIGITAL TAPE/MD OUT jacks (STR-DE825).
- You cannot, however, record multi channel surround digital signals from a DVD, etc.

Using the Sleep Timer

You can set the receiver to turn off automatically at a specified time.

Press SLEEP while the power is on.

Each time you press SLEEP, the time changes as shown below.

→ 2:00:00 → 1:30:00 → 1:00:00 → 0:30:00 → OFF →

The display dims after you have specified the time.

 You can freely specify the time

Press SLEEP first, then specify the time you want using the cursor buttons (▲ or ▼). The sleep time changes in 1 minute intervals. You can specify up to 5 hours.

 You can check the time remaining before the receiver turns off

Press SLEEP. The remaining time appears in the display.

Adjustments Using the SET UP Button

The SET UP button allows you to make following adjustments.

Adjusting the brightness of the display

- 1** Press SET UP repeatedly until "OTHER" appears in the display.
- 2** Press the cursor buttons (^ or v) to select "DIMMER".
- 3** Press the cursor buttons (< or >) to select the brightness level.
You can select any of four brightness levels.

Additional Information

Troubleshooting

If you experience any of the following difficulties while using the receiver, use this troubleshooting guide to help you remedy the problem. Also, see “Checking the connections” on page 19 to verify that the connections are correct. Should any problem persist, consult your nearest Sony dealer.

There’s no sound or only a very low-level sound is heard.

- ➔ Check that the speakers and components are connected securely.
- ➔ Make sure that you’ve selected the correct component on the receiver.
- ➔ Make sure that you’ve set the SPEAKERS selector correctly (see page 23).
- ➔ Press MUTING on the remote if “MUTING” appears in the display.
- ➔ The protective device on the receiver has been activated because of a short circuit. Turn off the receiver, eliminate the short-circuit problem and turn on the power again.

The left and right sounds are unbalanced or reversed.

- ➔ Check that the speakers and components are connected correctly and securely.
- ➔ Adjust the BALANCE control.

Severe hum or noise is heard.

- ➔ Check that the speakers and components are connected securely.
- ➔ Check that the connecting cords are away from a transformer or motor, and at least 3 meters (10 feet) away from a TV set or fluorescent light.
- ➔ Move your TV away from the audio components.
- ➔ Make sure you’ve grounded SIGNAL GND \hbar terminal.
- ➔ The plugs and jacks are dirty. Wipe them with a cloth slightly moistened with alcohol.

No sound is heard from the center speaker.

- ➔ Make sure the sound field function is on (press SOUND FIELD ON/OFF).
- ➔ Select a sound field from the CINEMA or VIRTUAL 3D genre (except MONO MOVIE and STEREO MOVIE) (see page 28).
- ➔ Adjust the speaker volume (see page 18).
- ➔ Make sure the center speaker size parameter is set to either SMALL or LARGE (see page 15).

Troubleshooting

No sound or only a very low-level sound is heard from the rear speakers.

- ➔ Make sure the sound field function is on (press SOUND FIELD ON/OFF).
- ➔ Select a sound field from the CINEMA or VIRTUAL 3D genres (except MONO MOVIE and STEREO MOVIE) (see page 28).
- ➔ Adjust the speaker volume (see page 18).
- ➔ Make sure the rear speaker size parameter is set to either SMALL or LARGE (see page 15).

Recording cannot be done.

- ➔ Check that the components are connected correctly.
- ➔ Select the source component with a FUNCTION button.
- ➔ When recording from a digital component, make sure the input mode is set to ANALOG (see page 23) before recording with a component connected to the analog MD/DAT or TAPE terminals (STR-DE925) or the analog TAPE/MD terminals (STR-DE825).
- ➔ When recording from a digital component, make sure the input mode is set to DIGITAL (see page 23) before recording with the component connected to the DIGITAL MD/DAT OUT terminals (STR-DE925) or the DIGITAL TAPE/MD OUT terminals (STR-DE825).

Radio stations cannot be tuned in.

- ➔ Check that the antennas are connected securely. Adjust the antennas and connect an external antenna if necessary.
- ➔ The signal strength of the stations is too weak (when tuning in with automatic tuning). Use direct tuning.
- ➔ No stations have been preset or the preset stations have been cleared (when tuning by scanning preset stations). Preset the stations (see page 39).
- ➔ Press DISPLAY so that the frequency appears in the display.

The surround effect cannot be obtained.

- ➔ Make sure the sound field function is on (press SOUND FIELD ON/OFF).
- ➔ Make sure that the SPEAKERS selector is set to A or B (not A+B) if you connected two sets of front speakers.

No picture or an unclear picture appears on the TV screen or monitor.

- ➔ Select the appropriate function on the receiver.
- ➔ Set your TV to the appropriate input mode.
- ➔ Move your TV away from the audio components.

The remote does not function.

- ➔ Point the remote at the remote sensor  on the receiver.
- ➔ Remove any obstacles in the path between the remote and the receiver.
- ➔ Replace all batteries in the remote with new ones, if they are weak.
- ➔ Make sure you select the correct function on the remote.
- ➔ If the remote is set to operate the TV only, use the remote to select a source or component other than TV before operating the receiver or other component.

Reference sections for clearing the receiver's memory

To clear	See
All memorized settings	page 19
Customized sound fields	page 35

Specifications

Amplifier section

POWER OUTPUT

Stereo mode (DIN 1 kHz, 8 ohms)
 STR-DE925:
 110 W + 110 W
 STR-DE825:
 100 W + 100 W

Surround mode

(DIN 1 kHz, 8 ohms)
 STR-DE925:
 Front:
 110 W + 110 W
 Center^{a)}: 110W
 Rear^{a)}:
 110 W + 110 W
 STR-DE825:
 Front:
 100 W + 100 W
 Center^{a)}: 100W
 Rear^{a)}:
 100 W + 100 W

a) Depending on the sound field settings and the source, there may be no sound output.

Frequency response

PHONO: RIAA
 equalization curve
 ±0.5 dB
 CD, TAPE, MD/DAT,
 TAPE/MD, DVD,
 TV/LD, VIDEO 1, 2,
 and VIDEO 3
 (STR-DE925 only):
 10 Hz - 50 kHz
 +0.5/-2 dB (with
 sound field,
 equalizer, and bass
 booster bypassed)

Inputs (Analog)

PHONO:
 Sensitivity: 2.5 mV
 Impedance:
 50 kilohms
 S/N^{b)}: 75 dB (A,
 2.5 mV^{c)})
 CD, DVD, TAPE, MD/
 DAT, TAPE/MD,
 TV/LD, VIDEO 1, 2,
 and VIDEO 3
 (STR-DE925 only):
 Sensitivity: 150 mV
 Impedance:
 50 kilohms
 S/N^{b)}: 82 dB (A,
 150 mV^{c)})

b) 78' IHF

c) Weighted network, input level

Inputs (Digital)

DVD (coaxial):
 Sensitivity: -
 Impedance: 75 ohms
 S/N: 100 dB (A,
 20 kHz LPF)
 DVD, TV/LD, MD/
 DAT (Optical):
 Sensitivity: -
 Impedance: -
 S/N: 100 dB (A,
 20 kHz LPF)

Outputs

TAPE, MD/DAT,
 TAPE/MD (REC
 OUT); VIDEO 1, 2
 (AUDIO OUT):
 Voltage: 150 mV,
 Impedance:
 10 kilohms
 WOOFER:
 Voltage: 2 V
 Impedance:
 1 kilohms
 PHONES:
 Accepts low- and
 high-impedance
 headphones

BASS BOOST +6 dB at 70 Hz

Sampling Frequency
 48 kHz

EQ
 BASS:
 100 Hz~1.0kHz
 (21 steps)
 MID:
 500 Hz~5.0kHz
 (21 steps)
 TREBLE:
 1.0 kHz~10kHz
 (21 steps)
 Gain levels:
 ±10 dB, 1 dB step

Specifications

FM tuner section

Tuning range	87.5 - 108.0 MHz
Antenna terminals	75 ohms, unbalanced
Sensitivity	Mono: 18.3 dBf, 2.2 μ V/75 ohms Stereo: 38.3 dBf, 22.5 μ V/75 ohms
Usable sensitivity	11.2 dBf, 1 μ V/75 ohms (IHF)
S/N	Mono: 76 dB Stereo: 70 dB
Harmonic distortion at 1 kHz	Mono: 0.3% Stereo: 0.5%
Separation	45 dB at 1 kHz
Frequency response	30 Hz - 15 kHz +0.5/-2 dB
Selectivity	60 dB at 400 kHz

AM tuner section

Tuning range	531 - 1602 kHz (9-kHz step)
Antenna	Loop antenna
Usable sensitivity	50 dB/m (at 999 kHz)
S/N	54 dB (at 50 mV/m)
Harmonic distortion	0.5 % (50 mV/m, 400 Hz)
Selectivity	35 dB

Video section

Inputs	1 Vp-p 75 ohms
Outputs	1 Vp-p 75 ohms

General

System	Tuner section: PLL quartz-locked digital synthesizer system Preamplifier section: Low-noise NF type equalizer Power amplifier section: Pure-complementary SEPP
Power requirements	220 ~ 230 V AC, 50/60 Hz
Power consumption	STR-DE925: 290 W STR-DE825: 280 W
AC outlets	1 switched, 100 W maximum
Dimensions	430 × 370 × 155 mm including projecting parts and controls
Mass (Approx.)	11.5 kg
Supplied accessories	See page 4.

These values were measured using a supply voltage of 230 V AC, 50/60 Hz.

Design and specifications are subject to change without notice.

Glossary

Surround sound

Sound that consists of three elements: direct sound, early reflected sound (early reflections) and reverberative sound (reverberation). The acoustics of the surrounding space affect the way these three sound elements are heard. Surround sound combines these sound elements in such a way that you actually can sense the size of the venue, as well as its type.

- Types of sound

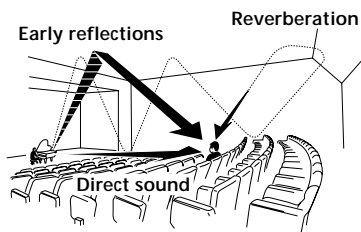

- Transition of sound from rear speakers

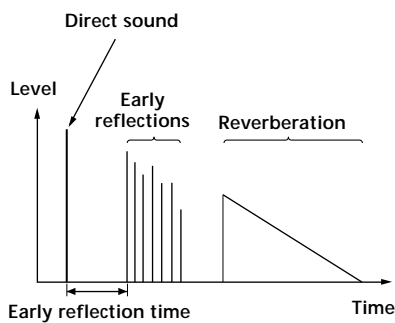

Dolby Pro Logic Surround

As one method of decoding Dolby Surround, Dolby Pro Logic Surround produces four channels from two-channel sound. Compared with the former Dolby Surround system, Dolby Pro Logic Surround reproduces left-to-right panning more naturally and localizes sounds more precisely. To take full advantage of Dolby Pro Logic Surround, you should have one pair of rear speakers and a center speaker. The rear speakers output monaural sound.

Dolby Digital (AC-3)

This sound format for movie theaters is more advanced than Dolby Pro Logic Surround. In this format, the rear speakers output stereo sound with an expanded frequency range and a subwoofer channel for deep bass is independently provided. This format is also called "5.1" because the subwoofer channel is counted as 0.1 channel (since it functions only when a deep bass effect is needed). All six channels in this format are recorded separately to realize superior channel separation. Furthermore, since all the signals are processed digitally, less signal degradation occurs. The name "AC-3" comes from the fact that it is the third audio coding method to be developed by the Dolby Laboratories Licensing Corporation.

Digital Cinema Sound

This is the generic name of the surround sound produced by digital signal processing technology developed by Sony. Unlike previous surround sound fields mainly directed at the reproduction of music, Digital Cinema Sound is designed specifically for the enjoyment of movies.

Tables of Settings Using the CURSOR MODE and SET UP buttons

You can make various settings using the CURSOR MODE, SET UP, and cursor buttons. The tables below show each of the settings that these buttons can make.

Press CURSOR MODE repeatedly to light up	Press \wedge or \vee to select	Then \leftarrow or \rightarrow to select	See page
SURROUND indicator	EFFECT LEVEL	depends on sound mode (in 21 steps)	33
	WALL TYPE	between -8 to +8 (in 1 increment steps)	
	REVERBERATION TIME	between -8 to +8 (in 1 increment steps)	
	LFE MIX LEVEL	MUTING, or -20 dB to 0 dB (in 1 dB steps)	
	DYNAMIC RANGE COMP	OFF, 0.1 to 0.9 (in 0.1 dB steps), STD, or MAX	
	REAR BALANCE	between -8 to +8 (in 1 increment steps)	
	REAR LEVEL	between -10 dB to +10 dB (in 1 dB steps)	
	CENTER LEVEL	between -10 dB to +10 dB (in 1 dB steps)	
	SUB WOOFER LEVEL	between -10 dB to +10 dB (in 1 dB steps)	
EQUALIZER indicator	FRONT BASS GAIN	between -10 dB to +10 dB (in 1 dB steps)	34
	FRONT BASS FREQUENCY	between 100 Hz and 1.0 kHz (in 21 steps)	
	FRONT MID GAIN	between -10 dB to +10 dB (in 1 dB steps)	
	FRONT MID FREQUENCY	between 500 Hz and 5.0 kHz (in 21 steps)	
	FRONT TREBLE GAIN	between -10 dB to +10 dB (in 1 dB steps)	
	FRONT TREBLE FREQUENCY	between 1.0 kHz and 10 kHz (in 21 steps)	
	CENTER BASS GAIN	between -10 dB to +10 dB (in 1 dB steps)	
	CENTER BASS FREQUENCY	between 100 Hz and 1.0 kHz (in 21 steps)	
	CENTER MID GAIN	between -10 dB to +10 dB (in 1 dB steps)	
	CENTER MID FREQUENCY	between 500 Hz and 5.0 kHz (in 21 steps)	
	CENTER TREBLE GAIN	between -10 dB to +10 dB (in 1 dB steps)	
	CENTER TREBLE FREQUENCY	between 1.0 kHz and 10 kHz (in 21 steps)	
	REAR BASS GAIN	between -10 dB to +10 dB (in 1 dB steps)	
	REAR BASS FREQUENCY	between 100 Hz and 1.0 kHz (in 21 steps)	
	REAR MID GAIN	between -10 dB to +10 dB (in 1 dB steps)	
	REAR MID FREQUENCY	between 500 Hz and 5.0 kHz (in 21 steps)	
	REAR TREBLE GAIN	between -10 dB to +10 dB (in 1 dB steps)	
REAR TREBLE FREQUENCY	between 1.0 kHz and 10 kHz (in 21 steps)		
INDEX indicator	a character	the cursor position	42

Press SET UP repeatedly to display	Press \wedge or \vee to select	Then \lt or \gt to select	See page
SPEAKER SETUP	FRONT SPEAKER	LARGE or SMALL	15
	CENTER SPEAKER	LARGE, SMALL, or NO	
	REAR SPEAKER	LARGE, SMALL, or NO	
	REAR SPEAKER POSITION	SIDE, MIDDLE, or BEHIND	
	REAR SPEAKER HEIGHT	LOW or HIGH	
	SUB WOOFER	YES or NO	
SPEAKER DISTANCE	FRONT SPEAKER	between 1.0 meters (3 feet) and 12.0 meters (40 feet) (in 0.1 meter (1 foot) steps)	17
	CENTER SPEAKER	between FRONT and 1.5 meters (5 feet) (in 0.1 meter (1 foot) steps)	
	REAR SPEAKER	between FRONT and 4.5 meters (15 feet) (in 0.1 meter (1 foot) steps)	
	DISTANCE UNIT	METER or FEET	
OTHER	DIMMER	among four levels of brightness	44

Index

A

- AC-3. *See Dolby Digital (AC-3)*
- Adjusting
 - brightness of the display 44
 - equalizer 34
 - speaker volumes 18
 - surround parameters 33
- Automatic tuning 39

B

- Basic operations 22~25
- Battery 4

C

- Changing
 - display 24
 - effect level 33
- Checking the connections 19
- Clearing receiver's memory 19
- Connecting. *See Hookups*
- Customizing sound fields 33

D

- Digital Cinema Sound 49
- Direct tuning 38
- Dolby Digital (AC-3) 49
- Dolby Pro Logic Surround 49
- Dubbing. *See Recording*

E, F, G

- Editing. *See Recording*
- Effect level 33
- EQ 34

H

- Hookups
 - AC power cord 11
 - antennas 5
 - audio components 6, 7
 - digital components 9, 10
 - S-LINK CONTROL A1 11
 - speaker system 13
 - video components 8

I, J, K

- Indexing
 - preset stations 42
 - program sources 42

L, M, N, O

- Labeling. *See Indexing*

P, Q

- Parameter 36, 50, 51
- Preset stations
 - how to preset 39
 - how to tune 40

R

- Receiving broadcasts
 - automatically 39
 - directly 38
 - preset stations 39
- Recording
 - on an audio tape or MD 42
 - on a video tape 43

S

- Scanning
 - preset stations. *See Preset tuning*
 - radio stations. *See Automatic tuning*
- Selecting
 - component 22
 - front speaker system 23
 - sound field 27
- Sleep timer 43
- Sound field
 - adjustable parameters 36
 - customizing 33
 - pre-programmed 27~30
 - resetting 35
 - selecting 27

Speakers

- adjusting speaker volume 18
- connection 13
- front speakers (A/B) 23
- impedance 14
- placement 14
- Station index. *See Indexing*
- Supplied accessories 4
- Surround sound 14~18, 26~36

T

- Test tone 18
- Tuning
 - automatically 39
 - directly 38
 - preset stations 39

U, V, W, X, Y, Z

- Unpacking 4