

CD/DVD Player

Operating Instructions

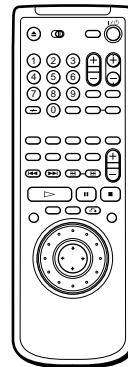
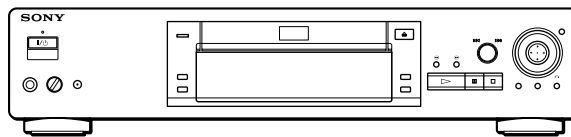

DVP-S725D

WARNING

To prevent fire or shock hazard, do not expose the unit to rain or moisture. To avoid electrical shock, do not open the cabinet. Refer servicing to qualified personnel only.

Mains cord must only be changed at qualified service shop.

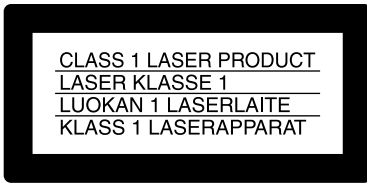

This appliance is classified as a CLASS 1 LASER product. The CLASS 1 LASER PRODUCT MARKING is located on the rear exterior.

CAUTION

The use of optical instruments with this product will increase eye hazard. As the laser beam used in this CD/DVD player is harmful to eyes, do not attempt to disassemble the cabinet.

Refer servicing to qualified personnel only.



This label is located on the Laser protective housing inside the enclosure.

Welcome!

Thank you for purchasing the Sony CD/DVD Player. Before operating the unit, please read this manual thoroughly and retain it for future reference.

Precautions

Safety

- This unit operates on 220 - 240 V AC, 50/60 Hz. Check that the unit's operating voltage is identical with your local power supply.
- If anything falls into the cabinet, unplug the unit and have it checked by qualified personnel before operating it any further.
- The unit is not disconnected from the mains as long as it is connected to the mains outlet, even if the unit itself has been turned off.
- Unplug the unit from the wall outlet if you do not intend to use it for an extended period of time. To disconnect the cord, pull it out by the plug, never by the cord.

Installing

- Allow adequate air circulation to prevent internal heat buildup.
- Do not place the unit on surfaces (rugs, blankets, etc.) or near materials (curtains, draperies) that may block the ventilation slots.
- Do not install the unit near heat sources such as radiators or air ducts, or in a place subject to direct sunlight, excessive dust, mechanical vibration or shock.
- Do not install the unit in an inclined position. It is designed to be operated in a horizontal position only.
- Keep the unit and discs away from equipment with strong magnets, such as microwave ovens or large loudspeakers.
- Do not place heavy objects on the unit.
- If the unit is brought directly from a cold to a warm location, moisture may condense inside the CD/DVD player and cause damage to the lenses. When you first install the unit, or when you move it from a cold to a warm location, wait for about one hour before operating the unit.

TABLE OF CONTENTS

About This Manual	4
This Player Can Play the Following Discs	4
Precautions	6
Notes on Discs	6

Getting Started 7

Unpacking	7
TV Hookups	8
Receiver (Amplifier) Hookups	12
5.1 Channel Surround Hookups	14
Selecting the Language for On-Screen Display	16

Playing Discs 17

Playing Discs	17
Playing at Various Speeds/Frame by Frame	19
Resuming Playback from the Point Where You Stopped the Disc (Resume Play)	20
Using the Menu for Each DVD	21
Playing VIDEO CDs with PBC Functions (PBC Playback)	22
Using the Front Panel Display	23

Using Various Functions with the Control Menu 25

Using the Control Menu Display	25
Control Menu Item List	27
Searching for the Title/Chapter/Track/Index/Scene	28
Checking the Playing Time and Remaining Time	29
Selecting a Start Point Using the Time Code	30
Checking the Information of the Disc	31
Changing the Sounds	33
Displaying the Subtitles	34
Changing the Angles	35
Setting for Digital Cinema Sound	36
Creating Your Own Program (Program Play)	38
Playing in Random Order (Shuffle Play)	40
Playing Repeatedly (Repeat Play)	41
Repeating a Specific Portion (A↔B Repeat)	41
Checking the Play Information	43
Reducing the Picture Noise (DNR: Digital Video Noise Reduction)	45
Adjustments for Playback Picture (VIDEO EQ: Video Equalizer)	45

Displaying Different Angles Simultaneously	47
Dividing a Track into 9 Sections (Strobe Play)	47
Scanning the Title, Chapter and Track	48
Setting and Selecting Favorite Scene (Bookmark)	48

Settings and Adjustments 49

Using the Setup Display	49
Setup Display Item List	51
Setting the Language for Display and Sound (LANGUAGE SETUP)	52
Settings for Display (SCREEN SETUP)	53
Custom Settings (CUSTOM SETUP)	54
Settings for Sound (AUDIO SETUP)	58
Speaker Set Up	61
Controlling the TV or the AV Receiver (Amplifier) with the Supplied Remote	63





Additional Information 65

Troubleshooting	65
Self-diagnosis function	68
Specifications	69
Glossary	70
Language Code List	72
Index to Parts and Controls	73
Index	76

About This Manual

Conventions

- Instructions in this manual describe the controls on the player. You can also use the controls on the remote if they have the same or similar names as those on the player.
- The icons on the right are used in this manual:

Icon	Meaning
	Indicates that you can use only the remote to do the task.
	Indicates tips and hints for making the task easier.
	Indicates the functions for DVD VIDEOS.
	Indicates the functions for VIDEO CDs.
	Indicates the functions for Audio CDs.

This Player Can Play the Following Discs

	DVD VIDEOS		VIDEO CDs		Audio CDs	
Disc logo						
Contents	Audio + Video		Audio + Video		Audio	
Disc size	12 cm	8 cm	12 cm	8 cm	12 cm	8 cm (CD single)
Play time	About 4 h (for single-sided DVD)/ about 8 h (for double-sided DVD)	About 80 min. (for single-sided DVD)/ about 160 min. (for double-sided DVD)	74 min.	20 min.	74 min.	20 min.

“DVD VIDEO” logo is a trademark.

When you play an NTSC disc, this player outputs the video signal in the NTSC system only. In this case, if your TV is a PAL system mode, the picture becomes noisy.

Region code of DVDs you can play on this unit

Your DVD player has a region code printed on the back of the unit and will only play DVDs that are labeled with identical region codes.

DVDs labeled  will be also played on this unit.

If you try to play any other DVD, the message “Playing this disc prohibited by area limits.” will appear on the TV screen.

Depending on the DVD, no region code indication may be labeled even though playing the DVD is prohibited by the area limits.

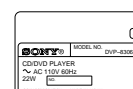

Region code

Note on playback operations of DVDs and VIDEO CDs

Some playback operations of DVDs and VIDEO CDs may be intentionally fixed by software producers. Since this player plays DVDs and VIDEO CDs according to the disc contents the software producers designed, some playback features may not be available. Also refer to the instructions supplied with the DVDs or VIDEO CDs.

Terms for discs

- **Title**
The longest sections of a picture or a music piece on a DVD; a movie, etc., for a picture piece on a video software; or an album, etc., for a music piece on an audio software. Each title is assigned a title number enabling you to locate the title you want.
- **Chapter**
Sections of a picture or a music piece that are smaller than titles. A title is composed of several chapters. Each chapter is assigned a chapter number enabling you to locate the chapter you want. Depending on the disc, no chapters may be recorded.
- **Track**
Sections of a picture or a music piece on a VIDEO CD or a CD. Each track is assigned a track number enabling you to locate the track you want.

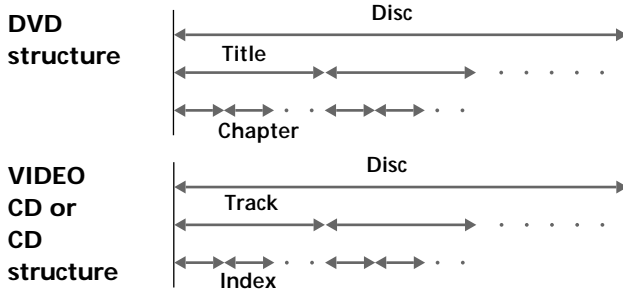

- **Index (CD) / Video Index (VIDEO CD)**
A number that divides a track into sections to easily locate the point you want on a VIDEO CD or a CD. Depending on the disc, no indexes may be recorded.
- **Scene**
On a VIDEO CD with PBC functions, the menu screens, moving pictures and still pictures are divided into sections called "scenes." Each scene is assigned a scene number enabling you to locate the scene you want.

Note on PBC (Playback Control) (VIDEO CDs)

This player conforms to Ver. 1.1 and Ver. 2.0 of VIDEO CD standards. You can enjoy two kinds of playback according to the disc type.

Disc type	You can
VIDEO CDs without PBC functions (Ver. 1.1 discs)	Enjoy video playback (moving pictures) as well as music.
VIDEO CDs with PBC functions (Ver. 2.0 discs)	Play interactive software using menu screens displayed on the TV screen (PBC Playback), in addition to the video playback functions of Ver 1.1 discs. Moreover, you can play high-resolution still pictures, if they are included on the disc.

Discs that the player cannot play

The player cannot play discs other than the ones listed in the table on page 4. CD-R, CD-ROMs including PHOTO CDs, data sections in CD-EXTRAS, DVD-ROMs etc., cannot be played.

When playing DTS*-encoded CDs, excessive noise will be heard from the analog stereo outputs. To avoid possible damage to the audio system, the consumer should take proper precautions when the analog stereo outputs of the DVD player are connected to an amplification system. To enjoy DTS Digital Surround™ playback, an external 5.1-channel DTS Digital Surround™ decoder system must be connected to the digital output of the DVD player.

This product incorporates copyright protection technology that is protected by method claims of certain U.S. patents and other intellectual property rights owned by Macrovision Corporation and other rights owners. Use of this copyright protection technology must be authorized by Macrovision Corporation, and is intended for home and other limited viewing uses only unless otherwise authorized by Macrovision Corporation. Reverse engineering or disassembly is prohibited.

* "DTS" is a trademark of Digital Theater Systems, Inc.

Precautions

On safety

- Caution – The use of optical instruments with this product will increase eye hazard.
- Should any solid object or liquid fall into the cabinet, unplug the player and have it checked by qualified personnel before operating it any further.

On power sources

- The player is not disconnected from the AC power source (mains) as long as it is connected to the wall outlet, even if the player itself has been turned off.
- If you are not going to use the player for a long time, be sure to disconnect the player from the wall outlet. To disconnect the AC power cord (mains lead), grasp the plug itself; never pull the cord.
- Should the AC power cord (mains lead) need to be changed, have it done at a qualified service shop only.

On placement

- Place the player in a location with adequate ventilation to prevent heat build-up in the player.
- Do not place the player on a soft surface such as a rug that might block the ventilation holes on the bottom.
- Do not place the player in a location near heat sources, or in a place subject to direct sunlight, excessive dust or mechanical shock.

On operation

- If the player is brought directly from a cold to a warm location, or is placed in a very damp room, moisture may condense on the lenses inside the player. Should this occur, the player may not operate properly. In this case, remove the disc and leave the player turned on for about half an hour until the moisture evaporates.

On adjusting volume

- Do not turn up the volume while listening to a portion with very low level inputs or no audio signals. If you do, the speakers may be damaged when a peak level portion is played.

On cleaning

- Clean the cabinet, panel and controls with a soft cloth slightly moistened with a mild detergent solution. Do not use any type of abrasive pad, scouring powder or solvent such as alcohol or benzine.

If you have any questions or problems concerning your player, please consult your nearest Sony dealer.

IMPORTANT NOTICE

Caution: The enclosed DVD player is capable of holding a still video image or On screen display image on your television screen indefinitely. If you leave the still video image or On screen display image displayed on your TV for an extended period of time you risk permanent damage to your television screen. Projection televisions are very susceptible.

Notes on Discs

On handling discs

- To keep the disc clean, handle the disc by its edge. Do not touch the surface.
- Do not stick paper or tape on the disc. If there is glue (or a similar substance) on the disc, remove the glue completely before using the disc.

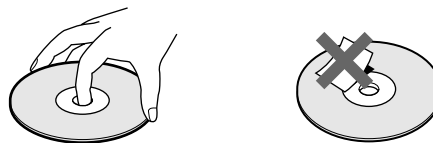

- Do not expose the disc to direct sunlight or heat sources such as hot air ducts, or leave it in a car parked in direct sunlight as there can be considerable rise in temperature inside the car.
- After playing, store the disc in its case.

On cleaning

- Before playing, clean the disc with a cleaning cloth. Wipe the disc from the center out.

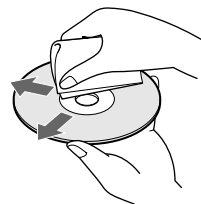

- Do not use solvents such as benzine, thinner, commercially available cleaners or anti-static spray intended for vinyl LPs.

Getting Started

This section describes how to hook up the CD/DVD player to a TV (with audio/video input jacks) and/or an AV receiver (amplifier). You cannot connect this player to a TV which does not have a video input connector. Be sure to turn off the power of each component before making the connections.

Unpacking

Check that you have the following items:

- Audio/video connecting cord (1)
- S video cord (1)
- Remote commander (remote) RMT-D111P (1)
- R6 (size AA) batteries (2)

Inserting batteries into the remote

You can control the player using the supplied remote. Insert two R6 (size AA) batteries by matching the + and - on the batteries. When using the remote, point it at the remote sensor  on the player.

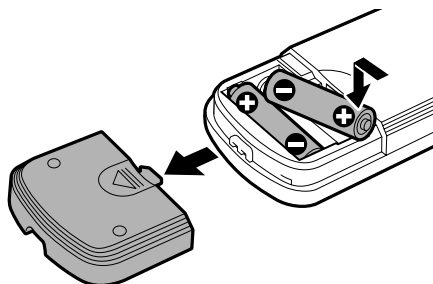

 You can control TVs and AV receivers using the supplied remote
See page 63.

Notes

- Do not leave the remote in an extremely hot or humid place.
- Do not drop any foreign object into the remote casing, particularly when replacing the batteries.
- Do not expose the remote sensor to direct sunlight or lighting apparatuses. Doing so may cause a malfunction.
- If you will not use the remote for an extended period of time, remove the batteries to avoid possible damage from battery leakage and corrosion.

TV Hookups

This connection is for listening to the sound through TV speakers (2ch – L,R). Refer to the instructions supplied with the component to be connected. You cannot connect this player to a TV without an EURO AV (SCART) connector or a video input connector.

Required cords

EURO-AV (SCART) connecting cord (not supplied) (2)
Be sure to make connections firmly to avoid hum and noise. Refer to the instructions supplied with the TV to be connected.



Notes

- When you set “EURO AV OUT” to “S VIDEO” or “RGB” under “CUSTOM SETUP” in the setup display, use the EURO AV (SCART) connecting cord conforming to each signal.
- When you connect using the EURO-A V connecting cord, confirm that the TV corresponds to S VIDEO or RGB. Refer to the instructions supplied with the TV to be connected.

CD/DVD player

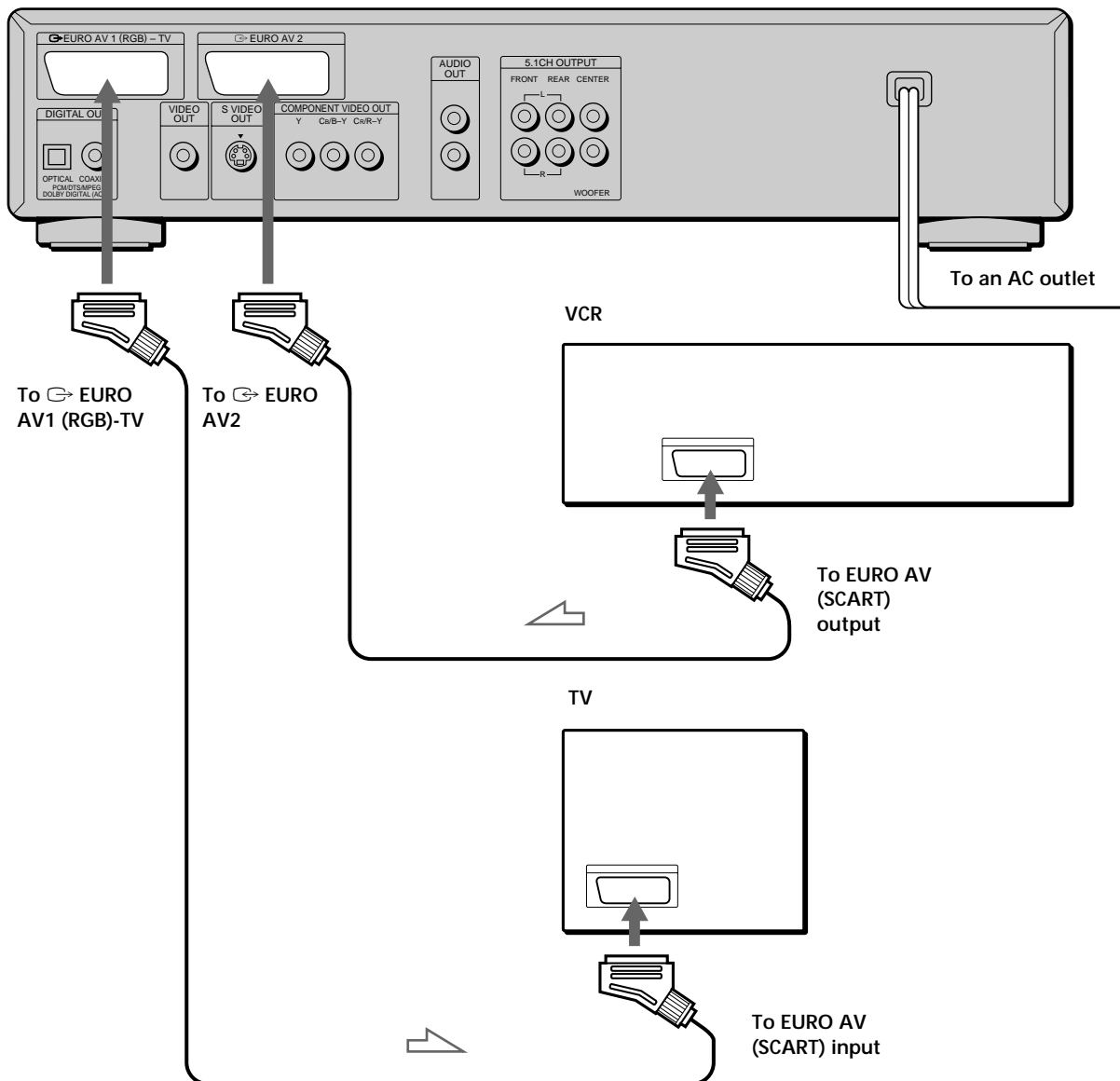

 : Signal flow

If your TV has two EURO AV (SCART) connectors

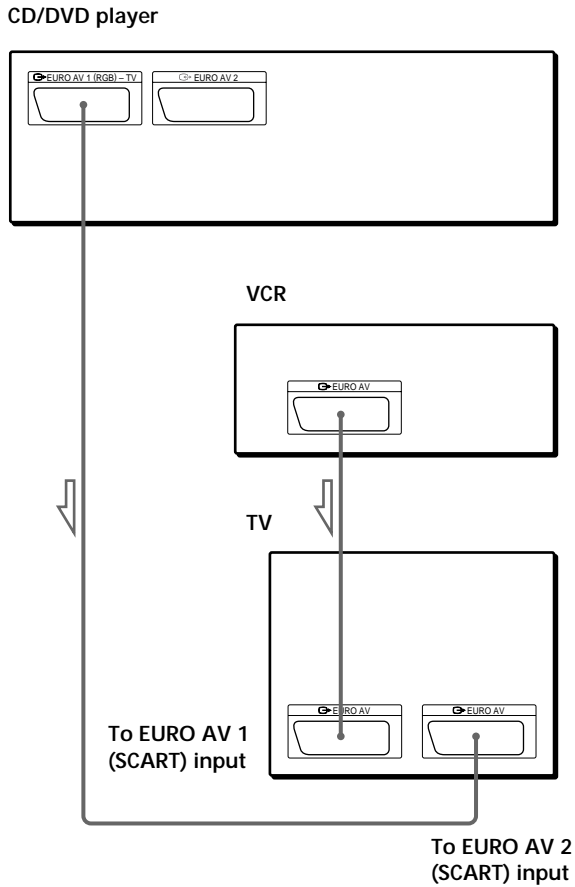

If your TV has no EURO AV (SCART) connectors

You can connect the player to a TV (with audio/video input jacks) using the supplied audio/video connecting cord. If your TV has an S video input connector, connect the component via the S VIDEO OUT connector using the S video cord (supplied) instead of the video connecting cord. You will get a better picture. When connecting the cords, be sure to match the color-coded cord to the appropriate jacks on the components: Yellow (video) to Yellow, Red (right) to Red and White (left) to White.

Audio/Video connecting cord (supplied)

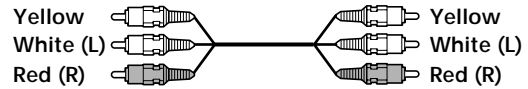

S video cord (supplied)

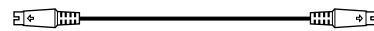

■ **To listen to the sound through TV speakers**

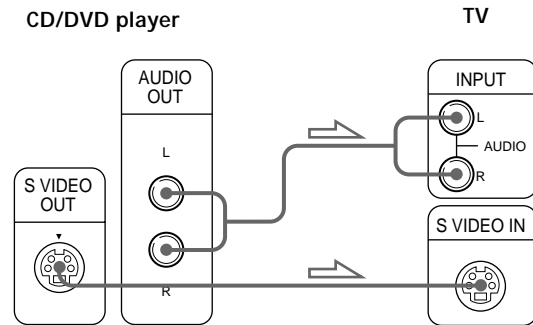

■ **If your TV has no S video input connector**

Connect the component via the VIDEO INPUT connector using the video connecting cord (not supplied) instead of the S video cord.

Video connecting cord (not supplied)

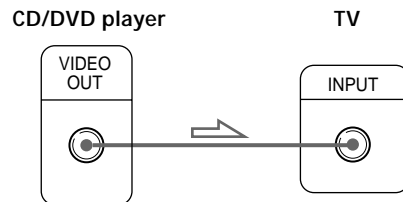

If you connect the player to a monitor or projector having component video input connectors that conform to output signals from the COMPONENT VIDEO OUT (Y, C_B/B-Y, C_R/R-Y) connectors on the player

Connect the component via the COMPONENT VIDEO OUT connectors using three video connecting cords (not supplied) of the same kind. You will get a better picture.

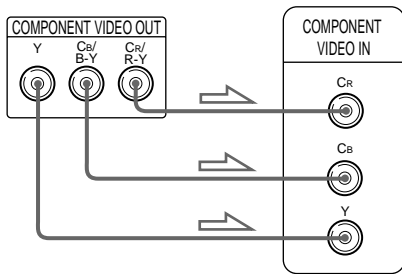

In this case, set "EUROAV OUT" in "CUSTOM SETUP" to "VIDEO" or "S VIDEO" in the setup display and set "COMPONENT OUT" to "ON." (page 54)

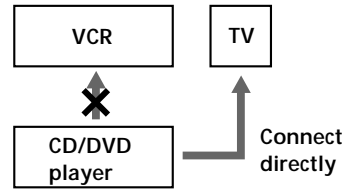

Notes

- When you set "EURO A V OUT" in "CUSTOM SETUP" to "RGB", you cannot select the item "COMPONENT OUT" in "CUSTOM SETUP"
- Refer to the instructions supplied with the component to be connected.
- Do not connect this player to a video deck. If you view the pictures on your TV after making the connections shown below, a picture noise may appear.



- Depending on the TV or receiver (amplifier), sound distortion may occur because the audio output level is high. In this case, set "AUDIO ATT" in "AUDIO SETUP" to "ON" in the setup display. For details, see page 58.
- If you cannot view the pictures from a VCR through this player which is connected to a TV with RGB, set 1 to  (Audio/Video) on your TV. When you select  (RGB), the TV cannot receive the signal from the VCR.
- If you want to enjoy the picture with RGB signal via EURO A V 1 (RGB) connector, set "COMPONENT OUT" in the "CUSTOM SETUP" to "OFF" then set "EURO A V OUT" to "RGB" in the setup display. For details, see page 54.
- If you want to use SmartLink function of a VCR, connect the VCR to a TV with the connector conformed to SmartLink function and connect the CD/DVD player to the TV with another connector.
- When you connect the player to a monitor or projector via only the COMPONENT VIDEO OUT connectors, do not select "OFF" in "COMPONENT OUT" under "CUSTOM SETUP" If you select "OFF" in this case, the picture may not appear.

Setups for the player

Some setups are necessary for the player depending on the TV or other components to be connected.

Use the setup display to change the various settings.

For details on using the setup display, see page 49.

- **To connect the player to a wide-screen TV**
In the setup display, set "TV TYPE" in "SCREEN SETUP" to "16:9" (default setting). For details, see page 53.
- **To connect the player to a normal TV**
In the setup display, set "TV TYPE" in "SCREEN SETUP" to "4:3 LETTER BOX" or "4:3 PAN SCAN." For details, see page 53.
- **To connect the player to a TV or VCR via EUROAV connector that conforms to the S video signals or RGB signals**
In the setup display, set "EURO AV OUT" in "CUSTOM SETUP" to "S VIDEO" or "RGB." For details, see page 54.
- **To connect the player to a monitor or projector with component video input connectors that conform to output signals from the COMPONENT VIDEO OUT (Y, CB/B-Y, CR/R-Y) connectors on the player**
In the setup display, set "COMPONENT OUT" in "CUSTOM SETUP" to "ON." This is default setting. For details, see page 54.

This player conforms to the PAL color system. When you play a disc recorded in the NTSC color system, the player outputs the video signal or the setup display etc. in the NTSC color system and the picture may not appear on the TV screen. In this case, open the disc tray and remove the disc.

Receiver (Amplifier) Hookups

This connection is for listening to the sound through speakers connected to a receiver (amplifier such as an integrated stereo amplifier, a receiver having a built-in Dolby Pro Logic decoder, etc.). Refer to the instructions supplied with the component to be connected. You can enjoy 5.1 channel surround sound by connecting a receiver (amplifier) with 5.1 channel inputs. See page 36.



 You can enjoy surround when connecting front speakers only. You can use 3D sound imaging to create virtual rear speakers from the sound of the front speakers (L, R) without using actual rear speakers (Virtual Enhanced Surround). For details, see page 36.

Required cords

Audio connecting cord (not supplied) (1)

S video cord (supplied) (1)

When connecting the cords, be sure to match the color-coded cord to the appropriate jacks on the components: Red (right) to Red and White (left) to White. Be sure to make connections firmly to avoid hum and noise.

White (L)  White (L)
Red (R)  Red (R)



CD/DVD player

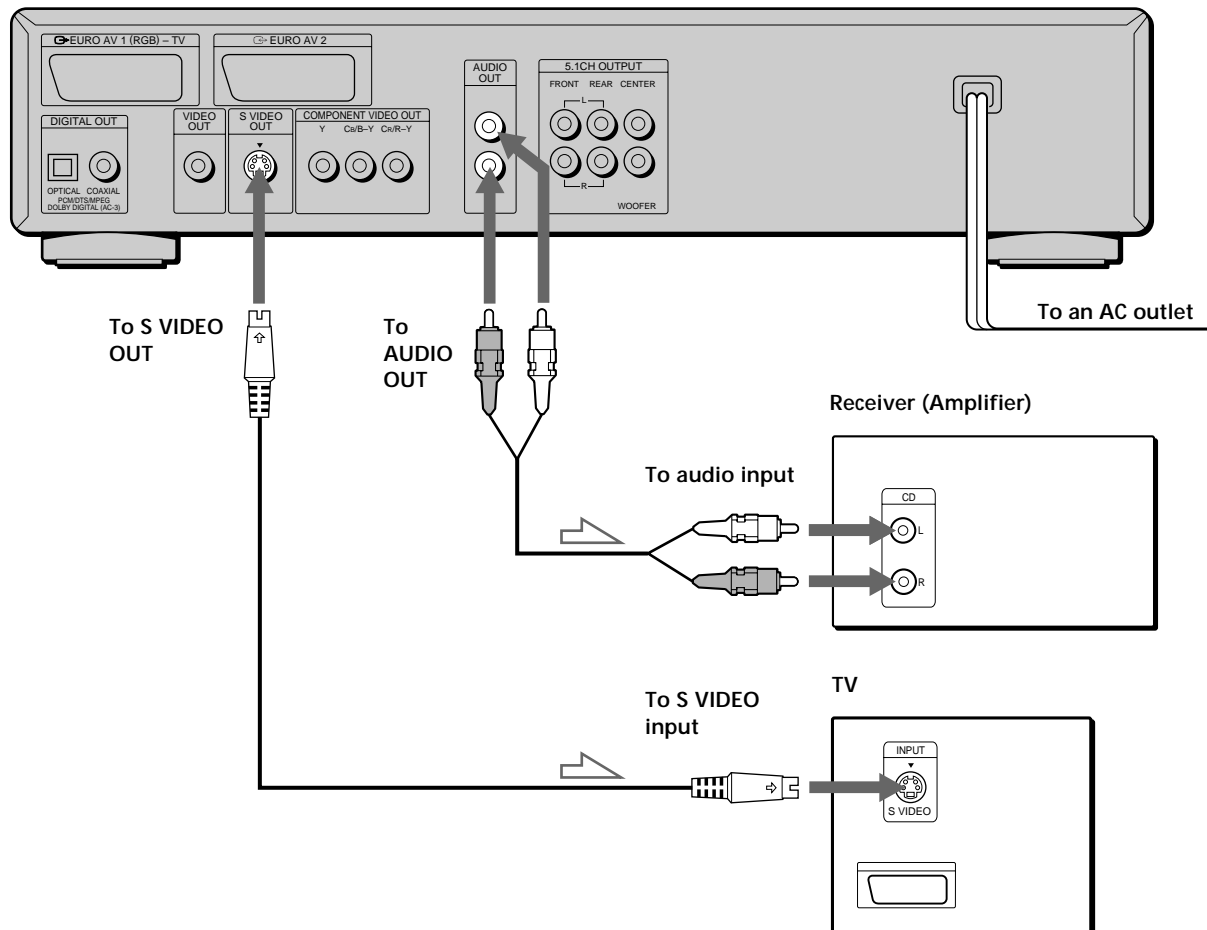

 : Signal flow

Note

You cannot enjoy the picture with S video signal if your TV is not conformed to the S video signal. When your TV does not have S VIDEO input, connect the component via the VIDEO INPUT connector using the video connecting cord (not supplied) instead of the S video cord. For details, see page 9. Refer to the instructions supplied with your TV.

If you have a digital component such as a receiver (amplifier) with a digital connector, DAT or MD

Connect the component via the DIGITAL OUT OPTICAL or COAXIAL connector using an optical or coaxial digital connecting cord (not supplied).

When you play a DVD, set "DIGITAL OUT" in "AUDIO SETUP" to "ON" and then set "DOLBY DIGITAL" to "D-PCM", "MPEG" to "PCM" and "DTS" to "OFF" in the setup display (page 59)

■ When using an optical digital connecting cord

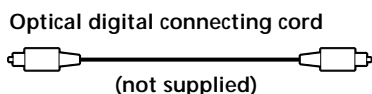

Take off the cap and plug in the optical digital connecting cord.

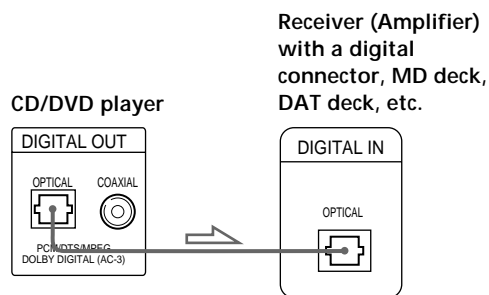

■ When using a coaxial digital connecting cord

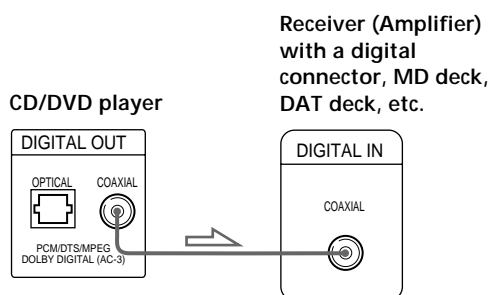
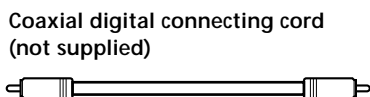

Notes

- Refer to the instructions supplied with the component to be connected.
- You cannot make digital audio recordings of discs recorded in multi-channel surround format directly using an MD deck or DAT deck.

When you make the connections above, do not set "DOLBY DIGITAL" to "DOLBY DIGITAL", "MPEG" to "MPEG" and "DTS" to "ON." If you do, a loud noise will suddenly come out from the speakers, affecting your ears or causing the speakers to be damaged.

If you have an audio component with a built in DTS decoder, Dolby Digital decoder or MPEG decoder

Connect the component via the DIGITAL OUT OPTICAL or COAXIAL connector using an optical or coaxial digital connecting cord (not supplied).

- When you play a DVD that is recorded in DTS format
Set "DIGITAL OUT" in "AUDIO SETUP" to "ON" and then set "DTS" to "ON" in the setup display (page 59)
- When you play a DVD that is recorded in Dolby Digital format
Set "DIGITAL OUT" in "AUDIO SETUP" to "ON" and then set "DOLBY DIGITAL" to "DOLBY DIGITAL" in the setup display. (page 59)
- When you play a DVD that is recorded in MPEG format
Set "DIGITAL OUT" in "AUDIO SETUP" to "ON" and then set "MPEG" to "MPEG" in the setup display (page 59)

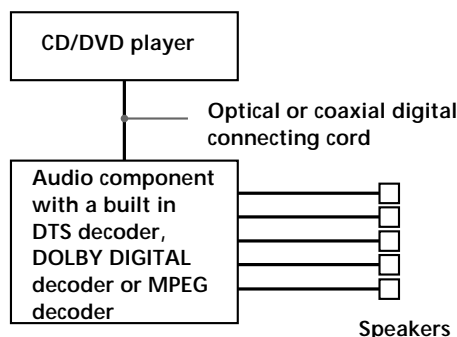

Notes

- Refer to the instructions supplied with the component to be connected.
- When you do not connect an audio component with a built in DTS decoder, do not set "DTS" to "ON."
- When you do not connect an audio component with a built in DOLBY DIGITAL decoder, do not set "DOLBY DIGITAL" to "DOLBY DIGITAL."
- When you do not connect an audio component with a built in MPEG decoder, do not set "MPEG" to "MPEG."

Setups for the player

Some setups are necessary for the player depending on the components to be connected.

Use the setup display to change the various settings.

For details on using the setup display, see page 49.

- To listen to the sound through speakers connected to a receiver (amplifier) having a digital connector or to output the sound to a digital component such as a DAT or MD deck

When you play a DVD, set "DIGITAL OUT" in "AUDIO SETUP" to "ON" and then set "DOLBY DIGITAL" to "D-PCM", "MPEG" to "PCM" and "DTS" to "OFF" in the setup display (page 59). These are the default settings.

5.1 Channel Surround Hookups

Some DVDs have a sound track with up to 5.1 channels recorded in Dolby* Digital or MPEG AUDIO format. Using a receiver (amplifier) having 5.1 channel inputs and the 5 (+1) speakers, you can enjoy more real audio presence in the comfort of your own home.

“5 channel” stands for the 2 front speakers (Left and Right), 2 rear speakers (Left and Right) and 1 center speaker. The “0.1 channel” (+1) stands for the subwoofer which outputs the bass.

Even if you have fewer than 5 (+1) speakers, the player distributes the output signal to the speakers appropriately. This player has VIRTUAL 3D SURROUND mode.

You can use the 3D sound imaging to shift the sound of the rear speakers away from the actual speaker position (VIRTUAL REAR SHIFT) or to create 3 sets of virtual rear speakers from 1 set of actual rear speakers (VIRTUAL MULTI REAR). For details on the VIRTUAL 3D SURROUND mode, see page 36.

Note

When a DVD has a sound track with 7.1 channels recorded in MPEG AUDIO format, the output audio signals are mixed down to 5.1 channels.

Speaker placement

For the best possible surround sound, we recommend the following conditions.

- Use higher performance speakers.
- Use rear and center speakers that match your front speakers in size and performance.
- All speakers should be the same distance from the listening position.
- Place the subwoofer between the front (L, R) speakers if possible.

Note

Do not place the center or rear speakers farther away from the listening position than the front speakers.

Required cords

Audio cords (not supplied)

Two for the 5.1CH OUTPUT FRONT and REAR jacks

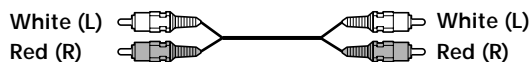

Monaural audio cords (not supplied)

Two for the 5.1CH OUTPUT CENTER and WOOFER jacks



S video cord (supplied)

One for the S VIDEO OUT jacks



Notes

- Do not connect the power cord to an AC outlet or press the POWER switch before completing all connections.
- The cord connectors should be fully inserted into the jacks. Loose connection may cause hum and noise.
- Jacks and plugs of the connecting cords are color-coded as follows:
Red jacks and plugs: Right audio channel
White jacks and plugs: Left audio channel
You can use either red or white cables to connect the center speaker and subwoofer.
- When you connect the component via the DIGITAL OUT OPTICAL or COAXIAL connector using an optical or coaxial digital connecting cord (not supplied), see page 13.

Setups for the player

Some setups are necessary for the player depending on the components to be connected.

Use the setup display or the Control Menu display to change the various settings.

For details on using the setup display, see page 49.

For details on enjoying Digital Cinema Sound, see page 36.

- To enjoy Dolby Digital or MPEG AUDIO surround sound by connecting the player to a receiver (amplifier) with 5.1 ch inputs
Set each speaker position or distance, etc. See page 61.

* Manufactured under license from Dolby Laboratories. “Dolby”, “AC-3”, “Pro Logic” and the double-D symbol  are trademarks of Dolby Laboratories. Confidential Unpublished Works. ©1992-1997 Dolby Laboratories, Inc. All rights reserved.

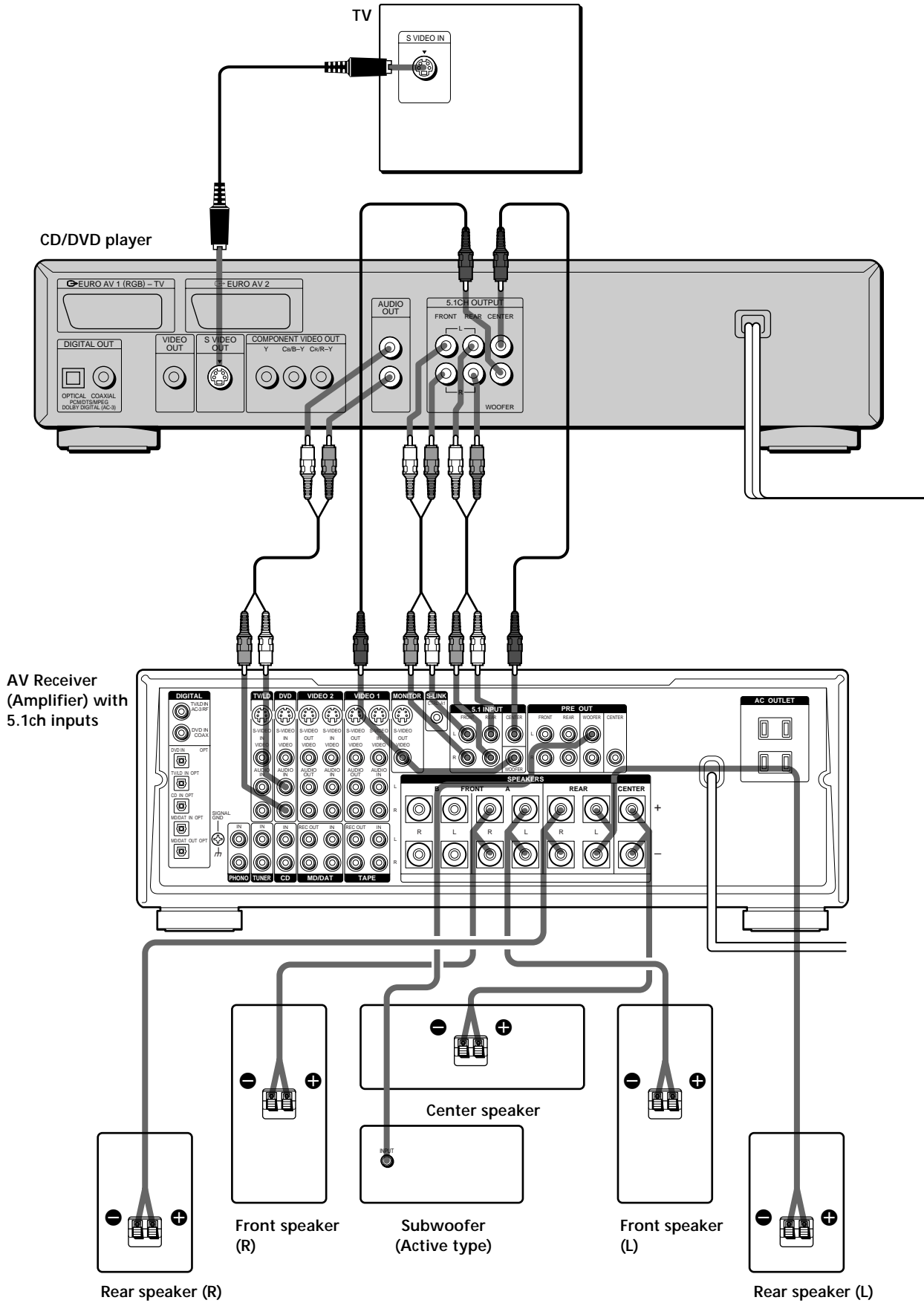

Selecting the Language for On-Screen Display

You can select the language for the setup display, the Control Menu display or the messages displayed on the screen. Default setting is "РУССКИЙ (RUSSIAN)."

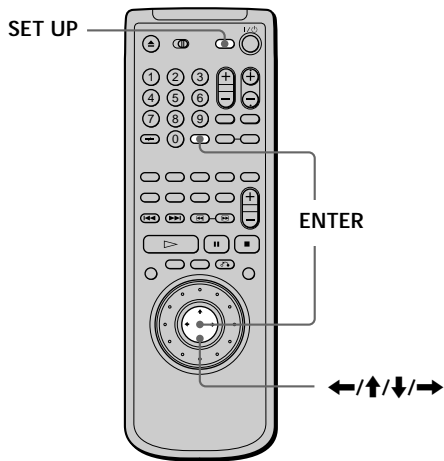

- 1 Press **SET UP** and select "УСТАНОВКА ЯЗЫКОВ (LANGUAGE SETUP)" using **↑/↓**, and then press **ENTER**.



- 2 Select "ЭКРАН (OSD)" using **↑/↓**, then press **→** or **ENTER**.

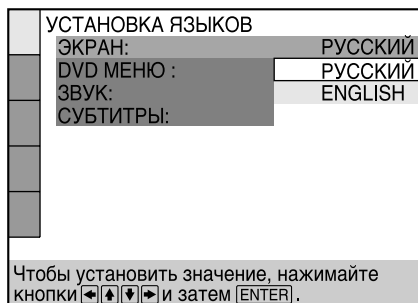

- 3 Select "ENGLISH" using **↑/↓**, then press **ENTER**.

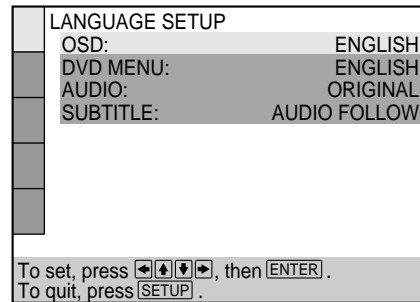

To cancel using the setup display on the way
Press **SET UP**.

Note

The languages you can select are the ones displayed in step 2. For details, see page 52.

Playing Discs

This chapter describes how to play a DVD/CD/VIDEO CD.

This player conforms to the PAL color system. When you play a disc recorded in the NTSC color system, the player outputs the video signal or the setup display etc. in the NTSC color system and the picture may not appear on the TV screen. In this case, open the disc tray and remove the disc.

Playing Discs

Depending on the DVD or VIDEO CD, some operations may be different or restricted. Refer to the instructions supplied with your disc.

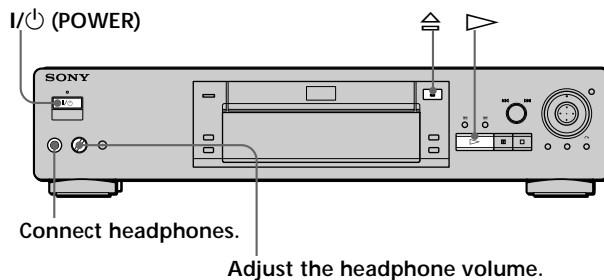

1 Make settings on your TV.

Turn on the TV and select the video input so that you can view the pictures from this player.

When using a receiver (amplifier)

Turn on the receiver (amplifier) and select the appropriate position so that you can listen to the sound from this player.

2 Press I/⏻ (POWER) to turn on the player.

The indicator (red) above the I/⏻ (POWER) button changes to green and the front panel display lights up.

3 Press , and place the disc on the disc tray.

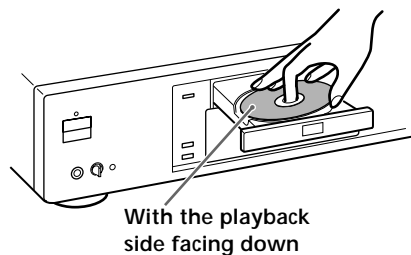

4 Press .

The disc tray closes, and the player starts playback (Continuous Play). Adjust the volume on the TV or the receiver (amplifier).

After following Step 4

■ When playing a DVD

A DVD menu or title menu may appear on the TV screen (see page 21).

■ When playing a VIDEO CD

The menu screen may appear on the TV screen depending on the VIDEO CD. You can play the disc interactively, following the instructions on the menu screen. (PBC Playback, see page 22.)

Playing Discs

 You can turn on the player using the remote
Press I/⏻ (POWER) when the indicator above the I/⏻ (POWER) button on the front panel is lit in red.

Notes

- If you leave the player or the remote in pause or stop mode for 15 minutes, the screen saver image appears automatically. To make the screen saver image go away, press ▷. (If you want to set the screen saver function to off, see page 53.)
- The indicator above the I/⏻ (POWER) button lights up in red when the power is turned off.
- If you don't operate the player or the remote for more than 30 minutes when a disc is not being played, the power is automatically turned off. (Auto Power Off function)

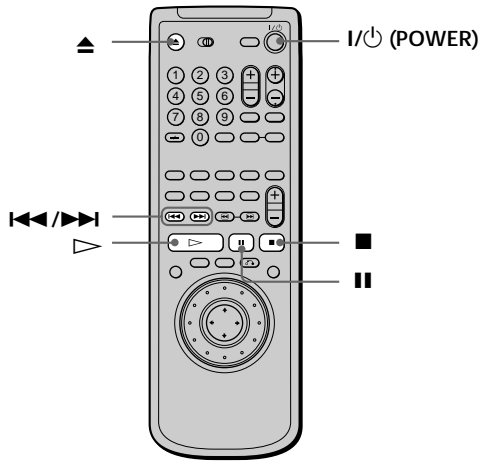
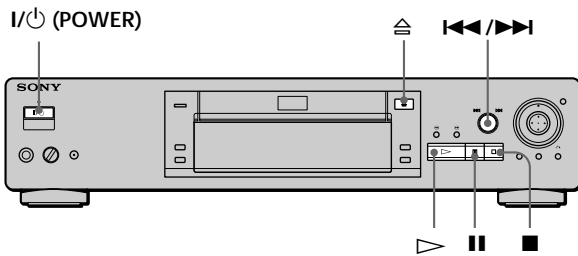

To	Operation
Stop	Press ■.
Pause	Press .
Resume play after pause	Press or ▷.
Go to the next chapter, track or scene in continuous play mode	On the player: Turn ◀◀/▶▶ clockwise to select the chapter. On the remote: Press ▶▶.
Go back to the preceding chapter, track or scene in continuous play mode	On the player: Turn ◀◀/▶▶ counterclockwise to select the chapter. On the remote: Press ◀◀.
Stop play and remove the disc	Press ▲.

You can play discs in various modes such as Program Play using the on-screen menu (Control Menu). For operations of Control Menu, see page 25.

Playing at Various Speeds/Frame by Frame DVD VIDEO CD CD

Using the click shuttle and the JOG button/indicator, you can play back a DVD/CD/VIDEO CD at various speeds or frame by frame. Each time you press JOG, it changes between shuttle mode and jog mode.

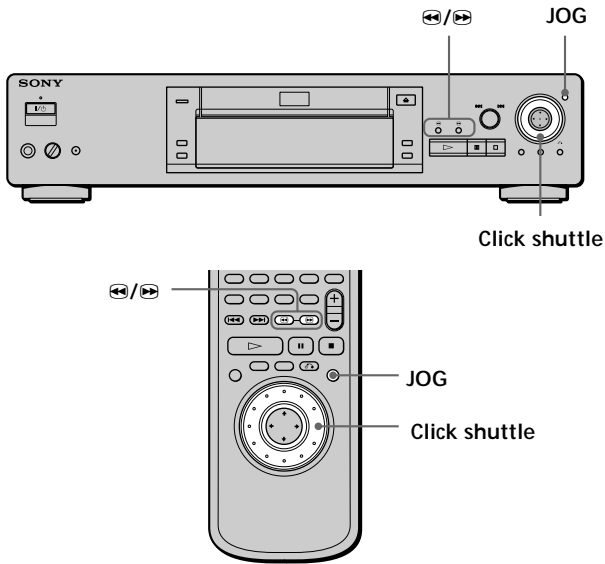

When you play back a CD/VIDEO CD

- 2▶▶ Fast forward (Faster than "1▶▶")
- ↕
- 1▶▶ Fast forward
- ↕
- ×2▶ (about twice the normal speed)*
- ↕
- ▶ (Normal speed)
- ↕
- 1▶ Slow (playback direction)**
- ↕
- 2▶ Slow (playback direction - slower than "1▶")**
- ↕
- || Pause
- ↕
- 1◀◀ Fast rewind
- ↕
- 2◀◀ Fast rewind (Faster than "1◀◀")

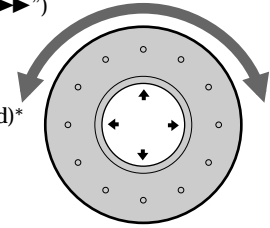

* CD Only
** VIDEO CD Only

If you turn the click shuttle quickly, the playback speed goes to 2▶▶/2◀◀ at once.

To return to continuous play

Press ▷.

To search for the picture using the button
Keep pressing ◀ or ▶. The playback speed is same as 1◀◀ or 1▶▶ when using the click shuttle. When you release the button, the playback speed returns to normal.

Note

Depending on the DVD/VIDEO CD, you may not be able to do some of the operations described.

To change the playback speed (Shuttle mode)

Turn the click shuttle. The playback speed changes depending on the turning direction and angle as follows:

When you play back a DVD

- 2▶▶ Fast forward (about 30 times the normal speed)
- ↕
- 1▶▶ Fast forward (about 10 times the normal speed)
- ↕
- ×2▶ (about twice the normal speed)
- ↕
- ▶ (Normal speed)
- ↕
- 1▶ Slow (playback direction)
- ↕
- 2▶ Slow (playback direction - slower than "1▶")
- ↕
- || Pause
- ↕
- 2◀◀ Slow (opposite direction - slower than "1◀◀")
- ↕
- 1◀◀ Slow (opposite direction)
- ↕
- ×2◀ (about twice the normal speed)
- ↕
- 1◀◀ Fast rewind (about 10 times the normal speed)
- ↕
- 2◀◀ Fast rewind (about 30 times the normal speed)

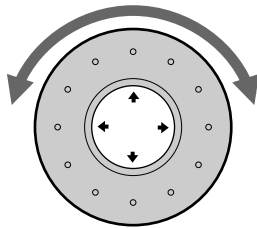

If you turn the click shuttle quickly, the playback speed goes to 2▶▶/2◀◀ at once.

Playing at Various Speeds/Frame by Frame

To play the disc frame by frame changing the playback speed (Jog mode)



- 1 Press JOG.
JOG lights up during jog mode. When you press JOG on the player, it pauses.
- 2 Turn the click shuttle.
Depending on the turning speed, the playback goes to frame-by-frame in the direction that the click shuttle is turned. If you turn the click shuttle with constant speed for a while, the playback speed goes to slow or normal.

To return to Continuous Play

Press ▷.

Notes

- The JOG indicator shows the mode of the corresponding click shuttle. For example, when the JOG indicator on the remote is not lit, the remote click shuttle will remain in the shuttle mode even if the indicator on the player is lit.
- If you don't operate the click shuttle for about 20 seconds after pressing JOG, it returns to shuttle mode on the remote. On the player, it stays in jog mode.

Resuming Playback from the Point Where You Stopped the Disc (Resume Play)

The player stores the point where you stopped the disc and if "RESUME" appears on the front panel display. You can resume playback from that point. As long as you do not open the disc tray, Resume Play is available even if you turn the power off.

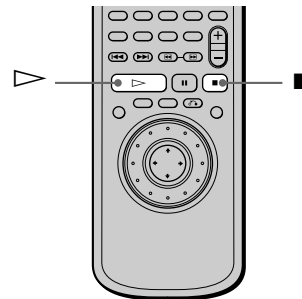
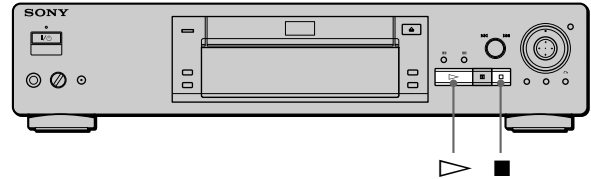

- 1 While playing a disc, press ■ to stop playback. "RESUME" appears in the front panel display and "When playing next time, disc restarts from point you stopped." appears on the TV screen. If "RESUME" does not appear, Resume Play is not available.
 - 2 Press ▷.
The player starts playback from the point where you stopped the disc in Step 1.
-  **To play from the beginning of the disc**
When the playing time appears on the front panel display before you start playing, press ■ to reset the playing time, then press ▷.

Notes

- Resume Play may not be available depending on the DVD.
- Resume Play is not available in Shuffle or Program Play mode.
- Depending on where you stopped the disc, the player may resume playback from a different point.
- The point where you stopped playing is cleared when:
 - you open or close the disc tray
 - you disconnect the AC power cord
 - you change the play mode
 - you start playback after selecting a title, chapter or track
 - you change the settings of “TV TYPE” in “SCREEN SETUP” in the setup display
 - you change the settings of “PARENTAL CONTROL” in “CUSTOM SETUP” in the setup display

Using the Menu for Each DVD

Using the title menu

A DVD is divided into long sections of a picture or a music piece called “titles.” When you play a DVD which contains several titles, you can select the title you want using the title menu.

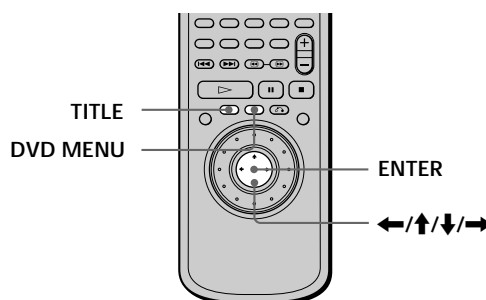
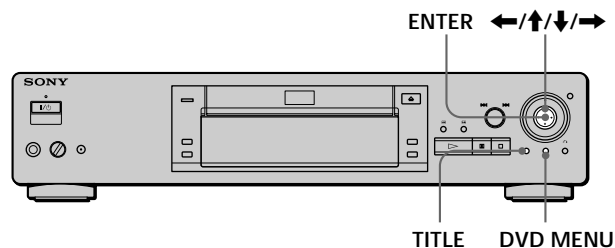

- 1 Press TITLE.**
The title menu appears on the TV screen. The contents of the menu vary from disc to disc.
- 2 Press $\leftarrow/\uparrow/\downarrow/\rightarrow$ to select the title you want to play.**
Depending on the disc, you can use the number buttons to select the title.
- 3 Press ENTER.**
The player starts playing the selected title.

Notes

- Depending on the DVD, you may not be able to select the title.
- Depending on the DVD, a “title menu” may simply be called a “menu” or “title” in the instructions supplied with the disc. “Press ENTER.” may also be expressed as “Press SELECT.”

Using the Menu for Each DVD

Using the DVD menu

Some DVDs allow you to select the disc contents using the menu. When you play these DVDs, you can select the language for the subtitles, the language for the sound, etc., using the DVD menu.

- 1 Press DVD MENU.**
The DVD menu appears on the TV screen. The contents of the menu vary from disc to disc.
- 2 Press ←/↑/↓/→ to select the item you want to change.**
Depending on the disc, you can use the number buttons to select the item.
- 3 To change other items, repeat Step 2.**
- 4 Press ENTER.**

 If you want to select the language for the DVD menu Change the setting using "LANGUAGE SETUP" in the setup display. For details, see page 52.

Note

Depending on the DVD, a "DVD menu" may simply be called a "menu" in the instructions supplied with the disc.

Playing VIDEO CDs with PBC Functions (PBC Playback)

When playing VIDEO CDs with PBC functions (Ver. 2.0 discs), you can enjoy simple interactive operations, operations with search functions, etc.

PBC Playback allows you to play VIDEO CDs interactively, following the menu screen on the TV screen. On this player, you can use the number buttons, ENTER, ◀▶, ↑/↓ and ↻(RETURN) during PBC Playback.

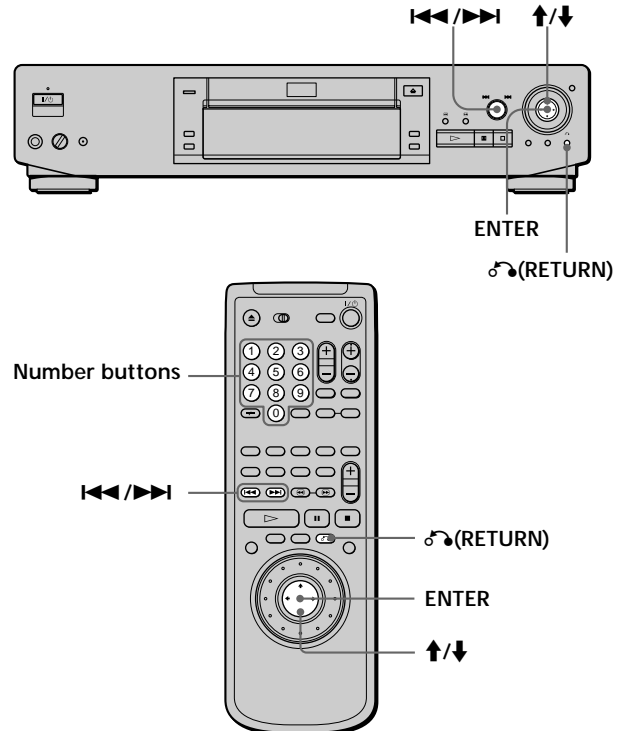

- 1 Start playing a VIDEO CD with PBC functions, following Steps 1 to 4 in "Playing Discs" on page 17.**
- 2 Select the item number you want.**
On the player
Press ↑/↓ to select the item number.
On the remote
Press the number button of the item you want.
- 3 Press ENTER.**
- 4 Follow the instructions on the menu screen for interactive operations.**
Refer to the instructions supplied with the disc, as the operating procedure may differ according to the VIDEO CD.

Going back to the menu screen

Press , , or .

When playing VIDEO CDs with PBC functions PBC playback starts automatically.

To cancel PBC playback of a VIDEO CD with PBC functions and play the disc in Continuous Play mode There are two ways.

- Before you start playing, select the track you want using or , then press ENTER or .
 - Before you start playing, select the track number using the number buttons on the remote, then press ENTER or .
- “Play without PBC” appears on the TV screen and the player starts Continuous Play. You cannot play still pictures such as a menu screen.
- To return to PBC playback, press twice then press .

Note

Depending on the VIDEO CD, “Press ENTER” in Step 3 may be expressed as “Press SELECT” in the instructions supplied with the disc.

Using the Front Panel Display



You can check information about the disc, such as the total number of the titles or the tracks or remaining time, using the front panel display.

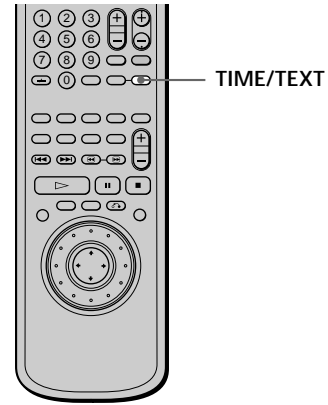

When playing back a DVD

Display information while playing the disc

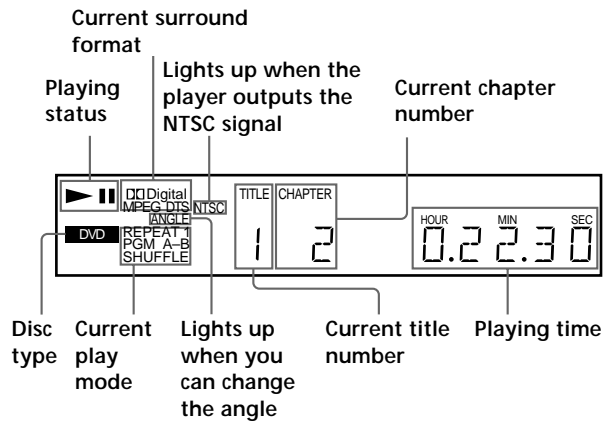

Checking the remaining time

Press TIME/TEXT.

Each time you press TIME/TEXT while playing the disc, the display changes as shown in the following chart.

Using the Front Panel Display

Playing time and number of the current chapter

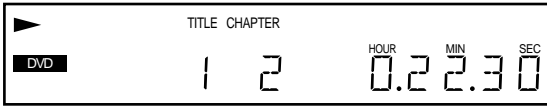

Remaining time of the current chapter

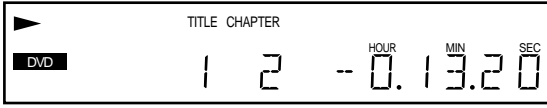

Playing time and number of the current title



Remaining time of the current title



Text or Disc Memo

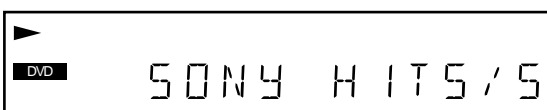

Press TIME/TEXT

Notes

- Depending on the DVD, the chapter number or time may not appear or you may not be able to change the front panel display.
- While you are doing Shuffle Play or Program Play, the playing time of the title and the remaining time of the title are not displayed.

When playing back a CD/VIDEO CD



Display information while playing a disc

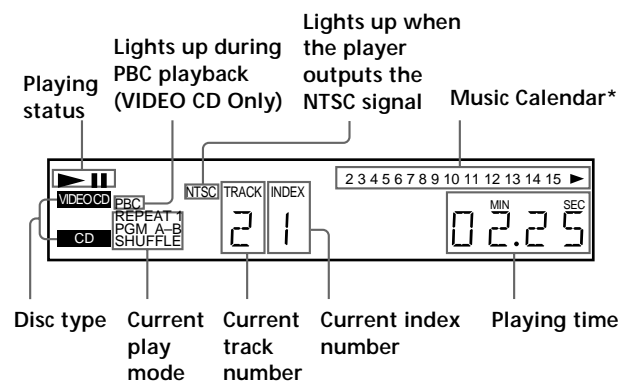

* Track numbers are displayed in the Music Calendar. When there are over 15 tracks, ► is displayed after "15." The track number disappears after playing.



When playing VIDEO CDs with PBC functions

The current scene number is displayed instead of the current track number and the current index number. In this case, the front panel display does not change when you press TIME/TEXT. If a TEXT or Disc Memo is recorded on the disc, the front panel display changes to "Text or Disc Memo" display when you press TIME/TEXT (see page 31).

Checking the remaining time

Press TIME/TEXT.

Each time you press TIME while playing a disc, the display changes as shown in the following chart.

Playing time and number of the current track

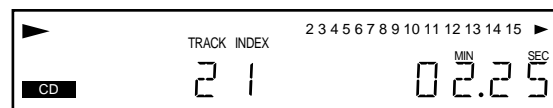

Remaining time of the current track

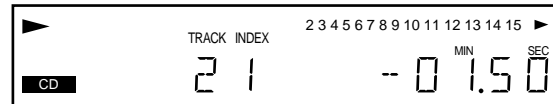

Playing time of the disc

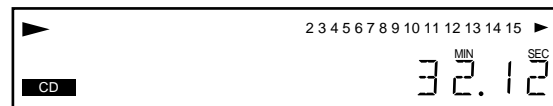

Remaining time of the disc

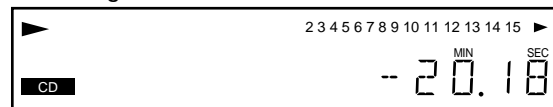

Text or Disc Memo

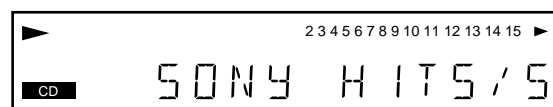

Press TIME/TEXT

Note

While you are doing Shuffle Play, Program Play, or PBC playback, the playing time of the disc and the remaining time of the disc are not displayed.

Using Various Functions with the Control Menu

This chapter describes how to play discs in various modes and how to use the convenient features of the on-screen menu (Control Menu).

Using the Control Menu Display



Using the Control Menu display, you can select the start point, label a disc, change the angles, adjust the picture, set for Digital Cinema Sound, etc.

The items are different depending on the kind of disc.

For details on each Control Menu display item, see pages 28 to 48.

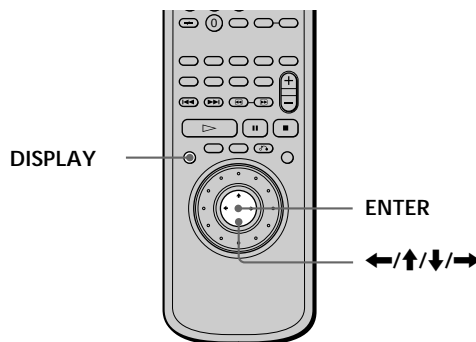

- 1 Press DISPLAY to show the Control Menu display on the TV screen.

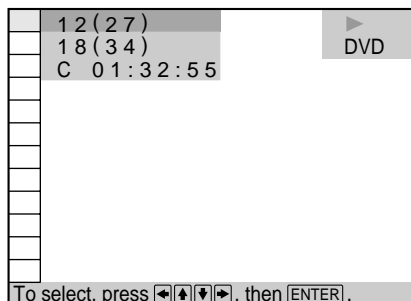

Using the Control Menu Display

- 2 Select the item you want using \uparrow/\downarrow , then press \rightarrow or ENTER.

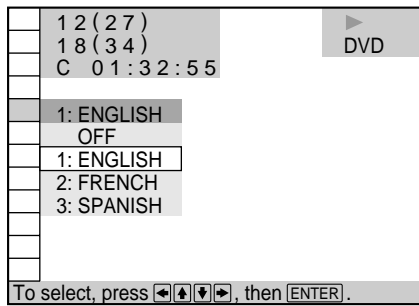
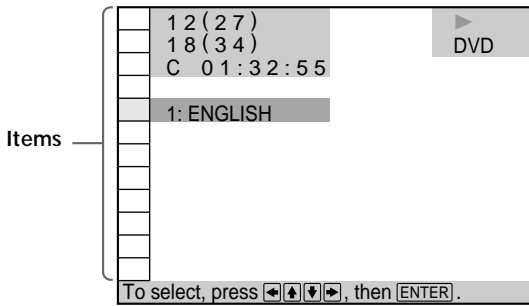

- 3 Select the item you want using \uparrow/\downarrow , then press ENTER.

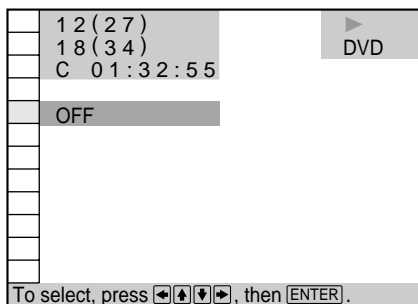
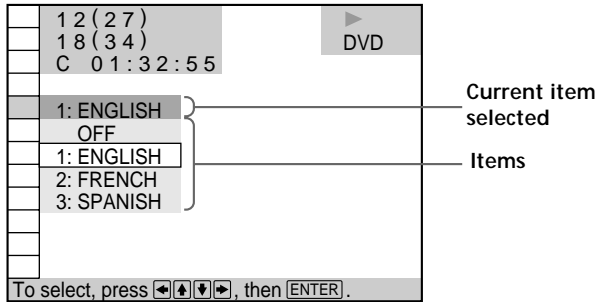

Note

Some Control Menu display items require operations other than selecting the setting. For details on these items, see the relevant pages.

To cancel using the Control Menu display on the way

Press \rightarrow RETURN.

To display other items

Each time you press DISPLAY, the Control Menu display changes as follows:

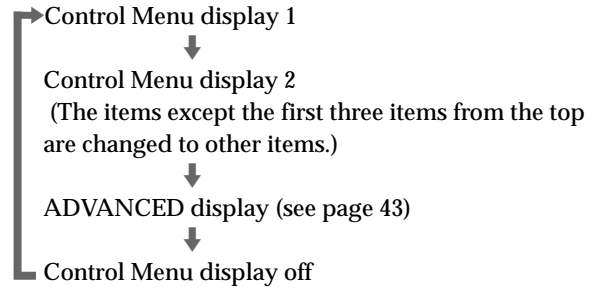

You can display some items using the remote. Some items can be displayed by pressing the button of the remote. In this case, only the item you selected is displayed. For the item and operations using the remote, see the pages of each item.

Control Menu Item List

TITLE (DVD only) (page 28)

CHAPTER (DVD only) (page 28)

TRACK (VIDEO CD/CD only) (page 28)

INDEX (VIDEO CD/CD only) (page 28)

SCENE (VIDEO CD during PBC playback only) (page 28)

You can search by selecting the title/chapter/track/index/scene.

TIME/TEXT (page 29, 30, 31)

TIME/MEMO (page 29, 30, 31)

You can check the playing time and remaining time of the current title/chapter/track and the total remaining time of the disc.

You can search by inputting the time code.

You can check the DVD TEXT or CD TEXT of the disc on the TV screen and the front panel display. When the disc is a VIDEO CD or the DVD TEXT or CD TEXT is not recorded on the disc, you can label the disc as a Disc Memo and check it.

AUDIO (page 33)

With DVDs recorded with multilingual sounds, you can select the language you want while playing the DVD. With multiplex CDs or VIDEO CDs, you can select the sound from the right or left channel and listen to the sound of the selected channel through both the right and left speakers.

SUBTITLE (DVD only) (page 34)

With DVDs on which multilingual subtitles are recorded, you can change the subtitle language whenever you want while playing the DVD, and turn it on or off whenever you want.

ANGLE (DVD only) (page 35)

With DVDs on which various angles (multi-angles) are recorded, you can change the angles on the scene for which multi-angles are recorded.

VIRTUAL 3D SURROUND (page 36)

Select the mode to enjoy multi-channel surround sound such as Dolby Digital and MPEG.

Even if you connect only front speakers, Virtual Enhanced Surround (VES) lets you enjoy 3D sound by using 3D sound imaging to create virtual rear speakers from the sound of the front speakers (L, R) without using actual rear speakers.

When you connect 2 front speakers and 2 rear speakers, you can use the 3D sound imaging to shift the sound of the rear speakers away from the actual speaker position (VIRTUAL REAR SHIFT) or to create 3 sets of virtual rear speakers from 1 set of actual rear speakers (VIRTUAL MULTI REAR).

You can feel the more effective 3D sound when you connect a receiver (amplifier) with 5.1 channel inputs, 2 front speakers, 2 rear speakers, 1 center speaker and 1 subwoofer.

PROGRAM (page 38)

You can play the contents of the disc in the order you want by arranging the order of the titles, chapters or tracks on the disc to create your own program.

SHUFFLE (page 40)

You can have the player "shuffle" titles, chapters or tracks and play them in a random order. The playing order may differ from the previous "shuffling."

REPEAT (page 41)

You can play all the titles/tracks on a disc or a single title/chapter/track repeatedly.

A-B REPEAT (page 41)

You can play a specific portion of a title, chapter, or track repeatedly.

ADVANCED (DVD only) (page 43)

You can check the play information about the bit rate, bit rate history or the position where the disc is played (layer).

DNR (DVD/VIDEO CD only) (page 45)

You can make the picture clearer by reducing the picture noise.

VIDEO EQ (DVD/VIDEO CD only) (page 45)

You can adjust the video output of the DVD or VIDEO CD from the player, not from the TV, to obtain the picture quality you want.

ANGLE VIEWER (DVD only) (page 47)

With DVDs on which various angles (multi-angles) for a scene are recorded, you can display all the angles recorded on the disc on the same screen, and start playback in continuous mode at the chosen angle directly.

Control Menu Item List

STROBE PLAYBACK (DVD/VIDEO CD only) (page 47)

You can display 9 consecutive sections of the disc on the screen. In this case, the sections show still images.

TITLE VIEWER (DVD only) (page 48)

CHAPTER VIEWER (DVD only) (page 48)

TRACK VIEWER (VIDEO CD only) (page 48)

You can check the titles, chapters and tracks of the disc on the screen divided in 9 sections, and start playback from the chosen title, chapter or track.

BOOKMARK (DVD/VIDEO CD only) (page 48)

You can have the player store specific portions of the disc in memory and play them immediately whenever you want without the need to search.

Searching for the Title/Chapter/Track/Index/Scene



You can search by selecting the title/chapter/track/index/scene.

Select "TITLE," "CHAPTER," "TRACK", "INDEX" or "SCENE" after pressing DISPLAY.

When you play back a DVD, "TITLE" and "CHAPTER" are displayed.

When you play back a VIDEO CD/CD, "TRACK" and "INDEX" are displayed. When you play back a VIDEO CD with PBC functions, "SCENE" is displayed.

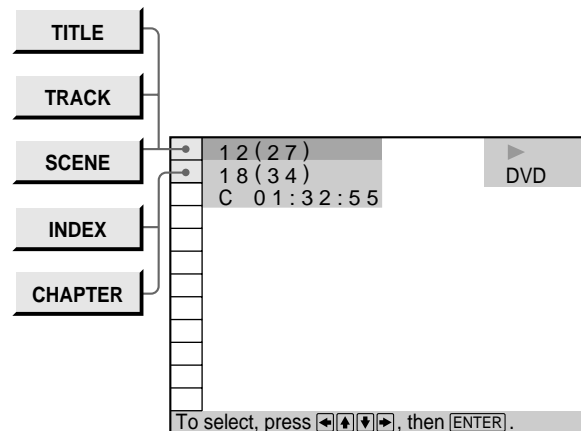

- 1 Select "TITLE," "CHAPTER," "TRACK," "INDEX" or "SCENE" using **↑/↓**.

"** (***)" is highlighted. (** means optional number in this manual.) Number in parentheses indicate the total number of titles, chapters, tracks, indexes or scenes.

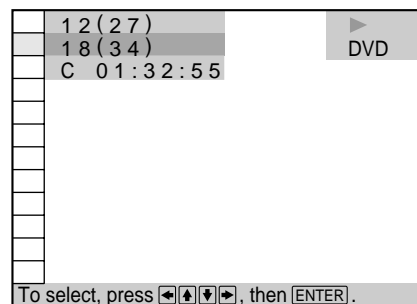

2 Press **→** or **ENTER**.

"** (***)" is changed to "-- (***)".

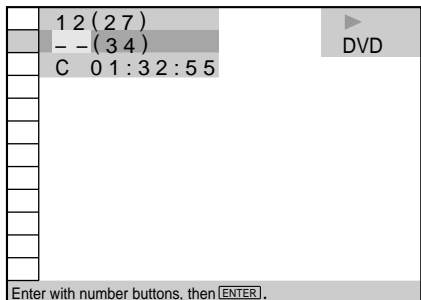

3 Select the number of the title, chapter, track, index or scene you want to search for using the number buttons, then press **ENTER**.

The player starts searching. To cancel the number, press **CLEAR** before pressing **ENTER**.

To cancel selecting

Press **↩** RETURN.

Notes

- The number of titles, chapters or tracks displayed is that of the titles, chapters or tracks recorded on a disc.
- The index numbers are not displayed during PBC playback of VIDEO CDs.

Checking the Playing Time and Remaining Time



You can check the playing time and remaining time of the current title /chapter/track and the total remaining time of the disc.

Press **DISPLAY**. Then press **TIME/TEXT** on the remote to change the time information.

You can also check the **DVD TEXT**, **CD TEXT** and **Disc Memo**, and label the **Disc Memo**. See page 31.

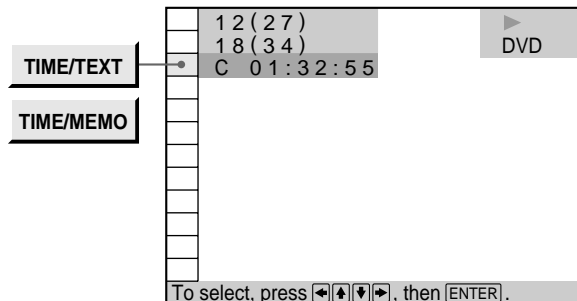

When playing a DVD

■TIME/TEXT or TIME/MEMO

- C ***:***:***: Playing time of the current chapter
- C -***:***:***: Remaining time of the current chapter
- T ***:***:***: Playing time of the current title
- T -***:***:***: Remaining time of the current title

When playing a VIDEO CD (during PBC playback)

■TIME/MEMO

- ***:***: Playing time of the current scene

When playing a VIDEO CD (in continuous play) or CD

■TIME/TEXT or TIME/MEMO

- T ***:***: Playing time of the current track
- T -***:***: Remaining time of the current track
- D ***:***: Playing time of the current disc
- D -***:***: Remaining time of the current disc



You can display "TIME/TEXT" or "TIME/MEMO" display using the remote.

Press **TIME/TEXT** on the remote. Each time you press the button, the time information changes.

Selecting a Start Point Using the Time Code



You can search by inputting the time code.
Select "TIME/TEXT" or "TIME/MEMO" after pressing DISPLAY.
The time code corresponds to the approximate actual playing time. For example, to search for a scene 2 hours 30 minutes 20 seconds past the beginning, input 2:30:20.

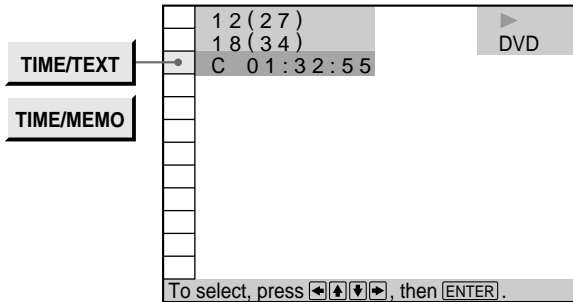

- 3 Input the time code using the number buttons, then press ENTER.
The player starts searching. To cancel the number, press CLEAR before pressing ENTER.

To cancel inputting

Press RETURN.

Note

When you input the time code, input the playing time of the title.

- 1 Select "C * * : * * : * * " (playing time of the current chapter) when playing a DVD.

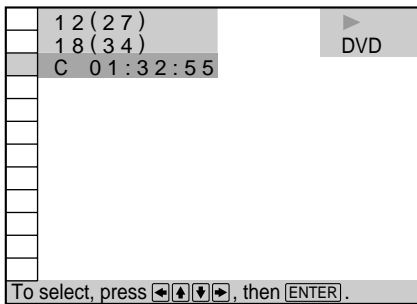

- 2 Press or ENTER.
Time code changes to "T--:--:--".

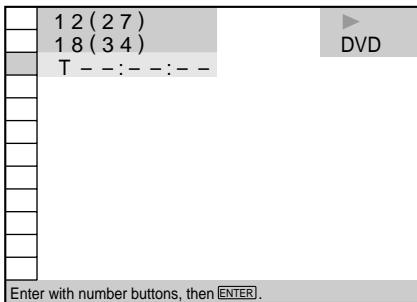

Checking the Information of the Disc



You can check the DVD TEXT or CD TEXT of the disc on the TV screen and the front panel display. When the disc is a VIDEO CD or the DVD TEXT or CD TEXT is not recorded on the disc, you can label the disc as a Disc Memo and then check it.

DVD TEXT and CD TEXT are information recorded on the disc which you cannot change.

Press DISPLAY. If the disc has DVD TEXT or CD TEXT recorded, "TIME/TEXT" appears. If a Disc Memo can be input in the disc, "TIME/MEMO" appears. Press TIME/TEXT on the remote until DVD/CD TEXT or Disc Memo is displayed.

The information is displayed at the bottom of the display.

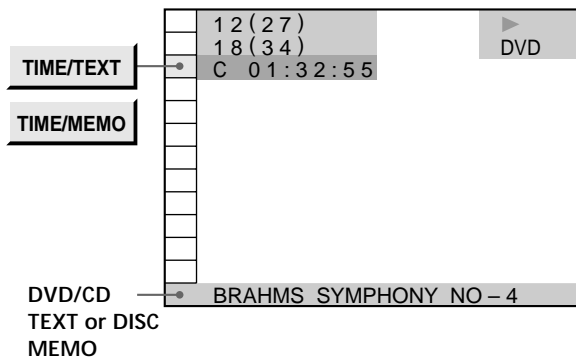

You can display "TIME/TEXT" or "TIME/MEMO" display using the remote. Press TIME/TEXT on the remote. To display DVD/CD TEXT or Disc Memo, press TIME/TEXT until DVD/CD TEXT or Disc Memo is displayed.

Note

The DVD TEXT only in English is displayed.

Labeling discs (Disc Memo)

When the DVD TEXT or CD TEXT is not recorded on the disc, you can change the name of the disc by labeling it on the on-screen display and put a personal title on the disc. You can input up to 20 characters per disc each.

You can also have the player display the Disc Memo each time you select the disc. The Disc Memo can be anything you like, such as a title, musician's name, category or date of purchase.

- 1 Select "DISC MEMO INPUT" in "TIME/TEXT" or "TIME/MEMO"

The DISC MEMO INPUT display appears.

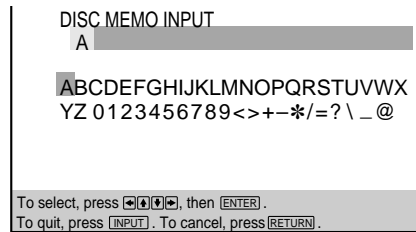
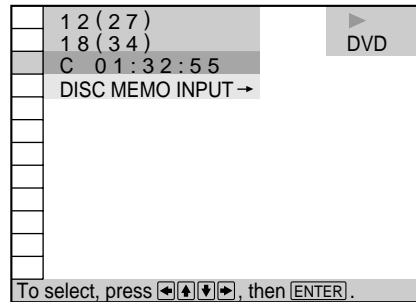

- 2 Select the character by pressing ←/↑/↓/→ or by turning the click shuttle.

The selected character changes color.

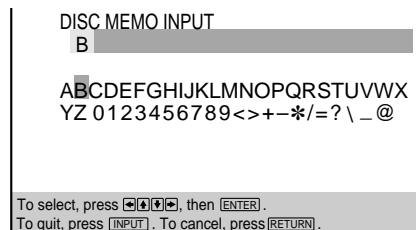

Checking the Information of the Disc

3 Press ENTER.

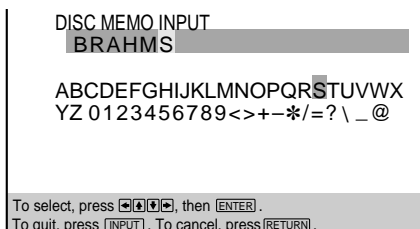

Note

You can label up to 200 discs. When you have the player store over 200 discs in memory, each new Disc Memo erases the oldest Disc Memo from those first stored.

4 Repeat steps 2 and 3 to input other characters.

5 When you have entered all the characters for the disc label, press INPUT on the remote. The disc label is stored.

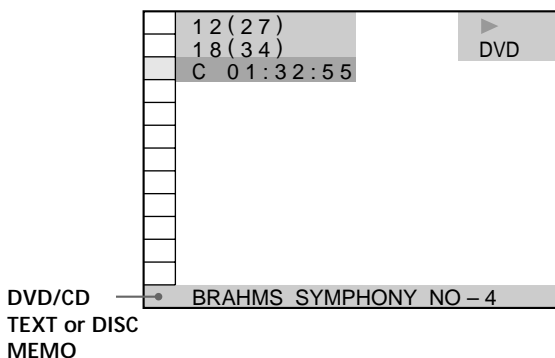

To correct the characters

- To erase the characters:
 - 1 Move the cursor to the character you want to erase by pressing **◀◀/▶▶**.
 - 2 Press CLEAR.
- To insert or overwrite the characters:
 - 1 Move the cursor to the character you want to correct by pressing **◀◀/▶▶**.
 - 2 Select the correct character by pressing **←/↑/↓/→** or by turning the click shuttle.
 - 3 To insert the character, press ENTER. To overwrite, don't press ENTER but move the cursor by pressing **▶▶**.

 You can display the Disc Memo input display using the remote. Press INPUT on the remote.

Changing the Sounds



With DVDs recorded with multilingual sounds, you can select the language you want while playing the DVD. With multiplex CDs or VIDEO CDs, you can select the sound from the right or left channel and listen to the sound of the selected channel through both the right and left speakers. In this case, the sound loses the stereo effect. For example, with a disc containing a song, the right channel may output the vocals and the left channel may output the instrumental. If you only want to hear the instrumental, you can select the left channel and hear it from both speakers.

Select "AUDIO" after pressing DISPLAY.

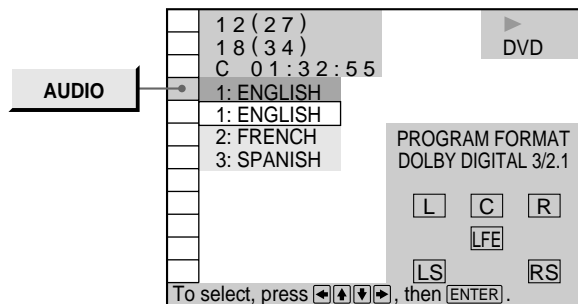

AUDIO

When playing a DVD

Select the language. The languages you can select are different depending on the DVD. When 4 digits are displayed, they represent the language code. Select the language code from the list on page 72.

When playing a VIDEO CD or a CD

- **STEREO** : The standard stereo sound
- 1/L : The sound of the left channel (monaural)
- 2/R : The sound of the right channel (monaural)

You can display "AUDIO" display using the remote. Press AUDIO on the remote.

Notes

- Depending on the DVD, you may not be able to change the languages even if multilingual sounds are recorded on the DVD.
- While playing the CD/VIDEO CD, the standard stereo playback will be resumed when:
 - you open or close the disc tray
 - you turn the power off
- While playing the DVD, the sound may be changed when:
 - you open or close the disc tray
 - you change the title
- If the language is displayed as a 4 digit number, refer to the language code list on page 72.

Displaying the audio information of the disc

When you select "AUDIO," the playing channels are displayed on the screen.

In Dolby Digital format, the signals from monaural to 5.1 channels can be recorded on a DVD. Depending on the DVD the number of the recorded channels may be different.

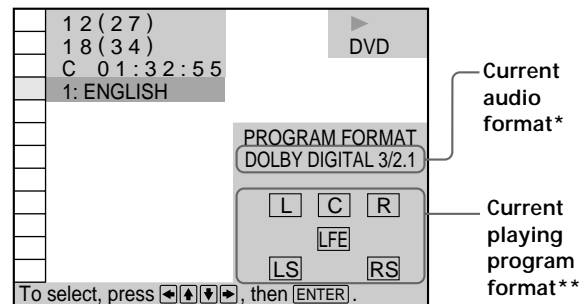

* "PCM," "DTS," "DOLBY DIGITAL" or "MPEG" is displayed. In "DOLBY DIGITAL" case, the channels in the playing track are displayed by number as follows:

The case of Dolby Digital 5.1 ch:

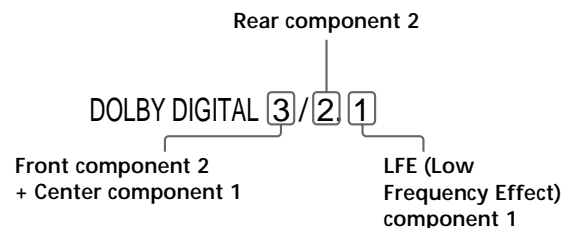

** The letters in the program format display mean the following:

- L: Front (L)
- R: Front (R)
- C: Center (monaural)
- LS: Rear (L)
- RS: Rear (R)
- S: Rear (monaural) – the rear component of the Dolby Surround processed stereo signal and the Dolby Digital signal.
- LFE: LFE (Low Frequency Effects)

Changing the Sounds

The display examples are as follows:

•PCM (stereo)

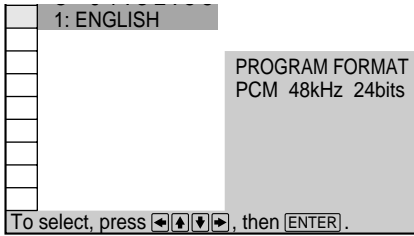

•Dolby Surround

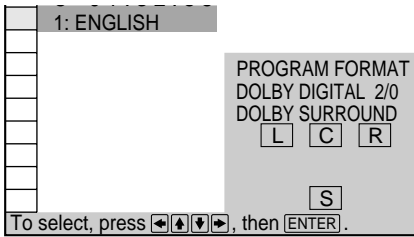

•Dolby Digital 5.1ch

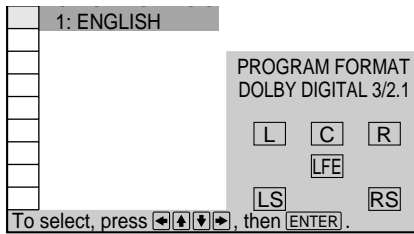

•DTS

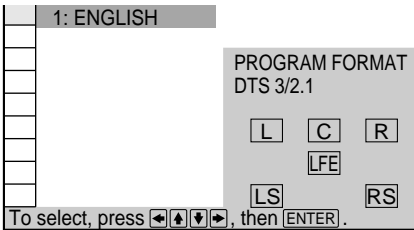

•MPEG

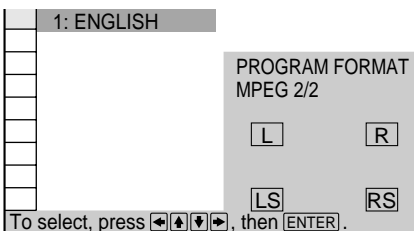

You can find Dolby Surround-encoded software by looking at the packaging

Use discs with the logo. In order to enjoy Dolby Digital playback you must use discs bearing this logo.

Displaying the Subtitles



With DVDs on which subtitles are recorded, you can turn the subtitles on and off whenever you want while playing the DVD.

With DVDs on which multilingual subtitles are recorded, you can change the subtitle language whenever you want while playing the DVD, and turn it on or off whenever you want. For example, you can select the language you want to master and turn the subtitles on for better understanding.

Select "SUBTITLE" after pressing DISPLAY.

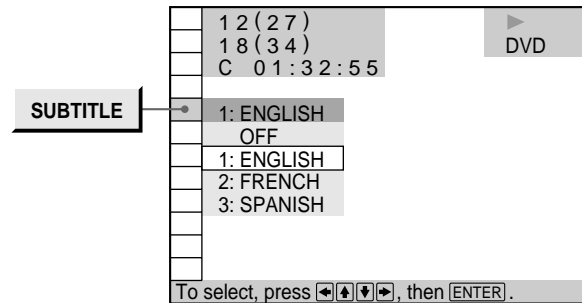

■SUBTITLE

Select the language. The languages you can select are different depending on the DVD. When 4 digits are displayed, they indicate the language code. Select the language code from the list on page 72.

You can display the "SUBTITLE" display by using the remote. Press SUBTITLE on the remote. Each time you press the button, the item changes.

Notes

- When playing a DVD on which no subtitles are recorded, no subtitles appear.
- Depending on the DVD, you may not be able to turn the subtitles on even if they are recorded on it.
- Depending on the DVD, you may not be able to turn the subtitles off.
- If the language is displayed as a 4-digit number, refer to the language code list on page 72.
- The type and number of languages for subtitles vary from disc to disc.
- Depending on the DVD, you may not be able to change the subtitles even if multilingual subtitles are recorded on it.
- While playing the DVD, the subtitle may change when:
 - you open or close the disc tray
 - you change the title

Changing the Angles DVD

With DVDs on which various angles (multi-angles) for a scene are recorded, you can change the angles. For example, while playing a scene of a train in motion, you can display the view from either the front of the train, the left window of the train or from the right window without having the train's movement interrupted. Select "ANGLE" after pressing DISPLAY. When the angles can be changed, the indicator of the "ANGLE" lights in green.

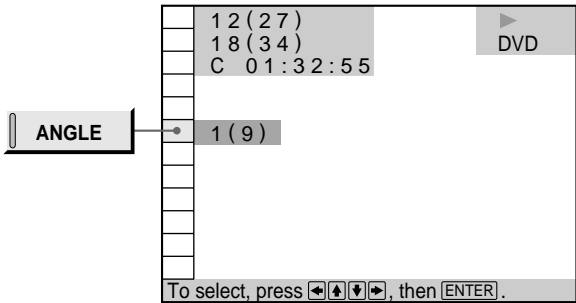

1 Select "ANGLE."

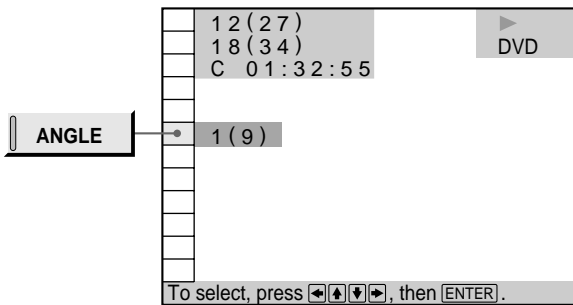

2 Press →.

The number of the angle changes to "-." The number in parentheses indicates the total number of angles.

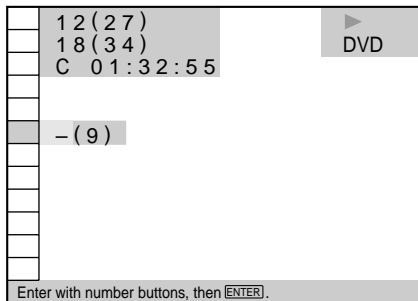

3 Select the number of the angles using the number buttons or ↑/↓, then press ENTER.

The angle is changed to the selected angle.

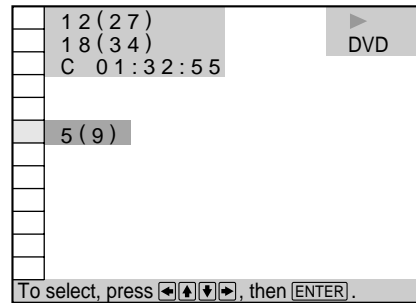

Notes

- The number of angles varies from disc to disc or from scene to scene. The number of angles that can be changed on a scene is that of angles recorded for that scene.
- Depending on the DVD, you may not be able to change the angles even if multi-angles are recorded on the DVD.

You can specify the angle beforehand

Specify the angle when "ANGLE" is not displayed on the front panel display. When a scene on which multi-angles are recorded comes, the angle is automatically selected.

You can select the angle using the remote

Press ANGLE on the remote. Each time you press the button, the angle changes.

You can display different angles simultaneously (ANGLE VIEWER)

You can display all the angles recorded on the disc on the same screen, and start playback in continuous mode from the chosen angle directly. The angles are displayed on a screen divided in 9 sections. For details, see page 47.



Select the mode to enjoy multi channel surround sound such as Dolby Digital and MPEG. Even if you connect only front speakers, Virtual Enhanced Surround lets you enjoy 3D sound by using 3D sound imaging to create virtual rear speakers from the sound of the front speakers (L, R) without using actual rear speakers.

When you connect 2 front speakers and 2 rear speakers, use 3D sound imaging to shift the sound of the rear speakers away from the actual speaker position (VIRTUAL REAR SHIFT) or to create 3 sets of virtual rear speakers from 1 set of actual rear speakers (VIRTUAL MULTI REAR).

You can feel the more effective 3D sound when you connect a receiver (amplifier) with 5.1 channel inputs, 2 front speakers, 2 rear speakers, 1 center speaker and 1 subwoofer.

Select "VIRTUAL 3D SURROUND" after pressing DISPLAY. When you select the item except "OFF," the indicator of the "VIRTUAL 3D SURROUND" lights in green.

Note

To enjoy the original Dolby Digital sound through the 5.1CH OUTPUT connectors, set each speaker position or distance, etc. For details on setting each speaker, see page 61.

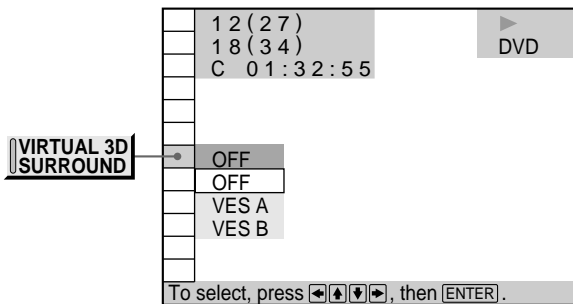

■VIRTUAL 3D SURROUND

Select the desired item. For details on each item, see "Effects of each item."

- OFF
- VES A*
- VES B*
- NORMAL SURROUND
- ENHANCED SURROUND
- VIRTUAL REAR SHIFT
- VIRTUAL MULTI REAR

* These settings also effect the output from the AUDIO OUT connector.

Note

The items displayed are different depending on the settings of "SPEAKER SETUP." (page 61).

You can select only "OFF," "VES A" or "VES B" when you play back a DVD and set "NONE" in "REAR" in "SIZE" under "SPEAKER SETUP" in the set up display.

Effects of each item

OFF

Outputs all channel signals recorded on the disc. For example, outputs 2-channel signals for stereo sound of the CD or 5-channel signals for Dolby Digital sound of the DVD. When you connect fewer than 5 (+1) speakers, the player distributes the output signal for the missing speaker to other speakers appropriately.

VES (Virtual Enhanced Surround) A

Uses 3D sound imaging to create virtual rear speakers from the sound of the front speakers (L, R) without using actual rear speakers. The virtual speakers are reproduced as shown in the illustration below.

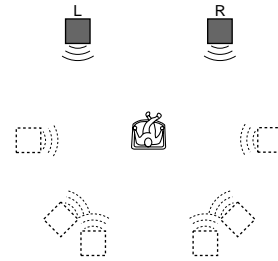

VES (Virtual Enhanced Surround) B

Uses 3D sound imaging to create virtual rear speakers from the sound of the front speakers (L, R) without using actual rear speakers. The virtual speakers are reproduced as shown in the illustration below.

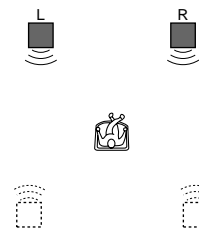

NORMAL SURROUND

Software with 2 channel audio signals, is decoded with Dolby Pro Logic to create surround effects.

ENHANCED SURROUND

Provides a greater sense of presence from Pro Logic source with monaural rear channel sound. Produces a stereo like effect in the rear channels.

VIRTUAL REAR SHIFT

Uses 3D sound imaging to shift the sound of the rear speakers away from the actual speaker position. The virtual speakers are reproduced as shown in the illustration below. The shift position differs according to the setting of the rear speaker position.

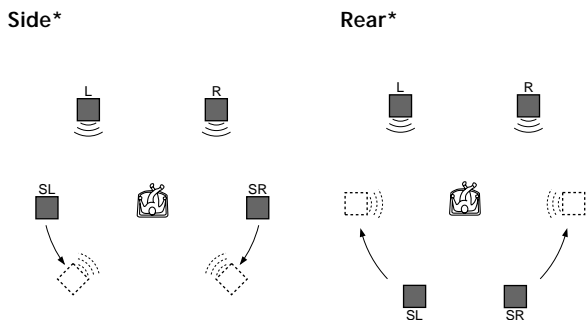

VIRTUAL MULTI REAR

Uses 3D sound imaging to create an array of virtual rear speakers from a single pair of actual rear speakers. The virtual speakers are reproduced as shown in the illustration below. The position of the virtual rear speakers differs according to the setting of the rear speaker position.

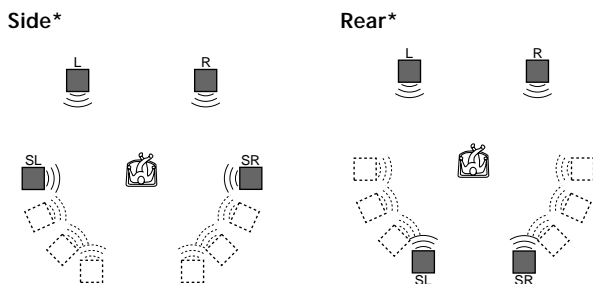

* See page 61 for details on how to set the rear speaker position.

- L: Front speaker (left)
- R: Front speaker (right)
- SL: Rear speaker (left)
- SR: Rear speaker (right)
- ⊞: Virtual speaker

Notes

- Some discs do not have rear sound. In this case, you cannot get the 3D surround effect.
- When you select an item, the sound cuts off for a moment.
- When the playing signal does not contain the surround component, the effects may be difficult to hear even if you select "VES A" or "VES B."
- If you connect the front speakers only, "NORMAL SURROUND," "ENHANCED SURROUND," "VIRTUAL REAR SHIFT" and "VIRTUAL MULTI REAR" cannot be selected.
- The sound does not come from the rear speakers when you set "VIRTUAL 3D SURROUND" to "VES A" or "VES B" in the Control Menu display even if you have connected rear speakers.
- Set the front speakers to form an equilateral triangle including the listening position, or the effects may be difficult to hear even if you select "VES A" or "VES B."
- In case that the player outputs the signal from DIGITAL OUT (OPTICAL, COAXIAL), the surround effect will be heard only when you set "DOLBY DIGITAL" to "D-PCM," and "MPEG" to "PCM" in "AUDIO SETUP."
- When you play sound tracks with 96 kHz sampling frequency, be sure to select "OFF," or the output signals will be converted to 48 kHz (sampling frequency). (Except when the player outputs the audio signal from DIGITAL OUT (OPTICAL, COAXIAL))
- When you connect a center speaker and a subwoofer, you can also hear the sound from the center speaker and the subwoofer. When you select "VES A" or "VES B," the player does not output the sound from the center speaker.
- When you select "VES A" or "VES B," set the surround settings of the connected units such as the amplifier to OFF.

 You can select the item of "VIRTUAL 3D SURROUND" using this button
Press VIRTUAL 3D SURROUND on the player. Each time you press the button, the item changes.

Creating Your Own Program (Program Play)



DVD

VIDEO CD

CD

You can play the contents of the disc in the order you want by arranging the order of the titles, chapters or tracks on the disc and create your own program. One program can be restored in the player and contain up to 99 titles, chapters and tracks.

Select "PROGRAM" after pressing DISPLAY. When you select "ON", the indicator of the "PROGRAM" lights in green.

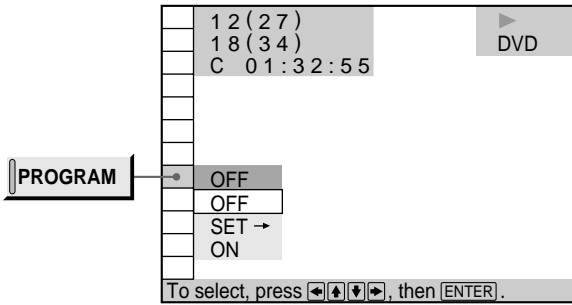

PROGRAM

- OFF: plays normal.
- SET ->: allows you to create your own program.
- ON: plays Program Play.

Creating the program

- 1 Select "SET ->" in "PROGRAM".
The programming display appears.

"TRACK" is displayed when you play a VIDEO CD or a CD.

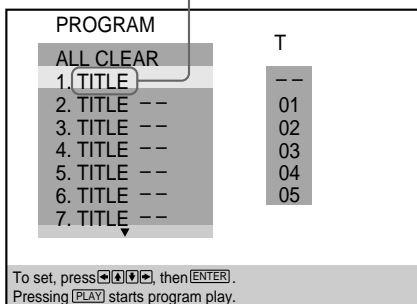

- 2 Press **→**.

"01" is highlighted. It is ready to set the first title or track for program.

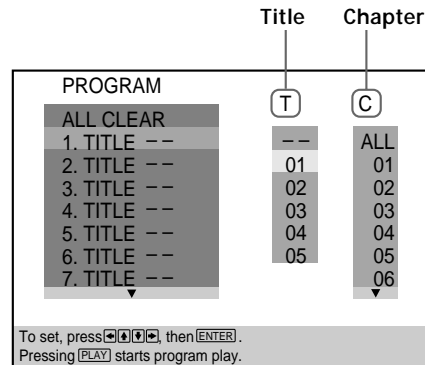

- 3 Select the title, chapter or track you want to program using **↑/↓**, then press **ENTER**.

For example, select title or track 2.

(You can also use the number buttons and ENTER button to select. In this case, the selected number is displayed on the screen.)

When playing a DVD

When both titles and chapters are recorded on the disc, select the title, then the chapter.

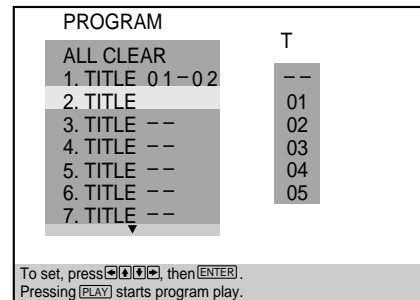
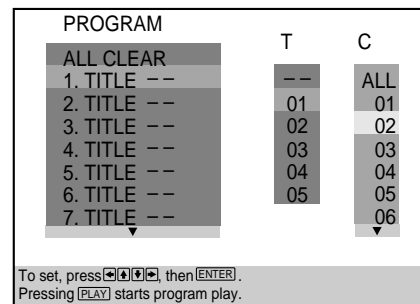

- **When playing a VIDEO CD or CD**
Select the track you want to program.

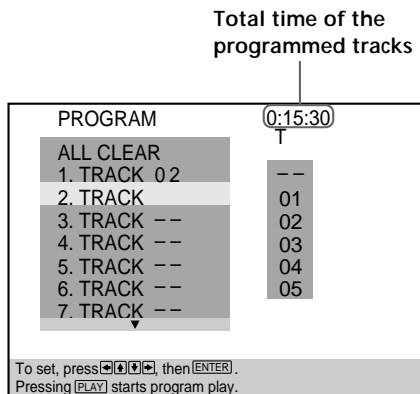

- 4** To program other titles, chapters or tracks, repeat Step 3.

The programmed titles, chapters or tracks are displayed from 2 in order.

- 5** Press \triangleright to start Program Play.

To cancel Program Play

Press CLEAR.

To cancel programming

Press PROGRAM.

To change programming

- In Step 2, select the program number of the title, chapter or track you want to change using \uparrow/\downarrow .
- Follow Step 3 for new programming.

To cancel the programmed order

To cancel all the titles, chapters or tracks in the programmed order, select "ALL CLEAR" in Step 2. To cancel the selected program, select the program using \uparrow/\downarrow in Step 2 then press CLEAR, or select "--" in Step 3 then press ENTER.

💡 The program remains even after the Program Play ends. When you press \triangleright , you can play the same program again.

💡 You can do Repeat Play or Shuffle Play of the programmed titles, chapters or tracks.

During Program Play, press REPEAT or SHUFFLE. Or set "REPEAT" or "SHUFFLE" to "ON" in the Control Menu display.

💡 You can display "PROGRAM" display using the remote. Press PROGRAM.

Notes

- The number of titles, chapters or tracks displayed are that of the titles, chapters or tracks recorded on a disc.
- The program is canceled when:
 - you open or close the disc tray
 - you turn the power off
- You may not be able to do Program Play depending on the DVD.
- While you are doing PBC playback, you cannot set a program unless you stop playback once.

Playing in Random Order (Shuffle Play)



DVD

VIDEO CD

CD

You can have the player “shuffle” titles or tracks and play them in a random order. The playing order may differ from the previous “shuffling.”

Select “SHUFFLE” after pressing DISPLAY. When you select “ON”, the indicator of the “SHUFFLE “ lights in green.

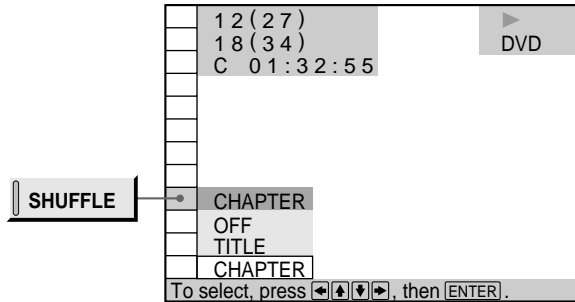

■ SHUFFLE

Selects the setting of Shuffle Play.

When playing a DVD and when Program Play is set to OFF

- **OFF**: does not play a disc in random order.
- **TITLE**: has the player “shuffle” titles and play in a random order.
- **CHAPTER**: has the player “shuffle” chapters and play in a random order.

When playing a VIDEO CD, CD or DVD (when Program Play is set to ON)

- **OFF**: does not play a disc in random order.
- **ON**: has the player “shuffle” titles or tracks and play in a random order.

When playing a VIDEO CD or CD (when Program Play is set to OFF)

- **OFF**: does not play a disc in random order.
- **TRACK**: has the player “shuffle” tracks and play in a random order.

To cancel Shuffle Play

Press CLEAR.



You can set Shuffle Play during stop

After selecting the item of “SHUFFLE,” press \triangleright .

The player starts Shuffle Play.



You can display the “SHUFFLE” display by pressing the button

Press SHUFFLE.

Notes

- Shuffle Play is canceled when:
 - you open or close the disc tray
 - you turn the power off
- You may not be able to do Shuffle Play depending on the DVD.
- Up to 200 chapters in a disc can be played in a random order when “CHAPTER” is selected.

Playing Repeatedly (Repeat Play)



DVD

VIDEO CD

CD

You can play all the titles/tracks on a disc or a single title/chapter/track.

In Shuffle or Program Play mode, the player repeats the titles or tracks in the shuffled or programmed order.

You cannot do Repeat Play during PBC playback of VIDEO CDs (page 22).

You may not be able to do Repeat Play depending on the DVD.

Select "REPEAT" after pressing DISPLAY. When you do not select "OFF," the indicator of the "REPEAT" lights in green.

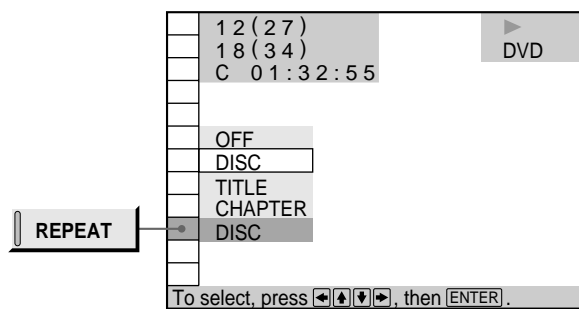

REPEAT

Selects the setting of Repeat Play.

When playing a DVD and when Program Play and Shuffle Play are set to OFF

- **OFF:** does not play repeatedly.
- **DISC:** repeats all the titles.
- **TITLE:** repeats the current title on a disc.
- **CHAPTER:** repeats the current chapter.

When playing a VIDEO CD/CD and when Program Play and Shuffle Play are set to OFF

- **OFF:** does not play repeatedly.
- **DISC:** repeats all the tracks on a disc.
- **TRACK:** repeats the current track.

When Program Play or Shuffle Play is set to ON

- **OFF:** does not play repeatedly.
- **ON:** repeats Program Play or Shuffle Play.

To cancel Repeat Play

Press CLEAR.



You can set Repeat Play during stop

After selecting the item of "REPEAT," press \triangleright .
The player starts Repeat Play.



You can display the "REPEAT" display by pressing the button
Press REPEAT.

Note

Repeat play is canceled when you turn the power off.

Repeating a Specific Portion (A↔B Repeat)



DVD

VIDEO CD

CD

You can play a specific portion of a title, chapter, track repeatedly. This is useful when you want to memorize lyrics.

During PBC Playback of VIDEO CDs (page 22), this function is available only while playing moving pictures. You may not be able to do A↔B Repeat Play depending on the DVD.

Select "A-B REPEAT" after pressing DISPLAY. During A↔B Repeat Play, the indicator of the "A-B REPEAT" lights in green.

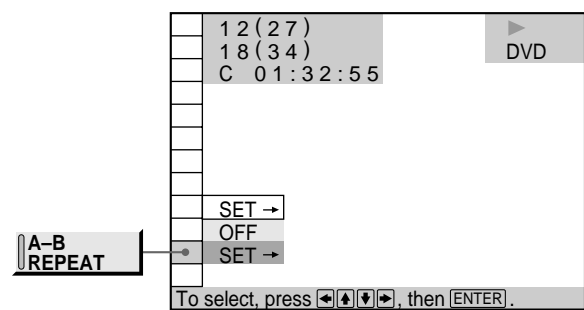

A-B REPEAT

- **SET→:** sets the A and B points.
- **OFF:** does not play a specific portion of a title/chapter/track repeatedly.

Repeating a Specific Portion (A↔B Repeat)

Setting a portion for A↔B repeat

1 Select "SET→" in "A-B REPEAT."

The A↔B REPEAT setting display appears.

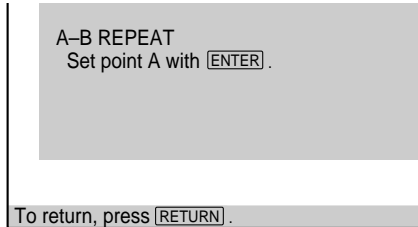
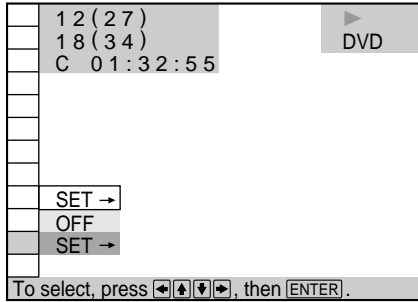

2 During playback, when you find the starting point (point A) of the portion to be played repeatedly, press ENTER.

The starting point (point A) is set.

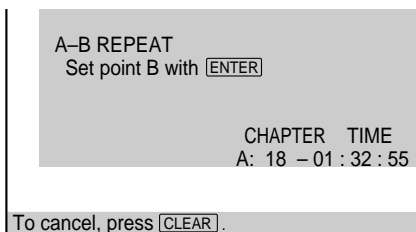

3 When you reach the ending point (point B), press ENTER again.

The setting points are displayed and the player starts repeating this specific portion.

"A-B" appears on the front panel display during A↔B repeat play.

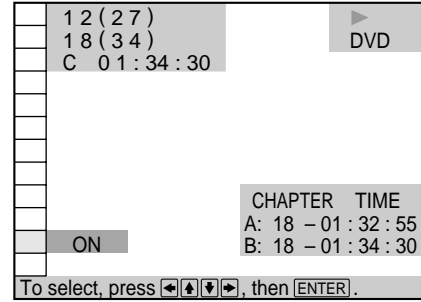

To cancel A↔B Repeat Play

Press CLEAR.

Notes

- You can set A↔B Repeat on only one specific portion.
- A↔B Repeat is canceled when:
 - you open or close the disc tray
 - you turn the power off
- When you set A↔B Repeat, the settings for Shuffle Play and Program Play are canceled.
- You may not be able to set A↔B Repeat, depending on the scene of the DVD or the VIDEO CD.

Checking the Play Information

You can check the play information on the bit rate, bit rate history or the portion where the disc is played (layer). While playing a disc, the approximate bit rate of the playback picture is always displayed by Mbps (Mega bit per second) and the audio by Kbps (Kilo bit per second). Select "ADVANCED" after pressing DISPLAY.

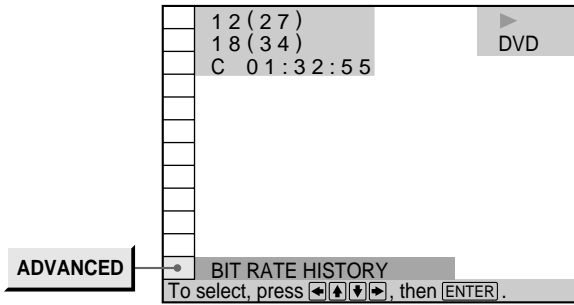

■ ADVANCED

When playing a DVD

- **BIT RATE:** displays bit rate.
- **BIT RATE HISTORY:** displays bit rate and bit rate history.
- **LAYER:** displays layer and the point picked up.
- **OFF:** turns off ADVANCED display.

Displays of each item

BIT RATE

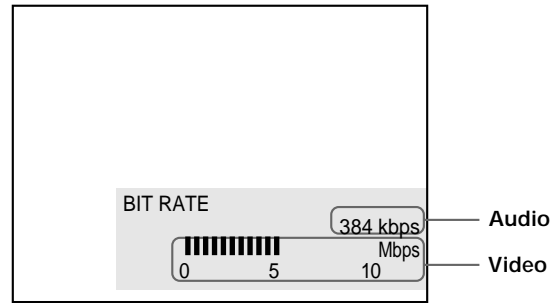

When you play MPEG AUDIO sound tracks

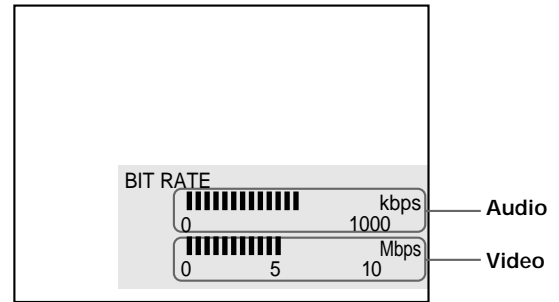

Bit rate refers to the amount of video/audio data per second in a disc. The higher the bit rate is, the larger the amount of data. When the bit rate level is high, there is a large amount of data. However, this does not always mean that you can get higher quality pictures or sounds.

BIT RATE HISTORY

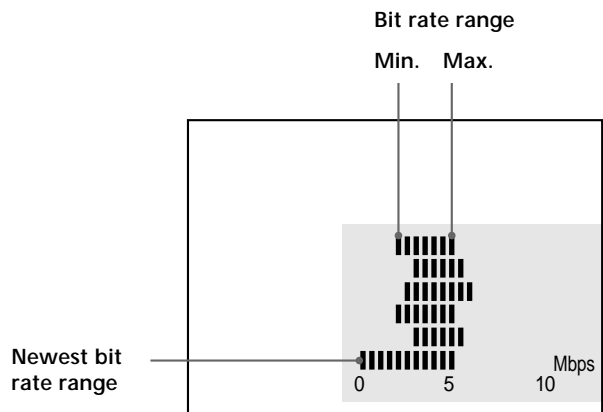

Indicates the transition of bit rate of the playback picture for a period up to the present.

Checking the Play Information

LAYER

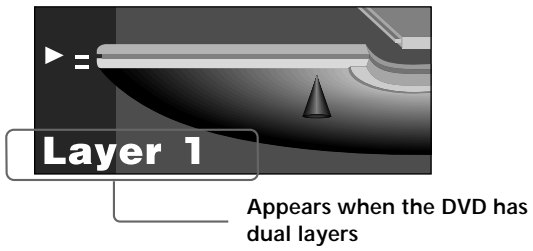

Indicates the approximate point where the disc is playing. If it is a dual-layer DVD, the player indicates which layer is being read. For details on the layers, see page 70.

Reducing the Picture Noise (DNR: Digital Video Noise Reduction)

You can make the picture clearer by reducing the picture noise of the background.

Select "DNR" after pressing DISPLAY.

When you select "DNR1," "DNR2," or "DNR3," the indicator of the "DNR" lights in green.

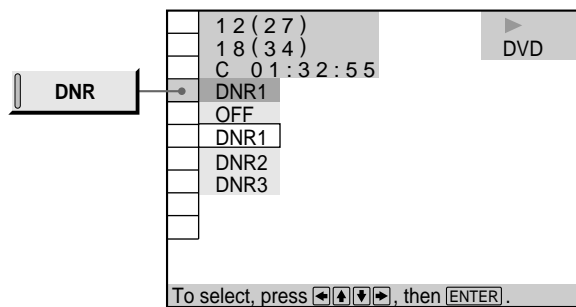

■ DNR

As the value increases, the picture noise will be reduced. However, afterimages may increase.

- **OFF**: turns off the DNR function
- **DNR1**
- **DNR2**
- **DNR3**

Notes

- Depending on the disc, the effect may be difficult to tell.
- If the afterimages appear on the TV screen, set the noise reduction function to off on your TV. Then set "DNR" to "OFF" on the Control Menu display.

Adjustments for Playback Picture (VIDEO EQ: Video Equalizer)

You can adjust the video output of the DVD or VIDEO CD from the player, not from the TV, to obtain the picture quality you want. Choose one of the video modes whichever best suits the program you are watching. When you select "MEMORY→" in a menu item, adjust the value.

Select "VIDEO EQ" after pressing DISPLAY.

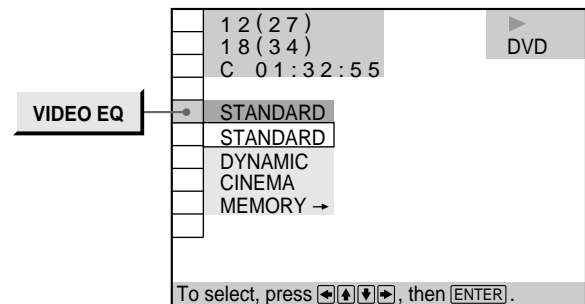

■ VIDEO EQ

Selects the setting of video control.

- **STANDARD**: displays a standard picture
- **DYNAMIC**: emphasizes the black level and so produces a bolder dynamic picture
- **CINEMA**: displays the picture with soft focus
- **MEMORY→**: adjusts the picture items

To adjust the picture items

You can adjust the following picture items individually.

- **PICTURE**
- **BRIGHTNESS**
- **COLOR**
- **SHARPNESS**

Adjustments for Playback Picture (VIDEO EQ: Video Equalizer)

- 1 Select "MEMORY➡" in "VIDEO EQ."
The video control display appears.

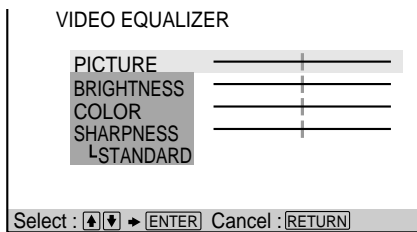
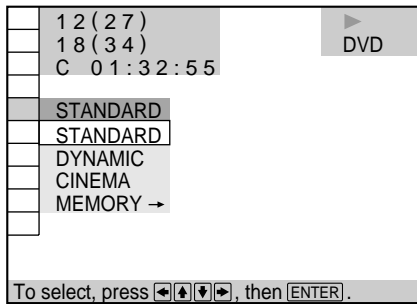

- 2 Select the picture item you want to adjust using **↑/↓**, then press **ENTER**.
The adjustment bar of the selected item appears.
To cancel adjusting the picture halfway, press **↶/↷**RETURN.

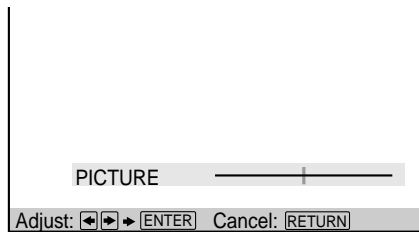

- 3 Adjust the selected picture item using **←/→**, then press **ENTER**.
The setting is stored in memory.

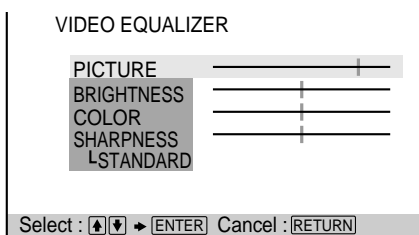

- 4 To adjust other items, repeat Steps 2 and 3.

To exit the video control display

Press **↶/↷**RETURN.



To reset the picture items
Select "STANDARD" in "MEMORY➡."

Note

Only one setting of the picture items you adjusted in "MEMORY➡" can be stored. When you adjust the items, new setting erases the setting adjusted before.

Displaying Different Angles Simultaneously

With DVDs on which various angles (multi-angles) for a scene are recorded, you can display all the angles recorded on the disc on the same screen, and start playback in continuous mode at the chosen angle directly. The angles are displayed on a screen divided in 9 sections. Select "ANGLE VIEWER" after pressing DISPLAY. When you can select "ANGLE VIEWER", the indicator of the "ANGLE VIEWER" lights in green.

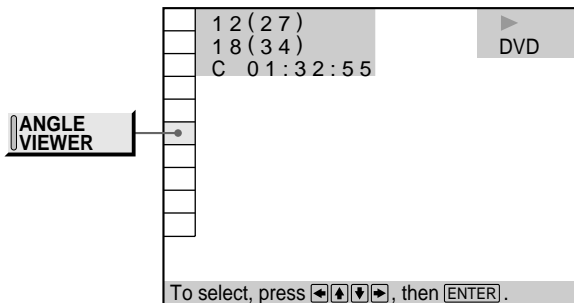

To select the one angle

Select the angle using **←/↑/↓/→**, then press **ENTER**. The selected angle only is displayed.

To cancel displaying multi-angles

Press **↶RETURN**.

 You can check the number on the front panel display. The number of the angle you select is displayed on the front panel display.

Notes

- Depending on the DVD, you may not be able to change the angles even if multi-angles are recorded on the DVD.
- When a scene for which various angles (multi-angles) are not recorded comes while displaying different angles simultaneously, the player returns to the normal play.

Dividing a Track into 9 Sections (Strobe Play)

You can display 9 consecutive sections of the disc on the screen. In this case, the sections show still images. Select "STROBE PLAYBACK" after pressing DISPLAY.

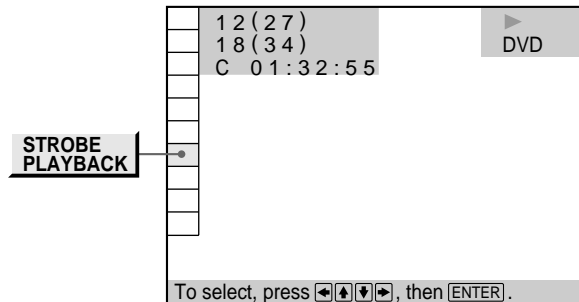

To cancel watching the strobe play

Press **↶RETURN**.

 During pause mode, 9 still images around the pause position are displayed. It is convenient to see the still images around the specific portion.

Note

Depending on the disc, there are some scenes you may not be able to watch with the strobe play.

Scanning the Title, Chapter and Track



You can check the top picture of titles, chapters and tracks of the disc on a screen divided in 9 sections, and start playback from the chosen title, chapter or track. Select "TITLE VIEWER" (DVD only), "CHAPTER VIEWER" (DVD only) or "TRACK VIEWER" (VIDEO CD only) after pressing DISPLAY.

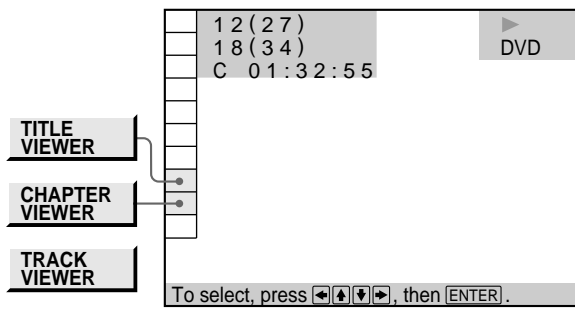

To start playback from the selected picture

Select the picture using $\leftarrow/\uparrow/\downarrow/\rightarrow$, then press ENTER. The playback starts from the selected picture.

When there are over 9 titles or chapters \blacktriangledown appears at the right bottom of the screen. Select the right bottom scene (the position of 9) and use \downarrow to display next titles, tracks or chapters. To return to the previous scene, select the left top scene (the position of 1) and press \uparrow .

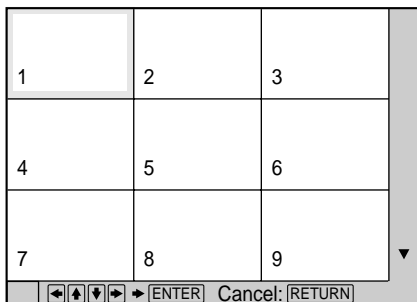

You can check the number on the front panel display. The number of the title, chapter and track you select is displayed on the front panel display.

To cancel scanning the title, chapter and track

Press \hookrightarrow RETURN.

Notes

- Depending on the disc, you may not be able to scan the title, chapter and track.
- You cannot scan the track on a VIDEO CD during PBC playback.

Setting and Selecting Favorite Scene (Bookmark)



You can have the player store specific portions of the disc in memory and play them immediately whenever you want without the need to search (Bookmark). Up to 9 bookmarks per disc for up to 200 discs can be stored in memory.

Select "BOOKMARK" after pressing DISPLAY. When you play the disc which has bookmarks, the indicator of the "BOOKMARK" lights in green.

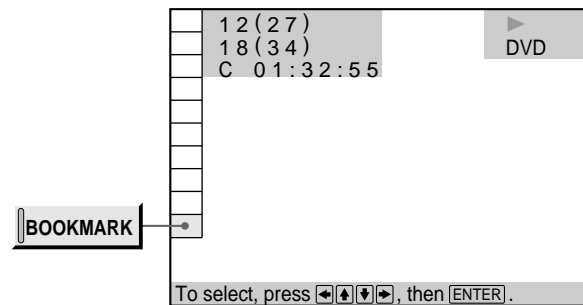

To start playback from the selected picture

Select the picture using $\leftarrow/\uparrow/\downarrow/\rightarrow$, then press ENTER. The playback starts from the selected picture.

To cancel scanning the bookmark pictures

Press \hookrightarrow RETURN.

To reset the bookmark

Select the the point on which you want to reset the bookmark using $\leftarrow/\uparrow/\downarrow/\rightarrow$, then press CLEAR.

To reset the all bookmarks of the player

Select "BOOKMARK RESET \rightarrow " under the "CUSTOM SETUP" in the setup display. For details on resetting all the bookmark of the player, see page 55.

Setting the bookmark

During playback, when you find the scene to be bookmarked, press BOOK MARK on the remote. The bookmark is set.

Notes

- The player can store in memory the bookmarks of up to 200 discs. When you have the player store over 200 discs in memory, each new bookmark erases the bookmark from those first stored.
- You may not set the bookmark depending on the discs.

Settings and Adjustments

This chapter describes how to set and how to adjust using the on-screen SET UP menu. Most settings and adjustments are required to be set when you first use the player. This chapter also describes how to set the remote for controlling the TV or the AV receiver (amplifier).

Using the Setup Display



Using the setup display, you can do the initial setup, adjusting the picture and sound quality, setting the various outputs, etc. You can also set a language for the subtitles and the setup display, limit playback by children, etc.

For details on each setup display item, see pages 52 to 64.

Note

You can display the setup display only when the player is in stop mode.

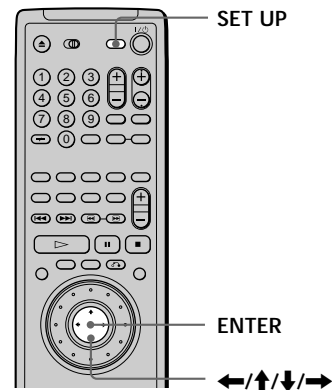

- 1 Press SET UP to display the setup display on the TV screen.

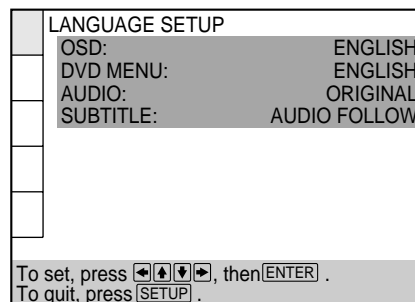

Using the Setup Display

- 2** Select the main item you want using **↑/↓**, and then press **ENTER**.

The selected main item is highlighted.

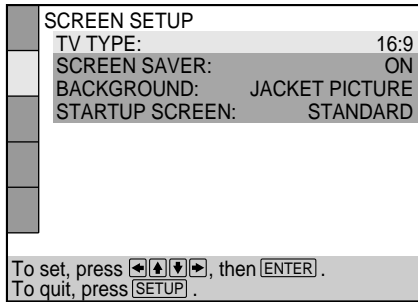
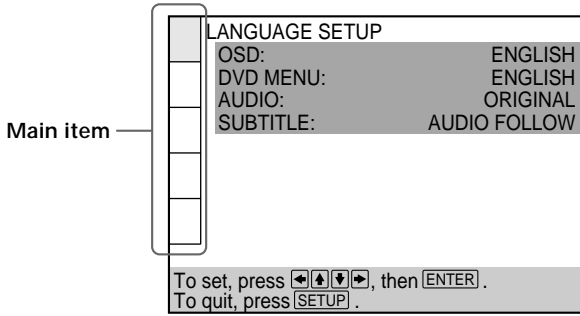

- 4** Select the setting you want using **←/↑/↓/→**, then press **ENTER**.

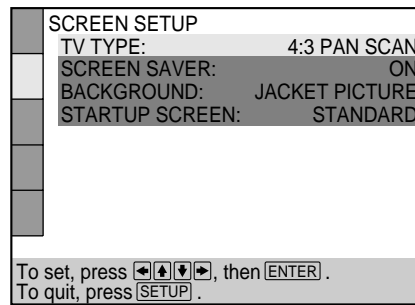
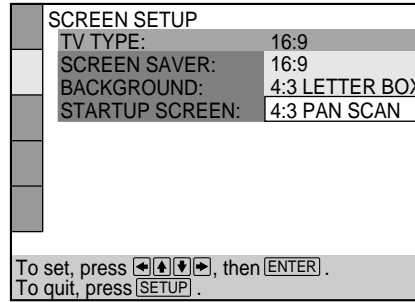

- 3** Select the item you want using **↑/↓**, then press **→** or **ENTER**.

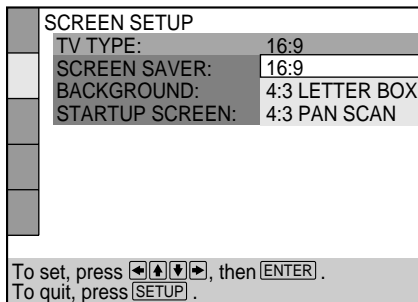
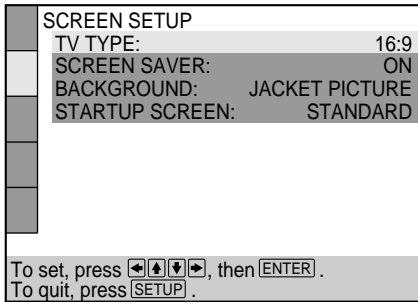

To cancel using the setup display on the way

Press **SET UP** on the remote.

Note

Some setup display items require operations other than selecting the setting. For details on these items, see the relevant pages.

Setup Display Item List

Default settings are underlined.

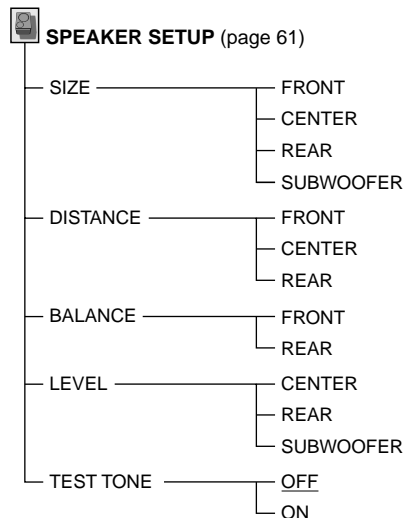
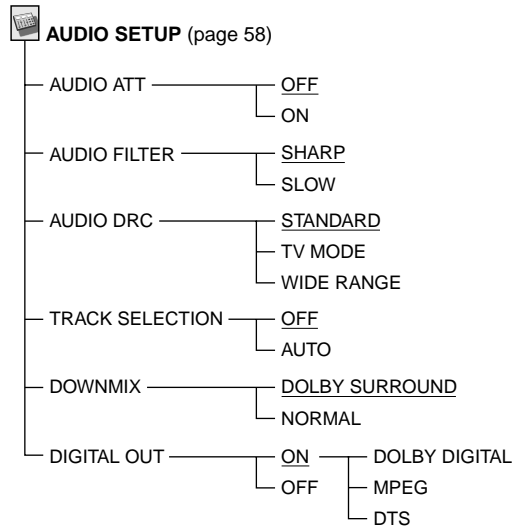
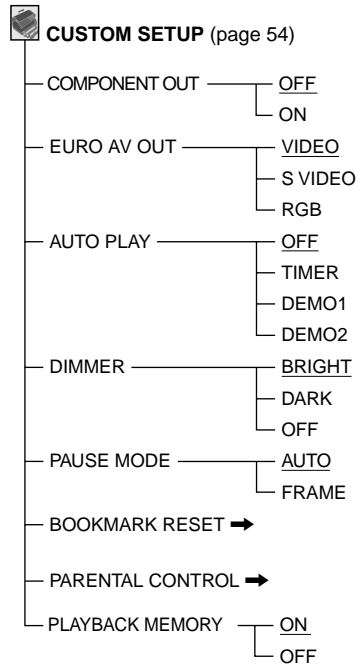
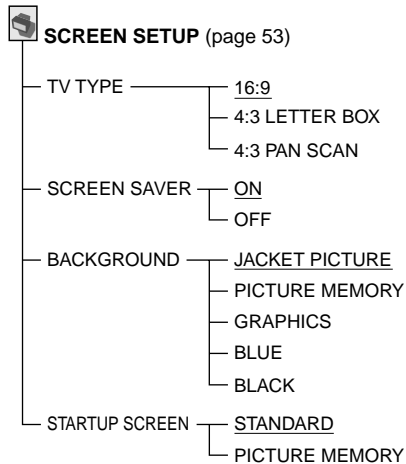

Setting the Language for Display and Sound (LANGUAGE SETUP)



Select "LANGUAGE SETUP" after pressing SET UP.
"LANGUAGE SETUP" allows you to set various languages for on-screen display or sound.
Default settings are underlined.

Note

When you select a language that is not recorded on the DVD, one of the recorded languages is automatically selected except for the "OSD".

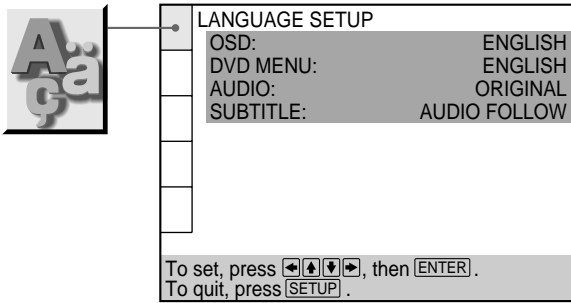

■ OSD (On-Screen Display)

Switches the language for the on-screen display.

- РУССКИЙ (RUSSIAN)
- ENGLISH (ENGLISH)

■ DVD MENU

Switches the language for the DVD menu.

- РУССКИЙ (RUSSIAN)
- ENGLISH (ENGLISH)
- FRANÇAIS (FRENCH)
- DEUTSCH (GERMAN)
- ITALIANO (ITALIAN)
- ESPAÑOL (SPANISH)
- NEDERLANDS (DUTCH)
- DANSK (DANISH)
- SVENSKA (SWEDISH)
- SUOMI (FINNISH)
- NORSK (NORWEGIAN)
- PORTUGUÊS (PORTUGUESE)
- CHINESE (CHINESE)
- JAPANESE (JAPANESE)
- OTHERS➡

When you select "OTHERS➡," select and enter the language code from the list using the number buttons (page 72).
After you have once selected, the language code (4 digits) is displayed.

■ AUDIO

Switches the language for the sounds.

- ORIGINAL: the language given priority in the disc
- РУССКИЙ (RUSSIAN)
- ENGLISH (ENGLISH)
- FRANÇAIS (FRENCH)
- DEUTSCH (GERMAN)
- ITALIANO (ITALIAN)
- ESPAÑOL (SPANISH)
- NEDERLANDS (DUTCH)
- DANSK (DANISH)
- SVENSKA (SWEDISH)
- SUOMI (FINNISH)
- NORSK (NORWEGIAN)
- PORTUGUÊS (PORTUGUESE)
- CHINESE (CHINESE)
- JAPANESE (JAPANESE)
- OTHERS➡

When you select "OTHERS➡," select and enter the language code from the list using the number buttons (page 72).

After you have once selected, the language code (4 digits) is displayed.

■ SUBTITLE

Switches the language for the subtitles.

- AUDIO FOLLOW*
- РУССКИЙ (RUSSIAN)
- ENGLISH (ENGLISH)
- FRANÇAIS (FRENCH)
- DEUTSCH (GERMAN)
- ITALIANO (ITALIAN)
- ESPAÑOL (SPANISH)
- NEDERLANDS (DUTCH)
- DANSK (DANISH)
- SVENSKA (SWEDISH)
- SUOMI (FINNISH)
- NORSK (NORWEGIAN)
- PORTUGUÊS (PORTUGUESE)
- CHINESE (CHINESE)
- JAPANESE (JAPANESE)
- OTHERS➡

When you select "OTHERS➡," select and enter the language code from the list using the number buttons (page 72).

After you have once selected, the language code (4 digits) is displayed.

* When you select "AUDIO FOLLOW," the language for the subtitles changes according to the language for the setting you selected in "AUDIO."

Note

The player gives priority to the settings of "SUBTITLE" and "AUDIO" in the Control Menu display when "PLAYBACK MEMORY" is set to "ON." The settings of "SUBTITLE" and "AUDIO" selected in the setup display may not appear in this case. For details on the Playback Memory function, see page 55.

Settings for Display (SCREEN SETUP)



Select "SCREEN SETUP" after pressing SET UP.
"SCREEN SETUP" allows you to set the display according to the playback conditions.
Default settings are underlined.

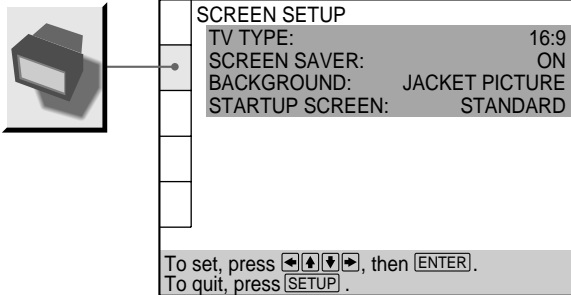

■TV TYPE

Selects the aspect ratio of the TV to be connected.

- 16:9: when you connect a wide-screen TV to the player.
- 4:3 LETTER BOX: when you connect a normal TV to the player. Displays a wide picture with bands displayed on the upper and lower portions of the screen.
- 4:3 PAN SCAN: when you connect a normal TV to the player. Displays the wide picture on the whole screen with a portion automatically cut off.

16:9

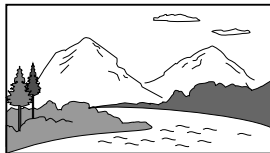

4:3 LETTER BOX



4:3 PAN SCAN

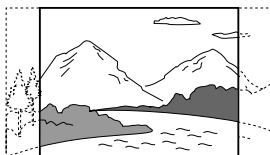

Note

Depending on the DVD, "4:3 LETTER BOX" may be selected automatically instead of "4:3 PAN SCAN" and vice versa.

■SCREEN SAVER

Turns on and off the screen saver. If you turn on the screen saver, the screen saver image appears when you leave the player or the remote in pause or stop mode for 15 minutes or when you play back a CD for more than 15 minutes. The screen saver is useful to prevent your display from becoming damaged.

- ON: turns on the screen saver.
- OFF: turns off the screen saver.

■BACKGROUND

Selects the background color or picture of the TV screen in stop mode or while playing a CD.

- JACKET PICTURE: The jacket picture appears in the background, but only when the jacket picture is already recorded on the disc.
- PICTURE MEMORY: Your favorite picture appears in the background when you have the player store in memory your favorite scene recorded on the disc for the background picture. For the way of storing in memory, see "Storing the picture in memory."
- GRAPHICS: The graphic picture stored in memory in the player beforehand appears in the background.
- BLUE: The background color is blue.
- BLACK: The background color is black.

Note

If a disc which does not contain the jacket picture is played while "BACKGROUND" is set to "JACKET PICTURE," the graphic picture stored in the player will automatically appear in the background.

■STARTUP SCREEN

Selects the startup screen. The startup screen image you selected appears when you turn on the player.

- STANDARD: The standard startup screen memorized in the player beforehand appears.
- PICTURE MEMORY: Your favorite picture appears in the startup screen when you have the player store in memory your favorite scene recorded on the disc for the startup screen. For the way of storing in memory, see "Storing the picture in memory" (page 54).

Settings for Display (SCREEN SETUP)

Storing the picture in memory

During playback, when you find the scene to be stored in memory, press PICTURE MEMORY on the remote.

The picture is stored in memory.

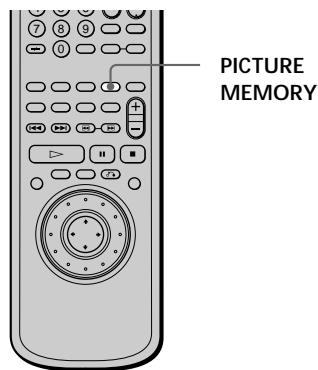

Notes

- The player can store in memory only one scene. The stored picture appears in both the background and the startup screen.
- When the picture is stored in memory by pressing PICTURE MEMORY, the picture stored before is not retained in memory.
- When you operate this player during storing picture in memory, the picture does not be stored in memory.

Custom Settings (CUSTOM SETUP)

Select "CUSTOM SETUP" after pressing SET UP. "CUSTOM SETUP" allows you to set the playback conditions.

Default settings are underlined.

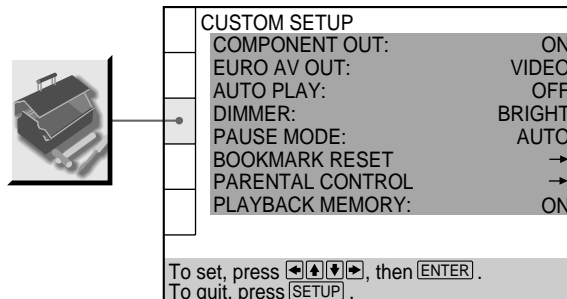

■COMPONENT OUT

Selects the methods of outputting video signals from the COMPONENT VIDEO OUT (Y, C_B/B-Y, C_R/R-Y) connectors on the rear panel of the player.

When you select "ON," you need to connect the monitor or projector via EURO AV, VIDEO OUT or S VIDEO OUT beforehand.

- OFF: outputs no signals.
- ON: outputs the component video signals.

Notes

- When you set "EURO AV OUT" to "RGB", you cannot set "COMPONENT OUT" to "ON."
- When you connect the player to a monitor or projector via only the COMPONENT VIDEO OUT connectors, do not select "OFF." If you select "OFF" in this case, the picture may not appear.

■EURO AV OUT

Selects the methods of outputting video signals from the EURO AV 1(RGB)-TV connectors on the rear panel of the player.

- VIDEO: outputs the video signals.
- S VIDEO: outputs the S video signals.
- RGB: outputs the RGB signals.

Notes

- When you set "COMPONENT OUT" to "ON", you cannot set "EURO AV OUT" to "RGB."
- If your TV is not conformed to the S video or the RGB signals, no picture appears on the TV screen even if you select "S VIDEO" or "RGB." Refer to the instructions supplied with your TV.
- If your TV has only one EURO AV IN connector, do not select "S VIDEO."

■AUTO PLAY

Selects the setting of Auto Play when you connect the AC power cord to the AC outlet.

- OFF: does not use "TIMER," "DEMO1" or "DEMO2" to start playing.

- **TIMER:** starts playing a disc automatically when you connect the AC power cord to the AC outlet. By connecting a timer (not supplied), you can start playing at any time you want.
- **DEMO1:** starts playing the demonstration 1 automatically.
- **DEMO2:** starts playing the demonstration 2 automatically.

■ DIMMER

Adjusts the lighting of the front panel display.

- **BRIGHT:** makes the front panel display bright.
- **DARK:** makes the front panel display dark.
- **OFF:** turns off the lighting of the front panel display.

■ PAUSE MODE (DVD only)

Selects the picture in pause mode.

- **AUTO:** A picture including subjects that move dynamically is output with no jitter. Normally select this position.
- **FRAME:** A picture including subjects that do not move dynamically is output with high resolution.

■ BOOKMARK RESET →

Select "BOOKMARK RESET." The BOOKMARK reset display appears. And then press ENTER to reset all bookmarks.

■ PARENTAL CONTROL →

Sets a password and playback limitation level when you play DVDs with playback limitation for children. For details, see "Limiting Playback by Children (Parental Control) ."

■ PLAYBACK MEMORY

You can have the player store the settings of SUBTITLE and VIDEO EQ, etc., of each disc up to 200 discs. (Playback Memory)

Set the Playback Memory function on or off.

- **ON:** stores the settings in memory when you eject the disc.
- **OFF:** does not store the settings in memory.

Following settings are stored in memory with the Playback Memory function.

- AUDIO (page 33)
- SUBTITLE (page 34)
- ANGLE (page 35)
- VIRTUAL 3D SURROUND (page 36)
- VIDEO EQ (page 45)
- DNR (page 45)

Note

The player can store in memory the settings of up to 200 discs. When you have the player store over 200 discs in memory, each new setting erases the setting from those first stored.

Limiting Playback by Children (Parental Control) **DVD**

Select "CUSTOM SETUP" after pressing SET UP.

Playing some DVDs can be limited depending on the age of users. The "Parental Control" function allows you to set a playback limitation level.

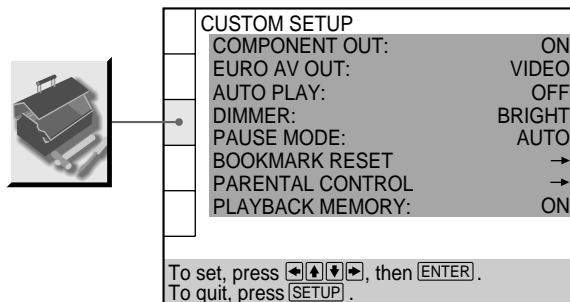

- 1 Select "PARENTAL CONTROL" using ↑/↓, then press ENTER.

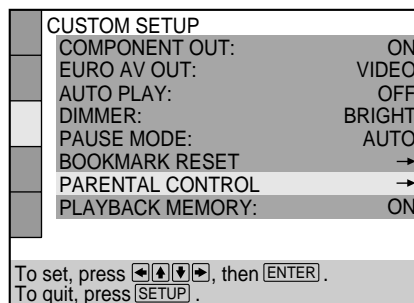

- When you have not entered a password yet
The display for entering a password appears.

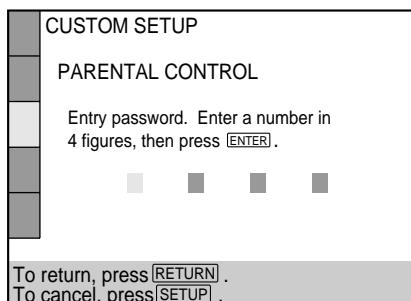

- When you have already entered a password
The display for confirming the password appears. Skip Step 2.

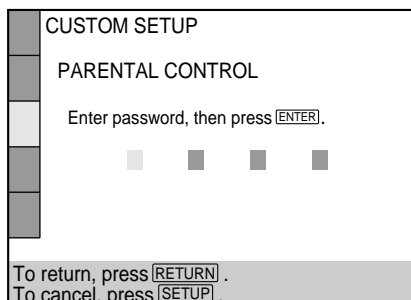

Custom Settings (CUSTOM SETUP)

- 2** Enter a password in 4 digits using the number buttons, then press ENTER.
The digits change to asterisks (*), and the display for confirming the password appears.

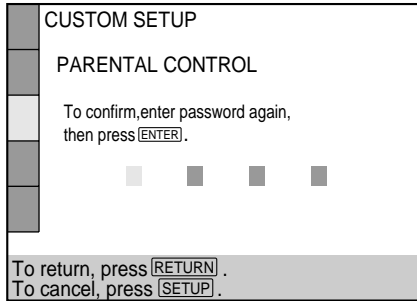

- 3** To confirm your password, enter it using the number buttons, then press ENTER.
The display for setting the playback limitation level and changing the password appears.

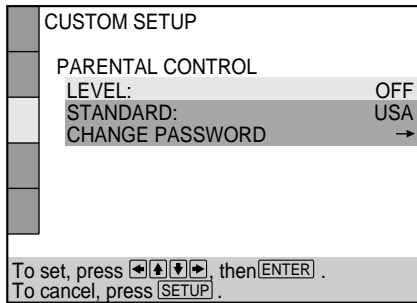

- 4** Select "STANDARD" using ↑/↓, then press →.

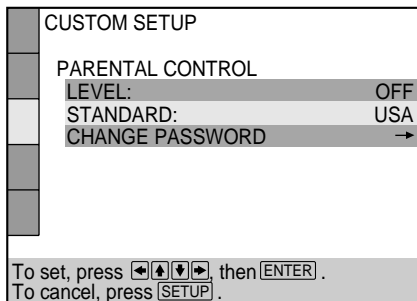

- 5** Select an area as the standard for playback limitation level using ↑/↓, then press →.
When you select "OTHERS→," select and enter the standard code in the table below using number buttons.

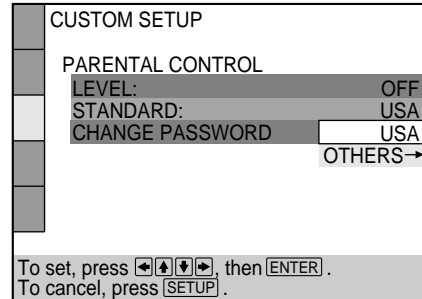

- 6** Select "LEVEL" using ↑/↓, then press →.

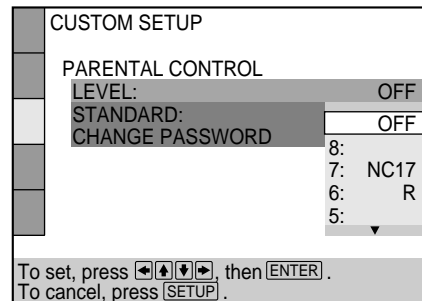

- 7** Select the level you want using ↑/↓, then press ENTER.

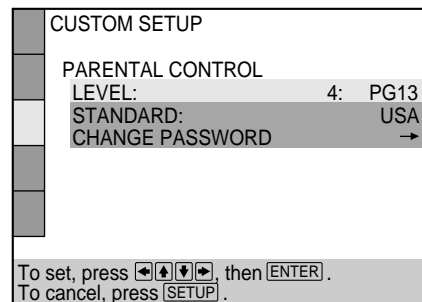

The lower the value is, the more strict the limitation.

To return to the normal screen

Press SET UP.

To turn off the Parental Control function and play the DVD after entering your password

Set "LEVEL" to "OFF" in Step 7, then press ▷.

To change the password

- 1** After Step 3, select "CHANGE PASSWORD" using ↑/↓, then press → or ENTER.

The display for changing the password appears.

- 2** Follow Steps 2 and 3 to enter a new password.

 You can turn off the Parental Control function just after inserting the DVD (Parental Control Temporarily Canceled). When you set a playback limitation level and insert the DVD, the PARENTAL CONTROL display appears. Enter the password to turn off the Parental Control function. When you stop playing the DVD, the level returns to the original level.

 **If you have forgot your password**

Enter the 6 digits number “199703” in Step 2 to clear the current password. To enter a new password, follow the procedure from Step 2 again.

Notes

- When you play DVDs which do not have the Parental Control function, playback cannot be limited on this player.
- When you do not set a password, you cannot change the settings for playback limitation.
- Depending on the DVD, you may be asked to change the parental control level while playing the disc. In this case, enter the password, then change the level. When you stop playing the DVD, the level returns to the original level.

Standard	Code number
Austria	2046
Belgium	2057
Canada	2079
China	2092
Denmark	2115
Finland	2165
France	2174
Germany	2109
Hong Kong	2219
Indonesia	2238
Italy	2254
Japan	2276
Malaysia	2363
Netherlands	2376
Norway	2379
Philippines	2424
Russian	2489
Singapore	2501
Spain	2149
Sweden	2499
Switzerland	2086
Taiwan	2543
Thailand	2528
United Kingdom	2184

Settings for Sound (AUDIO SETUP)

Select "AUDIO SETUP" after pressing SET UP.

"AUDIO SETUP" allows you to set the sound according to the playback conditions.

Default settings are underlined>.

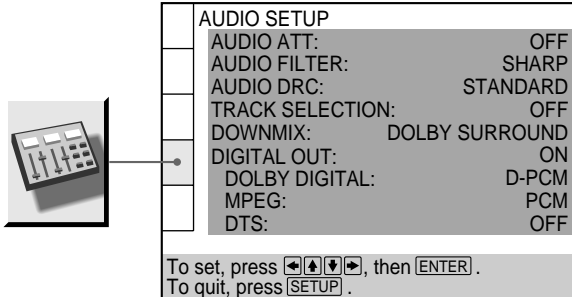

■AUDIO ATT (attenuation)

Selects the setting of the output from the AUDIO OUT, EURO AV (1,2) and 5.1 OUTPUT connectors according to the audio equipment to be connected.

- OFF: turns off the audio attenuation.
- ON: reduces the audio output level so that no sound distortion occurs.

Note

The setting does not affect the output from the DIGITAL OUT OPTICAL and COAXIAL connectors.

■AUDIO FILTER

Selects the type of digital filter to reduce the noise of a frequency higher than 22.05kHz (fs 44.1kHz), 24kHz (fs 48kHz) or 48kHz (fs 96kHz).

- SHARP: makes the sound clear and provides smooth sound reproduction. Normally set this position.
- SLOW: makes the sound warm and deep.

Note

Depending on the disc, the effect on the sound may be difficult to hear.

■AUDIO DRC (Dynamic Range Control)

Makes the sound clear with the volume turned down at night, etc., when you play a DVD. This affects the output from the DIGITAL OUT connectors only when "PCM" in "DIGITAL OUT" is set to "ON," and it affects the output from the AUDIO OUT, EURO AV (1,2) and 5.1CH OUTPUT connectors.

- STANDARD: Normally select this position.
- TV MODE: makes the low sound clear even if you turned the volume down, so it is good for playing at night. It is especially recommended when you listen to the sound using the speakers of the TV.
- WIDE RANGE: It gives you the feeling of being at a live performance. When you use high quality speakers, it is more effective.

Notes

- When you play DVDs without the AUDIO DRC function, there may be no effect on the sound.
- When this item is set to "WIDE RANGE," the sound volume from other than the 5.1CH OUTPUT connectors may be less than usual.
- "WIDE RANGE" cannot be selected when you have selected "NONE" in "SIZE" under "SPEAKER SETUP."

■TRACK SELECTION

Gives the sound track which contains the highest number of the channels priority when you play a DVD on which multiple audio formats are recorded. If multiple audio channels are recorded in PCM, DTS, MPEG AUDIO or Dolby Digital format, the higher-numbered channel audio recorded in PCM, DTS, MPEG AUDIO or Dolby Digital format is played.

- OFF: No priority given.
- AUTO: Priority given.

Notes

- When the player stores the settings in memory with the Playback Memory function, the player may not give priority even if you select "AUTO."
- When you set this item to "AUTO", the language may change depending on the "AUDIO" settings in "LANGUAGE SETUP." The "TRACK SELECTION" setting has higher priority than that of "AUDIO" settings in "LANGUAGE SETUP" (page 52).
- If you set "DTS" in "AUDIO SETUP" to "OFF", the DTS sound track is not played even if you set this item to "AUTO" and the highest-numbered channel audio is recorded in DTS format.
- If PCM, DTS, MPEG AUDIO and Dolby Digital sound tracks have the same number of the highest channels, the player selects PCM, DTS, Dolby Digital and MPEG AUDIO sound tracks, in this order.
- Depending on the DVD, the audio with priority may be predetermined. In this case, you cannot give priority to the DTS, MPEG AUDIO or Dolby Digital format by selecting "AUTO."

■DOWNMIX*

Switches the mixing down methods when you play a DVD on which the sound in Dolby Digital format is recorded.

- **DOLBY SURROUND**: when the player is connected to an audio component that conforms to Dolby Surround (Pro Logic).
- **NORMAL**: when the player is connected to a normal audio component.

* The setting affects the following connectors:

- AUDIO OUT connector
- DIGITAL OUT (OPTICAL, COAXIAL) connectors.

■DIGITAL OUT

Selects output signals via the DIGITAL OUT OPTICAL and COAXIAL connectors.

- **ON**: Normally select this position. When you select "ON," set "DOLBY DIGITAL," "MPEG" and "DTS." For details on setting them, see "Setting for the Signal to the Digital Output."
- **OFF**: when the player does not output the sound signals via DIGITAL OUT OPTICAL and COAXIAL connectors, if you select this position, the influence of the digital circuit upon the analog one is minimum.





Notes

- When you play the sound tracks with 96 kHz sampling frequency, the output signals from the DIGITAL OUT (OPTICAL, COAXIAL) are converted to 48 kHz (sampling frequency). When the signals are output from AUDIO OUT connector, sampling frequency stays at 96kHz and the output signals are converted to analog signals.
- When you select "OFF," you cannot set "DOLBY DIGITAL," "MPEG" and DTS."

Setting for the Signal to the Digital Output

When you select "ON," set "DOLBY DIGITAL," "MPEG" and DTS."

Switches the methods of outputting audio signals when you connect a digital component such as a receiver (amplifier) having a digital connector, an audio component having a built-in DTS decoder, a DAT or MD via the DIGITAL OUT OPTICAL or COAXIAL connector using an optical or coaxial digital connecting cord. For details on the connection, see page 13.

AUDIO SETUP	
AUDIO ATT:	OFF
AUDIO FILTER:	SHARP
AUDIO DRC:	STANDARD
TRACK SELECTION:	OFF
DOWNMIX:	DOLBY SURROUND
DIGITAL OUT:	ON
DOLBY DIGITAL:	D-PCM
MPEG:	PCM
DTS:	OFF
To set, press     , then [ENTER].	
To quit, press [SETUP].	

■DOLBY DIGITAL

Selects output Dolby Digital signals via the DIGITAL OUT OPTICAL and COAXIAL connectors. You cannot select this item when you set "DIGITAL OUT" to "OFF."

- **D-PCM** (Downmix PCM): when you play the Dolby Digital sound tracks, the output audio signals are mixed down to 2 channels. With the settings of the item "DOWNMIX" in "AUDIO SETUP," you can select whether the signals conform to Dolby Surround (Pro Logic) or not.
- **DOLBY DIGITAL**: when the player is connected to an audio component with a built-in Dolby Digital decoder.

Note

If the player is connected to an audio component lacking a built-in Dolby Digital decoder, do not set "DOLBY DIGITAL" in "AUDIO SETUP" to "DOLBY DIGITAL." Otherwise, when you play the Dolby Digital sound track, a loud noise or no sound will come out from the speakers, affecting your ears or causing the speakers to be damaged.

Settings for Sound (AUDIO SETUP)

■ MPEG

Selects output MPEG AUDIO signals via the DIGITAL OUT OPTICAL and COAXIAL connectors. You cannot select this item when you set "DIGITAL OUT" to "OFF."

- **PCM:** when the player is connected to an audio component lacking a built-in MPEG decoder. If you play MPEG AUDIO sound tracks, the player outputs stereo signals taken from MPEG AUDIO signals via the DIGITAL OUT OPTICAL and COAXIAL connectors.
- **MPEG:** when the player is connected to an audio component having a built-in MPEG decoder.

Note

If the player is connected to an audio component lacking a built-in MPEG decoder, do not set "MPEG" in "AUDIO SETUP" to "MPEG." Otherwise, when you play the MPEG AUDIO sound track, a loud noise will come out from the speakers, affecting your ears or causing the speakers to be damaged.

Note

The player outputs the MPEG analog audio sound only from the front speakers when you set "DIGITAL OUT" in "AUDIO SETUP" to "ON" and then set "MPEG" to "MPEG."

■ DTS

Selects output DTS signals via the DIGITAL OUT OPTICAL and COAXIAL connectors. You cannot select this item when you set "DIGITAL OUT" to "OFF."

- **OFF:** when the player is connected to an audio component lacking a built-in DTS decoder.
- **ON:** when the player is connected to an audio component having a built-in DTS decoder.

Note

Select the setting correctly. Otherwise, no sound or strange sound will come out from the speakers, affecting your ears or causing the speakers to be damaged.

- **Do not play the DTS sound tracks without connecting the player to an audio component having a built-in DTS decoder. You cannot hear the DTS sound unless you connect the player to an audio component having a built-in DTS decoder.**
- **When you play the DTS sound track on a CD, a loud noise may come out from the AUDIO OUT, 5.1CH OUTPUT and PHONES connectors, affecting your ears or causing the speakers or headphones to be damaged.**
- **When you play the DTS sound track on a DVD, no sounds will come out from the AUDIO OUT, 5.1CH OUTPUT and PHONES connectors.**

Notes on playing the DTS sound tracks on a CD

- Do not play the DTS sound tracks without connecting the player to an audio component having a built-in DTS decoder. The player output the DTS signal via the DIGITAL OUT OPTICAL and COAXIAL connectors even if "DTS" in "AUDIO SETUP" is set to "OFF" in the setup display, affecting your ears or causing the speakers to be damaged.
- The DTS indicator on the front panel does not light up even if the player outputs DTS signal via the DIGITAL OUT OPTICAL and COAXIAL connectors.
- Set the sounds to "STEREO" when you play the DTS sound tracks on a CD. (See "Changing the Sounds" on page 33.) If you set the sounds to "1/L" or "2/R", no sounds will come out from the DIGITAL OUT OPTICAL and COAXIAL connectors.

Notes on playing the DTS sound tracks on a DVD

- No sounds will come out from the AUDIO OUT and PHONES connectors.
- If the player is connected to an audio component lacking a built-in DTS decoder, do not set "DTS" in "DIGITAL OUT" to "ON" in the setup display. Otherwise, when you play the DTS sound track, a loud noise will come out from the speakers, affecting your ears or causing the speakers to be damaged.
- When you set "DTS" in "AUDIO SETUP" to "OFF", no sound will come out from the DIGITAL OUT OPTICAL and COAXIAL connectors even if you play DTS sound tracks on DVDs.

Speaker Set Up

Select "SPEAKER SETUP" after pressing SET UP.

To obtain the best possible surround sound, first specify the size of speakers you have connected and their distance from your listening position and set the balance and level. Then use the test tone to adjust the speaker volumes to the same level.

For the speaker hook ups, see pages 14 to 15.

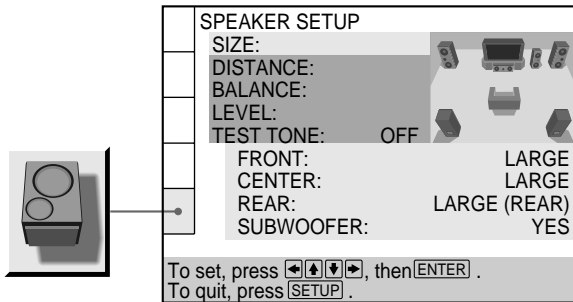

■ SIZE

Selects the size of the speakers to be connected.

- FRONT
 - LARGE**: Normally select this.
 - SMALL**: When the sound cracks or the effects of the surround is difficult to hear, select this. This activates the Dolby Digital bass redirection circuitry and outputs the bass frequencies of the speaker from subwoofers.
- CENTER
 - NONE**: If you will not connect a center speaker, select this.
 - LARGE**: Normally select this.
 - SMALL**: When the sound cracks, select this. This activates the Dolby Digital bass redirection circuitry and outputs the bass frequencies of the speaker from some other speakers .
- REAR
 - NONE**: If you will not connect a rear speaker, select this.
 - LARGE (REAR*/SIDE*)**: Normally select this.
 - SMALL (REAR*/SIDE*)**: When the sound cracks or the effects of the surround is difficult to hear, select this. This activates the Dolby Digital bass redirection circuitry and outputs the bass frequencies of the speaker from some other speakers .
- SUBWOOFER
 - NONE**: If you do not connect a subwoofer, select this. This activates the Dolby Digital bass redirection circuitry and outputs the LFE signals from the front speakers.
 - YES**: If you connect a subwoofer, select this to output the LFE (low frequency effects) channel from the subwoofer.

* Rear speaker position (REAR/SIDE)

These items let you specify the location of your rear speakers for proper implementation of "VIRTUAL REAR SHIFT" and "VIRTUAL MULTI REAR" in the Control Menu display. Refer to the illustration below.

- Set to "SIDE" if the location of your rear speakers corresponds to section A.
- Set to "REAR" if the location of your rear speakers corresponds to section B.

This setting effects only the "VIRTUAL REAR SHIFT" and "VIRTUAL MULTI REAR" mode.

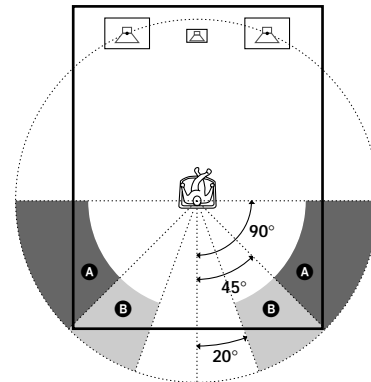

Notes

- When you select an item, the sound cuts off for a moment.
- The cut off frequency for the subwoofer is fixed at 100Hz.
- Set the subwoofer's cut off frequency as high as possible.
- Depending on the settings of other speakers, the subwoofer may output excessive sound.
- If your speakers are too small to reproduce low bass frequencies, please set all speaker settings to "SMALL" and utilize a subwoofer for low frequency sound.

■ DISTANCE

You can vary the distance of each speaker as follows. Default adjustments are in the parentheses.

- **FRONT (3.6m)**
Front speaker distance can be set in 0.2 meter steps from 1 to 15 meters.
- **CENTER (3.6m)**
Center speaker distance can be set in 0.2 meter steps from a distance 0.6 meter farther to the front speaker to a distance 1.6 meters closer to your listening position.
- **REAR (3.0m)**
Rear speaker distance can be set in 0.2 meter steps from a distance equal to the front speaker distance to a distance 5 meters closer to your listening position.

Notes

- When you set the distance, the sound cuts off for a moment.
- If each of the front or rear speakers are not placed an equal distance from your listening position, set the distance of the closest speaker.
- Do not place the rear speaker farther away from your listening position than the front speakers.

Speaker Set Up

■BALANCE

You can vary the balance of each speaker as follows. Default adjustments are in the parentheses.

- FRONT (0dB)
Adjust the balance between the front left and right speakers (-6dB [L] to +6dB [R], 0.5dB steps).
- REAR (0dB)
Adjust the balance between the rear left and right speakers (-6dB [L] to +6dB [R], 0.5dB steps).

■LEVEL

You can vary the level of each speaker as follows. Default adjustments are in the parentheses.

- CENTER (0dB)
Adjust the level of the center speaker (-6dB to +6dB, 0.5dB steps).
- REAR (0dB)
Adjust the level of the rear speakers (-6dB to +6dB, 0.5dB steps).
- SUBWOOFER (0dB)
Adjust the level of the subwoofer (-10dB to +6dB, 0.5dB steps).

■TEST TONE

You can hear the test tone from each speaker in sequence.

- OFF: The test tone is not emitted from speakers.
- ON: During adjustment of "BALANCE" or "LEVEL," the test tone is emitted from both speakers simultaneously.

Note

While you are playing a disc, you cannot hear the test tone. Execute the test tone after you stop playback.

To adjust the volume of all the speakers at one time

Use the receiver's (amplifier's) volume control.

To return to the default setting

Select the item, then press CLEAR.

Adjusting the speaker volume

- 1 While you stop playback, select "SPEAKER SETUP" after pressing SET UP.
- 2 Select "TEST TONE" and set "TEST TONE" to "ON." You will hear the test tone from each speaker in sequence.
- 3 From your listening position, select "BALANCE" or "LEVEL" and adjust the value of "BALANCE" and "LEVEL" using \uparrow/\downarrow . During this adjustment, the test tone is emitted from both speakers simultaneously.
- 4 Select "TEST TONE" and set "TEST TONE" to "OFF" to turn off the test tone.

Controlling the TV or the AV Receiver (Amplifier) with the Supplied Remote

If you adjust the remote signal, you can control your TV with the supplied remote. Default setting is to control Sony TVs with the  mark.

When you connect the player to a Sony AV receiver (amplifier), you can also set the input of the receiver (amplifier) to this player with the supplied remote.

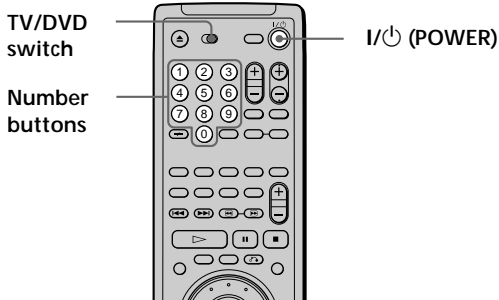

Manufacturer	Code number
Sony (default)	01
Grundig	11
Hitachi	24
Loewe	45
Nokia	15,16,69
Panasonic	17,49
Philips	06,07,08
Saba	12,13
Samsung	22,23
Sanyo	25
Sharp	29
Telefunken	36
Thomson	43
Toshiba	38

Controlling TVs with the remote

- 1 Slide TV/DVD switch to TV.
- 2 Hold down I/⏻ (POWER), and enter your TV's manufacturer's code (see the table) using the number buttons. Then release I/⏻ (POWER).

Code numbers of controllable TVs

If more than one code number is listed, try entering them one at a time until you find the one that works with your TV.

Notes

- If you enter a new code number, the code number previously entered will be erased.
- When you replace the batteries of the remote commander, the code number may reset to 01 (Sony). Reset the appropriate code number.

Controlling the TV or the AV Receiver (Amplifier) with the Supplied Remote

When you set the TV/DVD switch to TV, you can control your TV using the keys below.

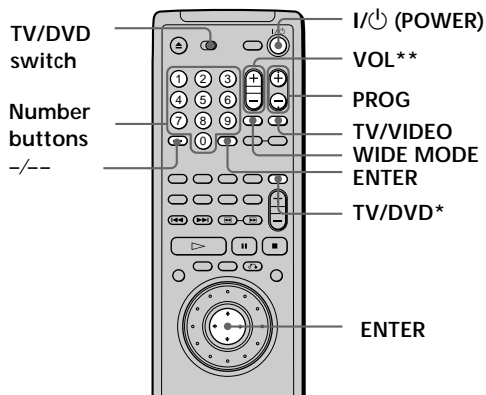

By pressing	You can
I/⏻ (POWER)	Turn the TV on or off
TV/VIDEO	Select the input source for the TV between the TV and VCR
TV/DVD*	Select the input source for the TV between the TV and CD/DVD player
VOL**	Adjust the volume of the TV
PROG	Select the program position of the TV
WIDE MODE	Switch the wide picture on or off
Number buttons and ENTER	Select the program position of the TV and ENTER

* If you connect the player to the TV via the EURO AV OUT connectors, the input source for the TV is set to the player automatically when you start playback or press any button. In this case, press TV/DVD to return the input to the TV.

** You can control the TV regardless of the position of the TV/DVD switch.

Notes

- Depending on the TV, you may not be able to control your TV or to use some of the buttons above.
- If you use number buttons to select program position of the TV, press -/-- followed by the number buttons for two-digit numbers.

Controlling an AV receiver (amplifier) with the remote

- Slide TV/DVD switch to DVD.
- Hold down I/⏻ (POWER), and enter your AV receiver's manufacturer's code (see the table below) using the number buttons. Then release I/⏻ (POWER).

Manufacturer	Code number
Sony	91 (default), 88, 89
Denon	84, 85, 86
Kenwood	92, 93
Onkyo	81, 82, 83
Pioneer	99
Sunsui	87
Technics	97, 98
Yamaha	94, 95, 96

Code numbers of controllable receivers (amplifiers)

If more than one code number is listed, try entering them one at a time until you find the one that works with your receiver.

You can also change the sound volume of the AV receiver using AV VOL.

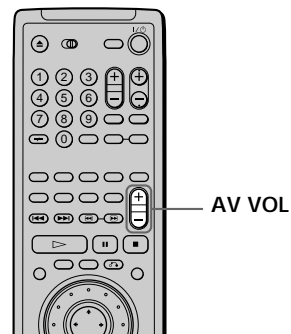

Notes

- Depending on the AV receiver (amplifier), you may not be able to control your AV receiver (amplifier).
- You can control the AV receiver (amplifier) regardless of the position of the TV/DVD switch.

Additional Information

Troubleshooting

If you experience any of the following difficulties while using the player, use this troubleshooting guide to help you remedy the problem. Should any problem persist, consult your nearest Sony dealer.

Power

The power is not turned on.

- ➔ If the indicator above the I/⏻ (POWER) button is not lit, check that the AC power cord is connected securely.

Picture

There is no picture.

- ➔ Check that the player is connected securely.
- ➔ The video connecting cord is damaged. Replace it with a new one.
- ➔ Make sure you connect the player to the video input connector on the TV. (page 8)
- ➔ Make sure you turn on the TV.
- ➔ Make sure you select the video input on the TV so that you can view the pictures from the player.
- ➔ In the setup display, set "EURO AV OUT" and "COMPONENT OUT" in "CUSTOM SETUP" to the appropriate item conforms to your system. (page 54)
- ➔ "OFF" in "COMPONENT OUT" under "CUSTOM SETUP" is selected, when you have connected the player to a monitor or projector via only the COMPONENT VIDEO OUT connectors. To view the picture, connect the monitor via EURO AV, VIDEO OUT or S VIDEO OUT.

The picture noise appears.

- ➔ Clean the disc.
- ➔ If video from your DVD player has to go through your VCR to get to your TV, the copy-protection applied to some DVD programs could affect picture quality. If you still experience problems after checking your connections, please try connecting your DVD player directly to your TV's S video-input, if your TV is equipped with this input. (page 8)
- ➔ The picture noise appears when the player is connected to the TV via the video deck. Do not connect the player to the video deck. Connect the player directly to the TV. (page 9)
- ➔ In the Control Menu display, set "VIDEO EQ" to "STANDARD." (page 45)

Troubleshooting

The aspect ratio of the screen cannot be changed even though you set "TV TYPE" in "SCREEN SETUP" in the setup display when you play a wide picture.

- ➔ The aspect ratio is fixed on your DVD.
- ➔ If you connect the player with the S video cord, connect directly to the TV. Otherwise, you may not change the aspect ratio.
- ➔ Depending on the TV, you may not change the aspect ratio.

The numbers or letters of 5 characters are displayed on the front panel display.

- ➔ Self diagnosis function was activated. See the table in page 68 and treat the player appropriately.

The picture is black and white.

- ➔ In the setup display, set "EURO AV OUT" in "CUSTOM SETUP" to the appropriate item conforms to your TV. (page 54)
- ➔ Depending on the TV, the picture on the screen becomes black and white when you play a disc recorded in NTSC color system.

Sound

There is no sound.

- ➔ Check that the player is connected securely.
- ➔ The audio connecting cord is damaged. Replace it with a new one.
- ➔ Make sure you connect the player to the audio input connectors on the receiver (amplifier). (page 12)
- ➔ Make sure you turn on the TV and the receiver (amplifier).
- ➔ Make sure you select the appropriate position on the receiver (amplifier) so that you can listen to the sound from the player.
- ➔ The player is in pause mode or in Slow-motion Play mode. Press ▷ to return to normal play mode.
- ➔ Fast forward (1▶▶ or 2▶▶) or fast reverse (1◀◀ or 2◀◀) is performed. Press ▷ to return to normal play mode.
- ➔ Check the speaker connections and settings. (page 14, 61) Refer to the operating manual of your receiver (amplifier).
- ➔ When you play the Dolby Digital/MPEG AUDIO sound tracks and attempt to output from the DIGITAL OUT connectors, set "DIGITAL OUT" to "ON" in the setup display. Otherwise no sound will come out from the DIGITAL OUT connectors. (page 59)
- ➔ When you play the DTS sound tracks, no sound will come out from the AUDIO OUT, 5.1CH OUTPUT and PHONES connectors. (page 59)

Sound noise is heard.

- ➔ Clean the disc.
- ➔ When you play the DTS sound tracks on a CD, sound noise will come out from the AUDIO OUT, 5.1CH OUTPUT and PHONES connectors. (page 59)

Sound distortion occurs.

- ➔ In the setup display, set "AUDIO ATT" in "AUDIO SETUP" to "ON."

The sound loses stereo effect when you play a VIDEO CD or a CD.

- ➔ Set "AUDIO" to "STEREO" in the Control Menu display. (page 33)
- ➔ Make sure you connect the player appropriately. (page 8, 12, 14)

The surround effect is difficult to hear when you are playing a Dolby Digital sound track.

- ➔ Check the speaker connections and settings. (page 14, 61) Refer to the operating manual of your receiver (amplifier).
- ➔ Depending on the DVD, the output signal may not be the entire 5.1 channel but monaural or stereo even if the sound track is recorded in Dolby Digital format.

The sound comes from the center speaker only.

- ➔ Depending on the disc, the sound may come from the center speaker only.
- ➔ Set "VIRTUAL 3D SURROUND" to "OFF," "VES A" or "VES B" in the Control Menu display. (page 36)

The sound comes from the front speaker only.

- ➔ You set "VIRTUAL 3D SURROUND" to "VES A" or "VES B" in the Control Menu display when you have connected the rear speakers (page 36). Select the other item.

Operation

The remote does not function.

- ➔ Remove any obstacles between the remote and the player.
- ➔ Use the remote near the player.
- ➔ Point the remote at the remote sensor  on the player.
- ➔ Replace all the batteries in the remote with new ones if they are weak.

The disc does not play.

- ➔ There is no disc inside (“Insert disc.” appears on the TV screen).
Insert a disc.
- ➔ Insert the disc correctly with the playback side facing down on the disc tray.
- ➔ Clean the disc.
- ➔ The player cannot play CD-ROMs, etc. (page 5)
Insert a DVD, a VIDEO CD, or CD.
- ➔ Check the region code of the DVD. (page 4)
- ➔ Moisture has condensed inside the player. Remove the disc and leave the player turned on for about half an hour. (page 6)

The player does not play from the beginning when playing a disc.

- ➔ Repeat Play, Shuffle Play or Program Play has been selected. Press CLEAR. (page 38 to 42)
- ➔ Resume Play has been selected.
Press ■ on the front panel or on the remote before you start playing. (page 20)
- ➔ A title menu or a DVD menu automatically appears on the TV screen when you play your DVD, or a setup display automatically appears on the TV screen when you play your VIDEO CD with PBC functions.

The player starts playing the DVD automatically.

- ➔ The DVD features the auto playback function.

Playback stops automatically.

- ➔ Depending on the disc, the auto pause signal is recorded. While playing such a disc, the player stops playback at the signal.

Stopping playback, Search, Slow-motion Play, Repeat Play, Shuffle Play or Program Play, etc., cannot be done.

- ➔ Depending on the disc, you may not do some of the operations above.

Messages do not appear on the TV screen in the language you want.

- ➔ In the setup display, select the language for the on-screen display in “OSD” under “LANGUAGE SETUP.” (page 52)

The language for the sound cannot be changed when you play a DVD.

- ➔ Multilingual sound is not recorded on the DVD.
- ➔ Changing the language for the sound is prohibited on the DVD.

The language for the subtitles cannot be changed when you play a DVD.

- ➔ Multilingual subtitles are not recorded on the DVD.
- ➔ Changing the language for the subtitles is prohibited on the DVD.

The subtitles cannot be turned off when you play a DVD.

- ➔ Depending on the DVD, you may not be able to turn the subtitles off.

The angles cannot be changed when you play a DVD.

- ➔ Multi-angles are not recorded on the DVD.
- ➔ Change the angles when “ANGLE” appears on the front panel display. (page 35)
- ➔ Changing the angles is prohibited on the DVD.

The player does not operate properly.

- ➔ Static electricity, etc., may affect the player's operation.
Disconnect the AC power cord once, then connect it again.

Nothing is displayed on the front panel display.

- ➔ In the set up display, “DIMMER” in “CUSTOM SETUP” is set to “OFF.”
Set “DIMMER” to “BRIGHT” or “DARK.” (page 55)

The disc tray does not open and “LOCKED” is displayed on the front panel display.

- ➔ Contact your Sony dealer or local authorized Sony service facility.

Self-diagnosis function

When the self-diagnosis function works to prevent the player from malfunctioning, a five-character service number (combination of a letter and digits) flashes on the front panel display. In this case, check the following table.

First three characters	Cause and/or Corrective Action
C13	<ul style="list-style-type: none">• The disc is dirty. ➡ Clean the disc with a cleaning cloth. (page 6)
C31	<ul style="list-style-type: none">• The disc is not inserted correctly. ➡ Open the disc tray and insert the disc correctly.
Exx (xx is any number)	<ul style="list-style-type: none">• To prevent the player from malfunctioning, the self-diagnosis function has worked. ➡ When you contact your Sony dealer or local authorized Sony service facility, give the 5-character service number. (example: E:61:10)

Specifications

CD/DVD player

Laser Semiconductor laser
 Signal format system PAL / (NTSC)

Audio characteristics

Frequency response
 DVD (PCM 96 kHz): 2 Hz to 44 kHz
 (± 0.5 dB)*
 DVD (PCM 48 kHz): 2 Hz to 22 kHz
 (± 0.5 dB)
 CD: 2 Hz to 20 kHz (± 0.5 dB)

Signal-to-noise ratio
 More than 110 dB (AUDIO OUT connector only)

Harmonic distortion
 Less than 0.0025%

Dynamic range
 More than 100 dB (DVD)
 More than 98 dB (CD)

Wow and flutter
 Less than detected value
 ($\pm 0.001\%$ W PEAK)

Outputs and inputs

	Jack type	Output level	Load impedance
AUDIO OUT	Phono jacks	2 V _{rms} (at 50 kilohms)	Over 10 kilohms
DIGITAL OUT (OPTICAL)	Optical output connector	-18 dBm	Wave length: 660 nm
DIGITAL OUT (COAXIAL)	Phono jack	0.5 V _{p-p}	75 ohms terminated
VIDEO OUT (1, 2)	Phono jacks	1.0 V _{p-p}	75 ohms, sync negative
S VIDEO OUT (1, 2)	4-pin mini DIN	Y: 1.0 V _{p-p} C: 0.3 V _{p-p} (PAL) 0.286 V _{p-p} (NTSC)	75 ohms, sync negative 75 ohms terminated
COMPONENT VIDEO OUT (Y, C _B /B-Y, C _R /R-Y)	Phono jacks	Y: 1.0 V _{p-p} C _B /B-Y, C _R /R-Y: 0.7 V _{p-p}	75 ohms, sync negative 75 ohms
PHONES	Phone jack	12 mW	32 ohms
5.1 OUTPUT	Phono jacks	2 V _{rms} (at 50 kilohms)	Over 10 kilohms

General

Power requirements
 220 - 240V AC, 50/60 Hz

Power consumption
 22 W

Dimensions (approx.)
 430 × 98 × 305 mm (w/h/d)
 incl. projecting parts

Mass (approx.)
 4.0 kg

Operating temperature
 5 °C to 35 °C

Operating humidity
 5% to 90%

Supplied accessories

See page 7.

* The signals from AUDIO OUT connector and 5.1 ch L,R connectors are measured. When you play the PCM sound tracks with 96 kHz sampling frequency, the output signals from the DIGITAL OUT (OPTICAL, COAXIAL) are converted to 48 kHz (sampling frequency).

Design and specifications are subject to change without notice.

Glossary

Bit rate (page 43)

Value indicating the amount of video data compressed in a DVD per second. The unit is Mbps (Mega bit per second). 1 Mbps indicates that the data per second is 1,000,000 bits. The higher the bit rate is, the larger the amount of data. However, this does not always mean that you can get higher quality pictures.

Chapter (page 5)

Sections of a picture or a music piece on a DVD that are smaller than titles. A title is composed of several chapters. Each chapter is assigned a chapter number enabling you to locate the chapter you want.

Digital Cinema Sound (DCS) (page 36)

The general name of technology that Sony developed to enjoy the surround sound in a home. To enjoy the surround sound of a movie theater in the comfort of your own home, it simulates the sound not in a concert hall as usual but in a movie editing studio. This player adopts VES (Virtual Enhanced Surround) system from various DCS programs. The VES system can create the sound image of virtual rear speakers from the sound of the front speakers (L, R) without using actual rear speakers.

Dolby Digital (page 14, 36)

Digital audio compression technology that the Dolby Laboratories Corporation developed. This technology conforms to 5.1-channel surround sound. The rear channel is stereo and there is discrete subwoofer channel in this format. Dolby Digital provides the same 5.1 discrete channels of high quality digital audio found in Dolby Digital cinema audio systems. The good channel separation is realized because the all channel data is recorded discrete and processed in digital.

Dolby Pro Logic (page 36, 59)

Audio signal processing technology that Dolby Laboratories Corporation developed for surround sound. When the input signal has the surround component, the Pro Logic process outputs the front, center and rear signals. The rear channel is monaural.

DTS (page 13)

Digital audio compression technology that the Digital Theater Systems, Inc. developed. This technology conforms to 5.1-channel surround. The rear channel is stereo and there is discrete subwoofer channel in this format. DTS provides the same 5.1 discrete channels of high quality digital audio. The good channel separation is realized because the all channel data is recorded discrete and processed in digital.

DVD (page 4)

A disc that contains up to 8 hours of moving pictures even though its diameter is the same as a CD.

The data capacity of a single-layer and single-sided DVD, at 4.7 GB (Giga Byte), is 7 times that of a CD.

Furthermore, the data capacity of a dual-layer and single-sided DVD is 8.5 GB, a single-layer and double-sided DVD 9.4 GB, and a dual-layer and double-sided DVD 17 GB.

The picture data uses the MPEG 2 format, one of the worldwide standards of digital compression technology. The picture data is compressed to about 1/40 of its original size. The DVD also uses the variable rate coding technology that changes the data to be allocated according to the status of the picture.

The audio data is recorded in Dolby Digital as well as in PCM, allowing you to enjoy more real audio presence. Furthermore, various advanced functions such as the multi-angle, multilingual, and Parental Control functions are provided with the DVD.

MPEG AUDIO (page 36)

International standard coding system to compress audio digital signals authorized by ISO/IEC. MPEG 1 conforms to up to 2-channel stereo. MPEG 2 used on DVDs conforms to up to 7.1-channel surround.

Multi-angle function (page 35)

Various angles, or viewpoints of the video camera, for a scene are recorded on some DVDs.

Multilingual function (page 16, 34, 52)

Several languages for the sound or sub-titles in a picture are recorded on some DVDs.

Parental Control (page 55)

A function of the DVD to limit playback of the disc by the age of the users according to the limitation level in each country. The limitation varies from disc to disc; when it is activated, playback is completely prohibited, violent scenes are skipped or replaced with other scenes and so on.

Playback Control (PBC) (page 22)

Signals encoded on VIDEO CDs (Version 2.0) to control playback.

By using menu screens recorded on VIDEO CDs with PBC functions, you can enjoy playing simple interactive programs, programs with search functions, and so on.

Title (page 5)

The longest sections of a picture or a music piece on a DVD; a movie, etc., for a picture piece on video software; or an album, etc., for a music piece on an audio software. Each title is assigned a title number enabling you to locate the title you want.

Track (page 5)

Sections of a picture or a music piece on a CD or VIDEO CD. Each track is assigned a track number enabling you to locate the track you want.

VIDEO CD (page 4)

A compact disc that contains moving pictures.

The picture data uses the MPEG 1 format, one of the worldwide standards of digital compression technology.

The picture data is compressed to about 1/140 of its original size. Consequently, a 12 cm VIDEO CD can contain up to 74 minutes of moving pictures.

VIDEO CDs also contain compact audio data. Sounds outside the range of human hearing are compressed while the sounds we can hear are not compressed. VIDEO CDs can hold 6 times the audio information of conventional audio CDs.

There are 2 versions of VIDEO CDs.

- Version 1.1: You can play only moving pictures and sounds.
- Version 2.0: You can play high-resolution still pictures and enjoy PBC functions.

This player conforms to both versions.

Language Code List

For details, see page 34, 52.

The language spellings conform to the ISO 639: 1988 (E/F) standard.

Code	Language	Code	Language	Code	Language	Code	Language
1027	Afar	1186	Scots Gaelic	1350	Malayalam	1513	Siswati
1028	Abkhazian	1194	Galician	1352	Mongolian	1514	Sesotho
1032	Afrikaans	1196	Guarani	1353	Moldavian	1515	Sundanese
1039	Amharic	1203	Gujarati	1356	Marathi	1516	Swedish
1044	Arabic	1209	Hausa	1357	Malay	1517	Swahili
1045	Assamese	1217	Hindi	1358	Maltese	1521	Tamil
1051	Aymara	1226	Croatian	1363	Burmese	1525	Telugu
1052	Azerbaijani	1229	Hungarian	1365	Nauru	1527	Tajik
1053	Bashkir	1233	Armenian	1369	Nepali	1528	Thai
1057	Byelorussian	1235	Interlingua	1376	Dutch	1529	Tigrinya
1059	Bulgarian	1239	Interlingue	1379	Norwegian	1531	Turkmen
1060	Bihari	1245	Inupiak	1393	Occitan	1532	Tagalog
1061	Bislama	1248	Indonesian	1403	(Afan) Oromo	1534	Setswana
1066	Bengali; Bangla	1253	Icelandic	1408	Oriya	1535	Tonga
1067	Tibetan	1254	Italian	1417	Punjabi	1538	Turkish
1070	Breton	1257	Hebrew	1428	Polish	1539	Tsonga
1079	Catalan	1261	Japanese	1435	Pashto; Pushto	1540	Tatar
1093	Corsican	1269	Yiddish	1436	Portuguese	1543	Twi
1097	Czech	1283	Javanese	1463	Quechua	1557	Ukrainian
1103	Welsh	1287	Georgian	1481	Rhaeto-Romance	1564	Urdu
1105	Danish	1297	Kazakh	1482	Kirundi	1572	Uzbek
1109	German	1298	Greenlandic	1483	Romanian	1581	Vietnamese
1130	Bhutani	1299	Cambodian	1489	Russian	1587	Volapük
1142	Greek	1300	Kannada	1491	Kinyarwanda	1613	Wolof
1144	English	1301	Korean	1495	Sanskrit	1632	Xhosa
1145	Esperanto	1305	Kashmiri	1498	Sindhi	1665	Yoruba
1149	Spanish	1307	Kurdish	1501	Sangho	1684	Chinese
1150	Estonian	1311	Kirghiz	1502	Serbo-Croatian	1697	Zulu
1151	Basque	1313	Latin	1503	Singhalese	1703	Not specified
1157	Persian	1326	Lingala	1505	Slovak		
1165	Finnish	1327	Laothian	1506	Slovenian		
1166	Fiji	1332	Lithuanian	1507	Samoan		
1171	Faroese	1334	Latvian; Lettish	1508	Shona		
1174	French	1345	Malagasy	1509	Somali		
1181	Frisian	1347	Maori	1511	Albanian		
1183	Irish	1349	Macedonian	1512	Serbian		

Index to Parts and Controls

Refer to the pages indicated in parentheses for details.

Front Panel

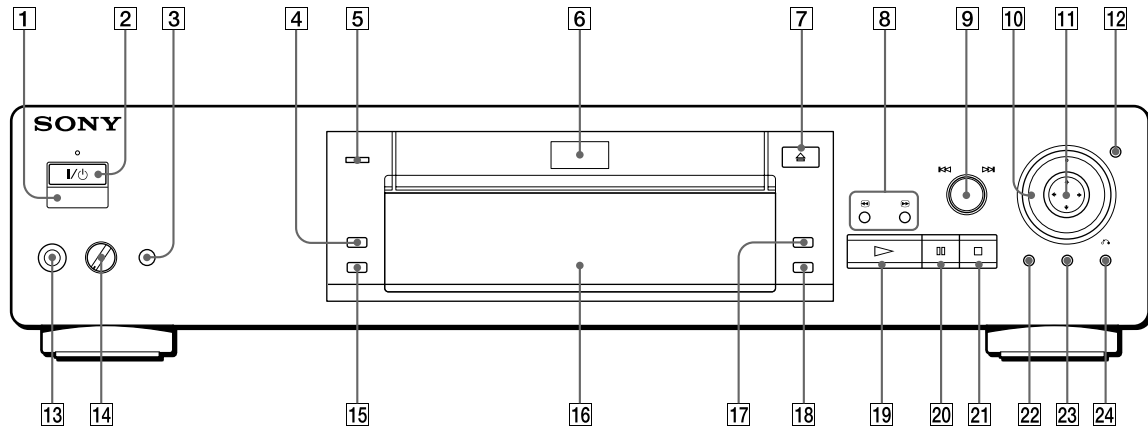

- | | |
|--|--|
| <p>1 (remote sensor) (7)
Accepts the remote control signals.</p> <p>2 I/⏻ (POWER) button and indicator (17)
Turns on and off the power of the player.</p> <p>3 VIRTUAL 3D SURROUND button/indicator (37)
Selects the item of "VIRTUAL 3D SURROUND." Each time you press the button, the item changes. When you do not set "VIRTUAL 3D SURROUND" to "OFF," the indicator lights up.</p> <p>4 SHUFFLE button (40)
Displays the "SHUFFLE" display on the TV screen.</p> <p>5 MULTICHANNEL indicator (36)
Lights up as follows:
- playing back multichannel surround sound such as Dolby Digital soundtrack and MPEG soundtrack
- the disc is not inserted</p> <p>6 Disc tray (17)
Place a disc on the tray.</p> <p>7 ≡ OPEN/CLOSE button (17)
Opens or closes the disc tray.</p> <p>8 ⏪/⏩ SEARCH buttons (19)
Press to locate a scene.</p> <p>9 ⏮/⏭ PREVIOUS/NEXT (DIRECT SEARCH dial) button (18)
Turn to select a chapter or track, and then press to go back to the selected chapter or track.</p> <p>10 Click shuttle (19)
Changes the playback speed.</p> <p>11 ⏪/⏩/⏮/⏭/ENTER button
Selects and executes the items or settings.</p> | <p>12 JOG button / indicator (19)
Press to play a disc frame by frame.</p> <p>13 PHONES connector (17)
Connect the headphones to this connector.</p> <p>14 PHONE LEVEL control (17)
Adjusts the headphone volume.</p> <p>15 PROGRAM button (38)
Displays the "PROGRAM" display on the TV screen.</p> <p>16 Front Panel Display (23)
Indicates the playing time, etc.</p> <p>17 REPEAT button (41)
Displays the "REPEAT" display on the TV screen.</p> <p>18 CLEAR button (39, 40, 41)
Press to return to the continuous play, etc.</p> <p>19 ▷ PLAY button (17)
Plays a disc.</p> <p>20 ■ PAUSE button (18)
Pauses playing a disc.</p> <p>21 ■ STOP button (18, 20)
Stops playing a disc.</p> <p>22 TITLE button (21)
Displays the title menu on the TV screen.</p> <p>23 DVD MENU button (21)
Displays the DVD menu on the TV screen.</p> <p>24 ⏪ RETURN button (22, 26)
Press to return to the previously selected screen, etc.</p> |
|--|--|

Rear Panel

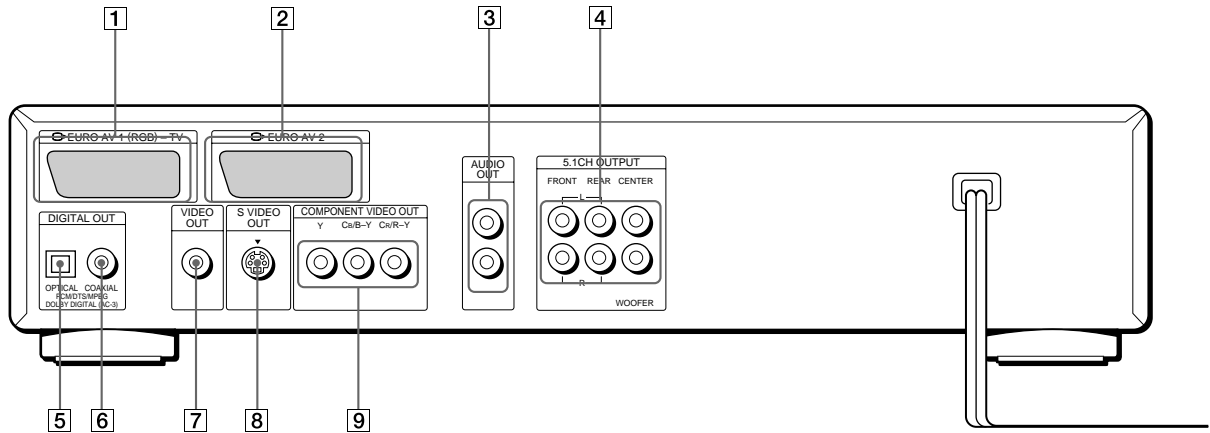

Additional Information

- 1** EURO AV 1 (RGB)-TV connector (8, 54)
Connects to the TV with EURO AV connector to output the signal from the player. You can select the video signals, the S VIDEO signals or the RGB signals as output signal format. Choose the appropriate one. (page 54)
- 2** EURO AV 2 connector (8)
Connects to the video equipment with EURO AV connector to input the signal from the equipment.
- 3** AUDIO OUT connectors (9, 12)
Connects to the audio input connector on the TV or receiver (amplifier).
- 4** 5.1CH OUTPUT connectors (15)
Connects to a receiver (amplifier) having 5.1 channel input connectors.
- 5** DIGITAL OUT (OPTICAL) connector (13)
Connects to an audio component using the optical digital connecting cord.
- 6** DIGITAL OUT (COAXIAL) connector (13)
Connects to an audio component using the coaxial digital connecting cord.
- 7** VIDEO OUT connectors (8)
Connects to the video input connector on the TV or monitor.
- 8** S VIDEO OUT (1, 2) connectors (8, 12)
Connects to the S video input connector on the TV or monitor.
- 9** COMPONENT VIDEO OUT connectors (9)
Connects to a monitor or projector having component video input connectors (Y, C_B/B-Y, C_R/R-Y) that conform to output signals from the player.

Remote

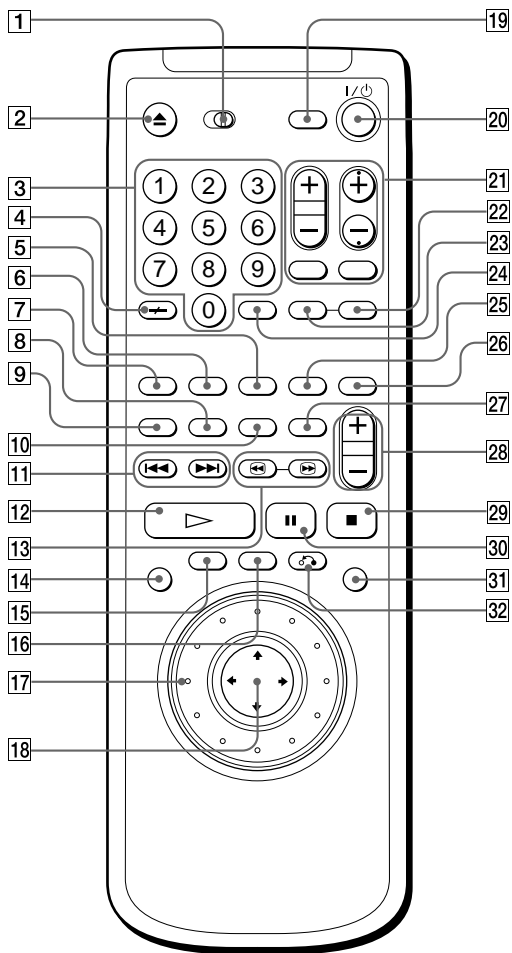

- 1 TV/DVD switch (63)**
Selects to control the player or the TV with the remote.
- 2 ▲OPEN/CLOSE button (17)**
Opens or closes the disc tray.
- 3 Number buttons**
Selects the items or settings.
- 4 CLEAR / -/-- (ten's digit)button (39, 40, 41)**
Press to return to the continuous play etc.
- 5 REPEAT button (41)**
Displays the "REPEAT" display on the TV screen.
- 6 PROGRAM button (38)**
Displays the "PROGRAM" display on the TV screen.
- 7 SHUFFLE button (40)**
Displays the "SHUFFLE" display on the TV screen.
- 8 ANGLE button (35)**
Changes the angles when playing a DVD.
- 9 AUDIO button (33)**
Changes the sound while playing a DVD or VIDEO CD.

- 10 SUBTITLE button (34)**
Displays the SUBTITLE menu in the Control Menu display.
- 11 ◀◀/▶▶PREV/NEXT buttons (18)**
Press to go to the next chapter or track or to go back to the previous chapter or track.
- 12 ▷PLAY button (17)**
Plays a disc.
- 13 🔍/🔍 (SEARCH) buttons (19)**
Press to locate a scene.
- 14 DISPLAY button (25)**
Displays the Control Menu display on the TV screen to set or adjust the items.
- 15 TITLE button (21)**
Displays the title menu on the TV screen.
- 16 DVD MENU button (21)**
Displays the DVD menu on the TV screen.
- 17 Click shuttle (19)**
Changes the playback speed.
- 18 ◀/▶/⬆/⬇/▶/▶/ ENTER button**
Selects and executes the items or settings.
- 19 SET UP button (49)**
Displays the setup display on the TV screen to set or adjust the items.
- 20 I/⏻ (POWER) button (17)**
Turns on and off the power of the player and TV.
- 21 TV operation buttons (63, 64)**
Controls TVs.
- 22 TIME/TEXT button (23)**
Displays the playing time of the disc, etc., on the front panel display.
- 23 INPUT button (32)**
Press when labeling a disc.
- 24 ENTER button**
Executes the items or settings.
- 25 PICTURE MEMORY button (54)**
Press to store a picture in memory.
- 26 TV/DVD button (64)**
Press to select the input source for the TV between the TV and CD/DVD player.
- 27 BOOK MARK button (48)**
Press to set a bookmark.
- 28 AV VOL button (64)**
Change the sound volume of the AV receivers (amplifiers).
- 29 ■STOP button (18, 20)**
Stops playing a disc.
- 30 ■■PAUSE button (18)**
Pauses playing a disc.
- 31 JOG button / indicator (19)**
Press to play a disc frame by frame.
- 32 ↶RETURN button (22, 26)**
Press to return to the previously selected screen, etc.

Index

Numerics

- 4:3 LETTER BOX 53
- 4:3 PAN SCAN 53
- 5.1 Channel Surround 14, 36
- 16:9 53

A

- A-B REPEAT 41
- A↔B Repeat 41
- ADVANCED 43
- Angle 35, 47
- ANGLE 35
- ANGLE VIEWER 47
- AUDIO 33, 52
- AUDIO ATT 58
- AUDIO DRC 58
- AUDIO FILTER 58
- AUDIO SETUP 58
- AUTO PLAY 54

B

- BACKGROUND 53
- BALANCE 62
- Batteries 7
- BOOKMARK 48
- BOOKMARK RESET 55

C

- CD 17
- Chapter 5, 28
- CHAPTER 28
- CHAPTER VIEWER 48
- COMPONENT OUT 10
- Connecting 8, 12, 14
- Continuous play
 - CD/VIDEO CD 17
 - DVD 17
- Control Menu display 25
- CUSTOM SETUP 54

D, E

- DIGITAL OUT 59
- Digital output 13, 59
- DIMMER 55
- Disc Memo 31
- Display
 - Control Menu display 25
 - Front panel display 23
 - Setup display 49
- DISTANCE 61
- DNR 45
- Dolby Digital 14, 36
- DTS 59
- DVD 17
- DVD menu 52

F, G

- Fast Forward 19
- Fast Reverse 19
- Front panel display 23

H, I, J, K

- Handling discs 6
- Hi-speed search 19
- Hooking up 8, 12, 14
- INDEX 28

L

- LANGUAGE SETUP 52
- LETTER BOX 53
- LEVEL 62
- Locating
 - a specific point 18
 - by observing the TV screen 19

M, N, O

- MPEG 60
- On-screen display
 - Control Menu display 25
 - Setup display 49
- OSD 52

P, Q

- PAN SCAN 53
- PARENTAL CONTROL 55
- PBC functions 22
- PBC Playback 22, 70
- PLAYBACK MEMORY 55
- PROGRAM 38
- PRO LOGIC 36
- Program Play 38

R

- Remote 7, 63
- REPEAT 41
- Resume Play 20

S

- S video output 8, 12
- Scene 5, 28
- SCENE 28
- SCREEN SAVER 53
- SCREEN SETUP 53
- Searching. See Locating.
- Setup display 49
- SHUFFLE 40
- Shuffle Play 40
- SIZE 61

- Slow-motion Play 19
- SPEAKER SETUP 61
- Speakers
 - hookup 15
 - set up 61
- STARTUP SCREEN 53
- STROBE PLAYBACK 47
- SUBTITLE 34

T

- TEST TONE 62
- TIME/MEMO 29, 30, 31
- TIME/TEXT 29, 30, 31
- Title 5, 28, 71
- TITLE 28
- Title menu 21
- TITLE VIEWER 48
- Track 5, 28, 71
- TRACK 28
- TRACK SELECTION 58
- TRACK VIEWER 48
- Troubleshooting 65
- TV TYPE 53

U

- Usable discs 4

V, W, X, Y, Z

- VES 36
- VIDEO CD 16
- VIDEO EQ 45
- VIRTUAL 3D SURROUND 36

