

# Home Theatre System

Operating Instructions

HT-DDWG700

## WARNING

**To reduce the risk of fire or electric shock, do not expose this apparatus to rain or moisture.**

To reduce the risk of fire, do not cover the ventilation opening of the apparatus with newspapers, tablecloths, curtains, etc. Do not place the naked flame sources such as lighted candles on the apparatus.

Do not install the appliance in a confined space, such as a bookcase or built-in cabinet.

To reduce the risk of fire or electric shock, do not expose this apparatus to dripping or splashing, and do not place objects filled with liquids, such as vases, on the apparatus.

As the main plug is used to disconnect the unit from the mains, connect the unit to an easily accessible AC outlet. Should you notice an abnormality in the unit, disconnect the main plug from the AC outlet immediately.

Do not expose batteries or apparatus with battery-installed to excessive heat such as sunshine, fire or the like.

The unit is not disconnected from the mains as long as it is connected to the AC outlet, even if the unit itself has been turned off.

Excessive sound pressure from earphones and headphones can cause hearing loss.

## About This Manual

- The instructions in this manual are for model HT-DDWG700. In this manual, models of area code AR2 is used for illustration purposes unless stated otherwise. Any difference in operation is clearly indicated in the text, for example, "Models of area code E51 only".

### The HT-DDWG700 consists of:

- Receiver STR-KG700
- Speaker system
  - Front speakers SS-MSP700
  - Center speaker SS-CNP700
  - Surround speakers SS-SRP700
  - subwoofer SS-WP700
- The instructions in this manual describe the controls on the supplied remote. You can also use the controls on the receiver if they have the same or similar names as those on the remote.

### About area codes

The area code of the receiver you purchased is shown on the lower right portion of the rear panel (see the illustration below).

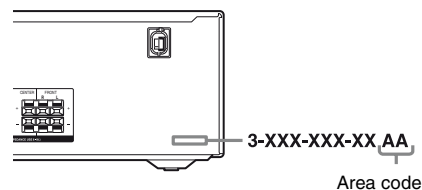

Any differences in operation, according to the area code, are clearly indicated in the text, for example, "Models of area code AA only".

This receiver incorporates Dolby\* Digital and Pro Logic Surround and the DTS\*\* Digital Surround System.

- \* Manufactured under license from Dolby Laboratories.  
Dolby, Pro Logic, and the double-D symbol are trademarks of Dolby Laboratories.
- \*\* Manufactured under license under U.S. Patent #'s: 5,451,942; 5,956,674; 5,974,380; 5,978,762; 6,487,535 & other U.S. and worldwide patents issued & pending. DTS and DTS Digital Surround are registered trademarks and the DTS logos and Symbol are trademarks of DTS, Inc.  
© 1996-2007 DTS, Inc. All Rights Reserved.

---

# Table of Contents

---

## Getting Started

|  |    |
|--|----|
| Description and location of parts .....  | 4  |
| 1: Installing the speakers.....  | 11 |
| 2: Connecting the speakers .....   | 13 |
| 3: Connecting the audio/video<br>components .....                                    | 14 |
| 4: Connecting the antennas .....   | 18 |
| 5: Preparing the receiver and the remote.....  | 19 |
| 6: Calibrating the appropriate settings<br>automatically<br>(AUTO CALIBRATION) ..... | 20 |
| 7: Adjusting the speaker levels and balance<br>(TEST TONE).....                      | 24 |

---

## Playback

|                                     |    |
|-------------------------------------|----|
| Selecting a component .....         | 25 |
| Listening/Watching a component..... | 26 |

---

## Amplifier Operations

|   |    |
|---|----|
| Navigating through menus .....  | 28 |
| Adjusting the level (LEVEL menu) .....                                    | 31 |
| Adjusting the tone (TONE menu) .....                                      | 32 |
| Settings for the surround sound<br>(SUR menu) .....                       | 32 |
| Settings for the tuner (TUNER menu) .....                                 | 33 |
| Settings for the audio (AUDIO menu) .....                                 | 33 |
| Settings for the system<br>(SYSTEM menu) .....                            | 34 |
| Calibrating the appropriate settings<br>automatically (A. CAL menu) ..... | 36 |

---

## Enjoying Surround Sound

|   |    |
|---|----|
| Enjoying Dolby Digital and DTS surround<br>sound (AUTO FORMAT DIRECT) ..... | 37 |
| Selecting a pre-programmed sound field.....                                 | 38 |
| Using only the front speakers and subwoofer<br>(2CH STEREO).....            | 40 |
| Resetting sound fields to the initial<br>settings.....                      | 40 |

---

## Tuner Operations

|                                |    |
|--------------------------------|----|
| Listening to FM/AM radio ..... | 41 |
| Presetting radio stations..... | 43 |

---

## Other Operations

|   |    |
|---|----|
| Switching between digital and analog audio<br>(INPUT MODE)..... | 45 |
| Enjoying the DIGITAL MEDIA PORT<br>(DMPORT).....                | 46 |
| Naming inputs .....   | 48 |
| Changing the display .....                                      | 49 |
| Using the Sleep Timer .....                                     | 49 |

---

## Using the Remote

|                                  |    |
|----------------------------------|----|
| Changing button assignments..... | 50 |
|----------------------------------|----|

---

## Additional Information

|                      |            |
|----------------------|------------|
| Glossary .....       | 51         |
| Precautions .....    | 52         |
| Troubleshooting..... | 54         |
| Specifications ..... | 57         |
| Index .....          | Back cover |

## Description and location of parts

### Receiver

#### Front panel

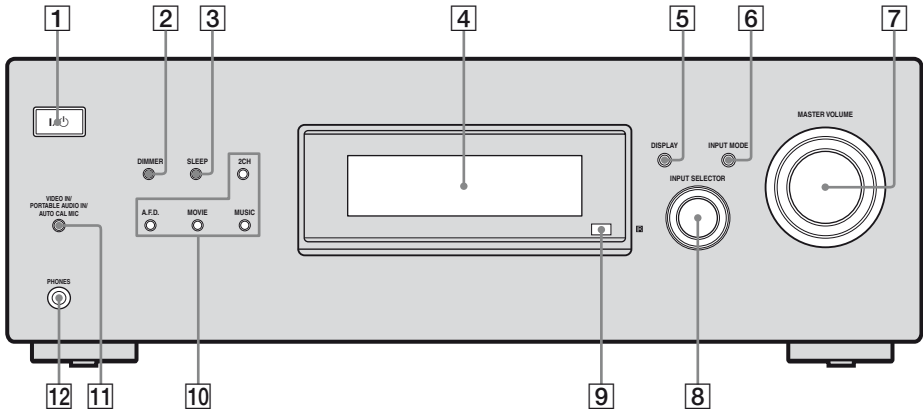

| Name            | Function  |
|-----------------|---|
| 1 I/O           | Press to turn the receiver on or off (page 19, 26, 27, 40).   |
| 2 DIMMER        | Press to adjust the brightness of the display.  |
| 3 SLEEP         | Press to activate the Sleep Timer function and the duration which the receiver turns off automatically (page 49). |
| 4 Display       | The current status of the selected component or a list of selectable items appears here (page 5).                 |
| 5 DISPLAY       | Press to select information displayed on the display (page 49).   |
| 6 INPUT MODE    | Press to select the input mode when the same components are connected to both digital and analog jacks (page 45). |
| 7 MASTER VOLUME | Turn to adjust the volume level of all speakers at the same time (page 24, 25, 26, 27).                           |

| Name  | Function   |
|---|--|
| 8 INPUT SELECTOR  | Turn to select the input source to play back (page 25).  |
| 9 Remote sensor   | Receives signals from remote commander.  |
| 10 2CH<br>A.F.D.<br>MOVIE<br>MUSIC                            | Press to select a sound field (page 37, 38, 40).   |
| 11 VIDEO IN/<br>PORTABLE<br>AUDIO IN/<br>AUTO CAL<br>MIC jack | <ul style="list-style-type: none"> <li>Connects to a portable audio such as MP3 player, etc. (page 15).</li> <li>Connects to the supplied optimizer microphone for the Auto Calibration function (page 21).</li> </ul> |
| 12 PHONES jack  | Connects to headphones (page 54).  |

## About the indicators on the display

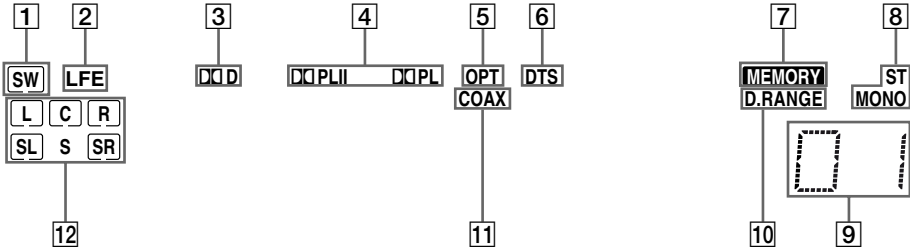

| Name                        | Function   |
|-----------------------------|--|
| <b>1 SW</b>                 | Lights up when the audio signal is output from the SUBWOOFER jack.   |
| <b>2 LFE</b>                | Lights up when the disc being played back contains an LFE (Low Frequency Effect) channel and the LFE channel signal is actually being reproduced.  |
| <b>3 DD D</b>               | Lights up when the receiver is decoding Dolby Digital signals.<br><b>Note</b><br>When playing a Dolby Digital format disc, be sure that you have made digital connections and that INPUT MODE is set to "AUTO" (page 45).        |
| <b>4 DD PL/<br/>DD PLII</b> | "DD PL" lights up when the receiver applies Pro Logic processing to 2 channel signals in order to output the center and surround channel signals.<br>"DD PLII" lights up when the Pro Logic II Movie/Music decoder is activated. |
| <b>5 OPT</b>                | Lights up when INPUT MODE is set to "AUTO" and the source signal is a digital signal being input through the OPTICAL jack.   |



| Name                               | Function  |
|------------------------------------|---|
| <b>6 DTS</b>                       | Lights up when the receiver is decoding DTS signals.<br><b>Note</b><br>When playing a DTS format disc, be sure that you have made digital connections and that INPUT MODE is set to "AUTO" (page 45). |
| <b>7 MEMORY</b>                    | Lights up when a memory function, such as Preset Memory (page 43), etc., is activated.  |
| <b>8 Tuner indicators</b>          | Lights up when using the receiver to tune in radio stations (page 41), etc.   |
| <b>9 Preset station indicators</b> | Lights up when using the receiver to tune in preset radio stations. For details on presetting radio stations, see page 43.  |
| <b>10 D.RANGE</b>                  | Lights up when dynamic range compression is activated (page 29).  |
| <b>11 COAX</b>                     | Lights up when DVD/BD input is selected. However, "UNLOCK" appears on the display if no digital signal is input through the COAXIAL jack.   |

| Name                                  | Function  |
|---------------------------------------|---|
| 12 <b>Playback channel indicators</b> | The letters (L, C, R, etc.) indicate the channels being played back. The boxes around the letters vary to show how the receiver downmixes the source sound. |
| <b>L</b>                              | Front Left  |
| <b>R</b>                              | Front Right   |
| <b>C</b>                              | Center (monaural)   |
| <b>SL</b>                             | Surround Left   |
| <b>SR</b>                             | Surround Right  |
| <b>S</b>                              | Surround (monaural or the surround components obtained by Pro Logic processing)   |
|                                       | <b>Example:</b>   |
|                                       | Recording format (Front/  |
|                                       | Surround): 3/2.1  |
|                                       | Sound Field: A.F.D. AUTO  |
|                                       |   |

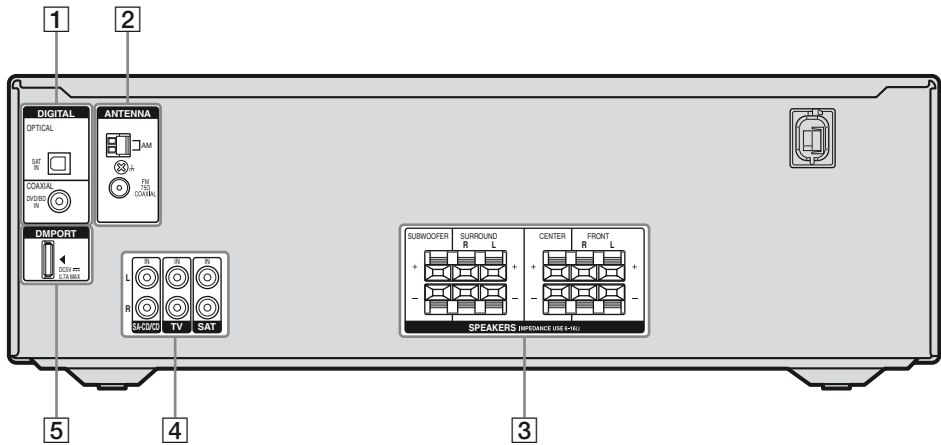

# Rear panel



## 1 DIGITAL INPUT section

- 
**OPTICAL IN jack** Connects to a DVD player, etc. The **COAXIAL** jack provides a better sound quality (page 17).
- 
**COAXIAL IN jack**

## 2 ANTENNA section

- 
**FM ANTENNA jack** Connects to the FM wire antenna supplied with this receiver (page 18).
- 
**AM ANTENNA terminals** Connects to the AM loop antenna supplied with this receiver (page 18).

## 3 SPEAKERS section

- 
**SPEAKERS** Connects to the speakers and subwoofer (page 13).

## 4 AUDIO INPUT section

- 
**White (L) AUDIO IN jacks** Connects to a CD player, etc. (page 15).
- 
**Red (R)**

## 5 DMPORT

- 
**DMPORT jack** Connects to a **DIGITAL MEDIA PORT** adapter (page 47).

## Remote commander

You can use the supplied RM-AAU025 Remote Commander to operate the receiver and to control the Sony audio/video components that the remote is assigned to operate (page 50).

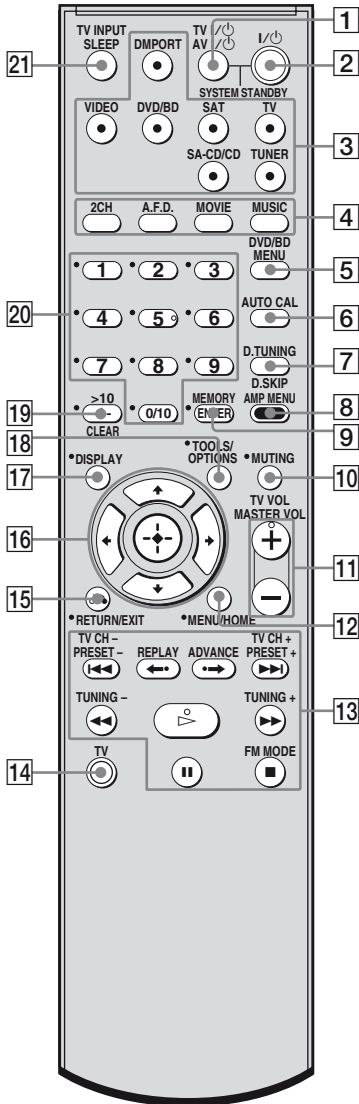

| Name                         | Function  |
|------------------------------|---|
| <b>1</b> TV I/⏻ (on/standby) | Press TV I/⏻ and TV (14) at the same time to turn the TV on or off.   |
| <b>AV I/⏻ (on/standby)</b>   | Press to turn on or off the Sony audio/video components that the remote is assigned to operate (page 50).<br>If you press I/⏻ (2) at the same time, it will turn off the receiver and other components (SYSTEM STANDBY).<br><b>Note</b><br>The function of the AV I/⏻ switch changes automatically each time you press the input buttons (3). |
| <b>2</b> I/⏻ (on/standby)    | Press to turn the receiver on or off.<br>To turn off all components, press I/⏻ and AV I/⏻ (1) at the same time (SYSTEM STANDBY).  |
| <b>3</b> Input buttons       | Press one of the buttons to select the component you want to use. When you press any of the input buttons, the receiver turns on. The buttons are factory assigned to control Sony components.<br>You can change the button assignments following the steps in "Changing button assignments" on page 50.                                      |
| <b>4</b> 2CH                 | Press to select a sound field.  |
| A.F.D.                       |   |
| MOVIE                        |   |
| MUSIC                        |   |
| <b>5</b> DVD/BD MENU         | Press to display the menu of the DVD or Blu-ray disc on the TV screen. Then, use ⬆, ⬇, ⬅, ➡ and Ⓢ (16) to perform menu operations.  |
| <b>6</b> AUTO CAL            | Press to activate the Auto Calibration function.  |
| <b>7</b> D.TUNING            | Press to enter direct tuning mode.  |
| D.SKIP                       | Press to skip a disc when using a multi-disc changer.   |



| Name   | Function   |
|--|--|
| <b>8</b> AMP MENU  | Press to display the menu of the receiver. Then, use $\uparrow$ , $\downarrow$ , $\leftarrow$ , $\rightarrow$ and $\oplus$ ( $\overline{16}$ ) to perform menu operations.   |
| <b>9</b> ENTER   | Press to enter the value after selecting a channel, disc or track using the numeric buttons of the TV, VCR or satellite tuner.   |
| <b>MEMORY</b>  | Press to store a station.  |
| <b>10</b> MUTING   | Press to turn off the sound temporarily.<br>Press MUTING again to restore the sound.<br>Press MUTING and TV ( $\overline{14}$ ) at the same time to activate the TV's muting function.   |
| <b>11</b> TV VOL + <sup>a</sup> /-<br>MASTER VOL + <sup>a</sup> /-           | Press TV VOL +/- and TV ( $\overline{14}$ ) at the same time to adjust the volume level of the TV.<br>Press to adjust the volume level of all speakers at the same time.   |
| <b>12</b> MENU/HOME  | Press to display the menu of the VCR, DVD player, satellite tuner or Blu-ray disc player on the TV screen.<br>Press MENU/HOME and TV ( $\overline{14}$ ) at the same time to display the TV's menu.<br>Then, use $\uparrow$ , $\downarrow$ , $\leftarrow$ , $\rightarrow$ and $\oplus$ ( $\overline{16}$ ) to perform menu operations. |
| <b>13</b> $\lll / \ggg$ <sup>b</sup>   | Press to skip a track of the CD player, DVD player or Blu-ray disc player.   |
| <b>REPLAY <math>\leftarrow</math> /<br/>ADVANCE <math>\rightarrow</math></b> | Press to replay the previous scene or fast forward the current scene of the VCR, DVD player or Blu-ray disc player.  |
| $\lll / \ggg$ <sup>b</sup>   | Press to<br>– search tracks in the forward/reverse direction of the DVD player.<br>– start fast forward/rewind of the VCR, CD player or Blu-ray disc player.   |
| $\triangleright$ <sup>a</sup> <sup>b</sup>                                   | Press to start playback of the VCR, CD player, DVD player, or Blu-ray disc player.   |

| Name   | Function   |
|--|--|
| $\parallel$ <sup>b</sup>   | Press to pause playback or recording of the VCR, CD player, DVD player or Blu-ray disc player. (Also starts recording with components in recording standby.)   |
| $\blacksquare$ <sup>b</sup>  | Press to stop playback of the VCR, CD player, DVD player or Blu-ray disc player.   |
| <b>TV CH +/-</b>   | Press TV CH +/- and TV ( $\overline{14}$ ) at the same time to select preset TV channels.  |
| <b>PRESET +/-</b>  | Press to select<br>– preset stations.<br>– preset channels of the VCR or satellite tuner.  |
| <b>TUNING +/-</b>  | Press to scan a station.   |
| <b>FM MODE</b>   | Press to select the FM monaural or stereo reception.   |
| <b>14</b> TV   | Press TV and the buttons with orange printing at the same time to enable the TV operation.   |
| <b>15</b> RETURN/<br>EXIT $\curvearrowright$                             | Press to<br>– return to the previous menu.<br>– exit the menu while the menu or on-screen guide of the VCR, DVD player, satellite tuner or Blu-ray disc player is displayed on the TV screen.<br>Press RETURN/EXIT $\curvearrowright$ and TV ( $\overline{14}$ ) at the same time to return to the previous menu or exit the TV's menu while the menu is displayed on the TV screen.   |
| <b>16</b> $\oplus$<br>$\uparrow / \downarrow / \leftarrow / \rightarrow$ | After pressing DVD/BD MENU ( $\overline{5}$ ), AMP MENU ( $\overline{8}$ ), or MENU/HOME ( $\overline{12}$ ), press $\uparrow$ , $\downarrow$ , $\leftarrow$ or $\rightarrow$ to select the settings. Then, press $\oplus$ to enter the selection if you have pressed DVD/BD MENU or MENU/HOME previously. Press $\oplus$ also to enter the selection of the receiver, VCR, satellite tuner, CD player, DVD player or Blu-ray disc player. |

continued

| <b>Name</b>                                      | <b>Function</b>   |
|--|---|
| <b>17 DISPLAY</b>                                | Press to select information displayed on the TV screen of the VCR, satellite tuner, CD player, DVD player or Blu-ray disc player.<br>Press DISPLAY and TV ( <b>14</b> ) at the same time to display TV's information on the TV screen.  |
| <b>18 TOOLS/OPTIONS</b>                          | Press to display and select the options of the DVD player or Blu-ray disc player.<br>Press TOOLS/OPTIONS and TV ( <b>14</b> ) at the same time to display the options applicable to the Sony TV.  |
| <b>19 -/--</b>                                   | Press to select the channel entry mode, either one or two digit of the VCR.<br>Press -/-- and TV ( <b>14</b> ) at the same time to select the channel entry mode, either one or two digits of the TV.   |
| <b>&gt;10</b>                                    | Press to select track numbers over 10 of the CD player.   |
| <b>CLEAR</b>                                     | Press to clear a mistake when you press the incorrect numeric button.   |
| <b>20 Numeric buttons (number 5<sup>a</sup>)</b> | Press to<br>– preset/tune to preset stations.<br>– select track numbers of the CD player, DVD player or Blu-ray disc player. Press 0/10 to select track number 10.<br>– select channel numbers of the VCR or satellite tuner.<br>Press the numeric buttons and TV ( <b>14</b> ) at the same time to select the TV channels. |
| <b>21 TV INPUT</b>                               | Press TV INPUT and TV ( <b>14</b> ) at the same time to select the input signal (TV input or video input).  |
| <b>SLEEP</b>                                     | Press to activate the Sleep Timer function and the duration which the receiver turns off automatically.   |

- a) The number 5, MASTER VOL +, TV VOL +, and  $\triangleright$  buttons have tactile dots. Use the tactile dots as references when operating the receiver.
- b) This button is also available for DIGITAL MEDIA PORT adapter operation. For details on the function of the button, see the operating instructions supplied with the DIGITAL MEDIA PORT adapter.

### Notes

- Some functions explained in this section may not work depending on the model.
- The above explanation is intended to serve as an example only. Therefore, depending on the component, the above operation may not be possible or may operate differently than described.

# 1: Installing the speakers

To fully enjoy theater-like multi channel surround sound requires five speakers (two front speakers, a center speaker, and two surround speakers) and a subwoofer (5.1 channel).

## Example of a 5.1 channel speaker system configuration

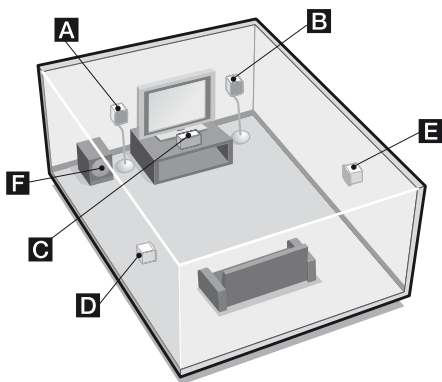

- A** Front speaker (left)
- B** Front speaker (right)
- C** Center speaker
- D** Surround speaker (left)
- E** Surround speaker (right)
- F** Subwoofer

### Tip

Since the subwoofer does not emit highly directional signals, you can place it wherever you want.

## Installing the speakers on a flat surface

Before you install the speakers and subwoofer, be sure to attach the supplied foot pads to prevent vibration or movement as shown in the illustration below.

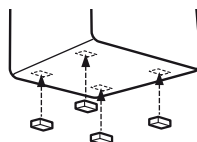

## Installing the speakers on the speaker stand

For greater flexibility in positioning the speakers, use the optional WS-FV11 or WS-FV10D speaker stand (available only in certain countries). Be sure to detach the screw from the speaker and use it when you install the speaker to the speaker stand. For details, refer to the operating instructions supplied with the speaker stand.

## Installing the speakers on the wall

You can install your front and surround speakers on the wall.

- 1 Prepare screws (not supplied) that are suitable for the hook on the back of each speaker as shown in the illustrations below.**

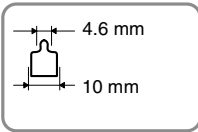
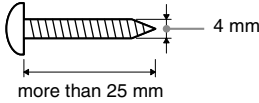

Hook on the back of the speaker

- 2 Fasten the screws to the wall. The screws should protrude 5 to 7 mm.**

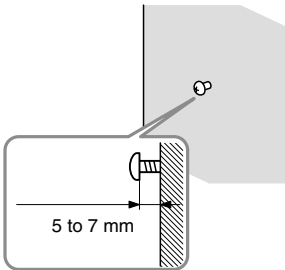

- 3 Hang the speakers on the screws.**

Hook on the back of the speaker

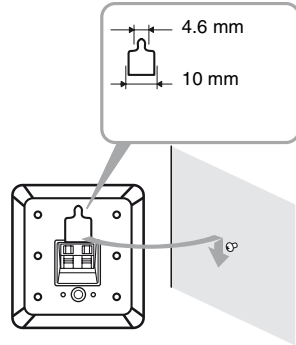

### Notes

- Use screws that are suitable for the wall material and strength. As a plaster board wall is especially fragile, attach the screws securely to a beam and fasten them to the wall. Install the speakers on a vertical and flat wall where reinforcement is applied.
- Contact a screw shop or installer regarding the wall material or screws to be used.
- Sony is not responsible for accident or damage caused by improper installation, insufficient wall strength or improper screw installation, natural calamity, etc.

## 2: Connecting the speakers

Before connecting the cords, be sure to disconnect the AC power cord (mains lead).

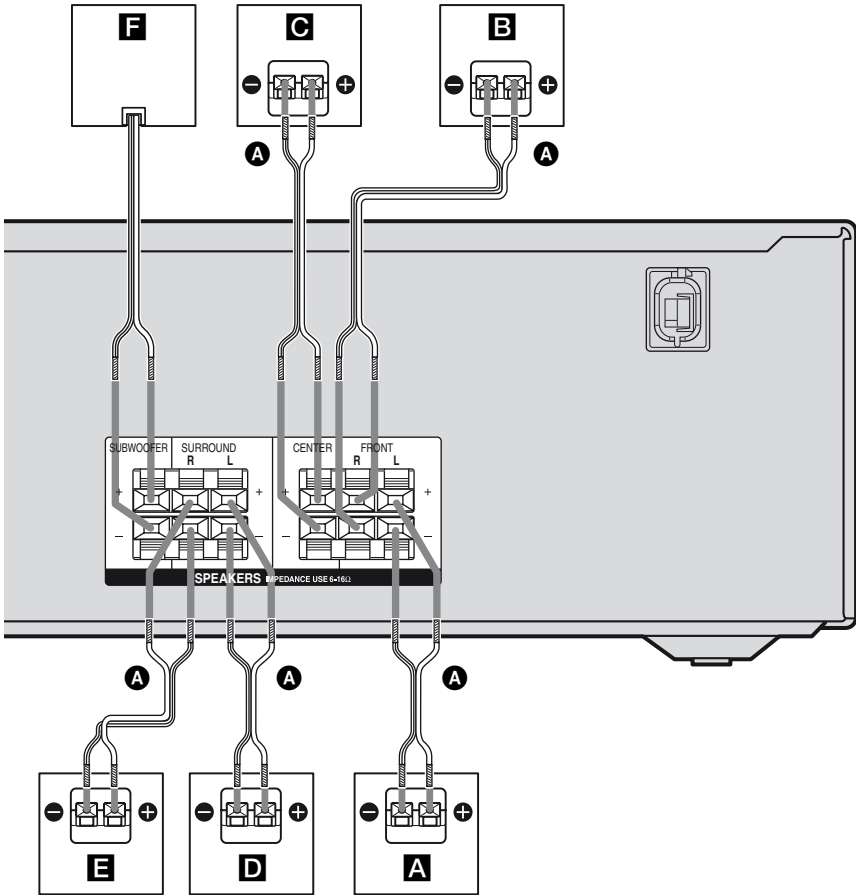

**A** Speaker cord (supplied)\*

**A** Front speaker (left)

**B** Front speaker (right)

**C** Center speaker

**D** Surround speaker (left)

**E** Surround speaker (right)

**F** Subwoofer

\* Use the long speaker cords to connect the surround speakers and the short speaker cords to connect the front and center speakers.

## To connect the speakers correctly

Check the speaker type by referring to the speaker label\* at the rear panel or bottom of the speakers.

| Character on speaker label | Speaker type   |
|----------------------------|----------------|
| L                          | Front left     |
| R                          | Front right    |
| SL                         | Surround left  |
| SR                         | Surround right |

\* The center speaker and subwoofer do not have any character on the speaker label. For details on the speaker type, see page 2.

### Tip

Use the supplied speakers to optimize the system's performance.

## 3: Connecting the audio/video components

### How to connect your components

This section describes how to hook up your components to this receiver. Before you begin, refer to "Component to be connected" below for the pages which describe how to connect the audio/video components.

After connect all your components, proceed to "4: Connecting the antennas" (page 18).

### Component to be connected

| To connect  | See     |
|---|---------|
| Audio components <ul style="list-style-type: none"><li>• Super Audio CD player/CD player</li><li>• Portable audio such as MP3 player, etc.</li></ul>              | page 15 |
| Video components <ul style="list-style-type: none"><li>• DVD player/DVD recorder/Blu-ray disc player</li><li>• Satellite tuner/Set-top box</li><li>• TV</li></ul> | page 17 |

## Connecting audio components

Before connecting the cords, be sure to disconnect the AC power cord (mains lead).

The following illustration shows how to connect audio components such as MP3 player, Super Audio CD player or CD player.

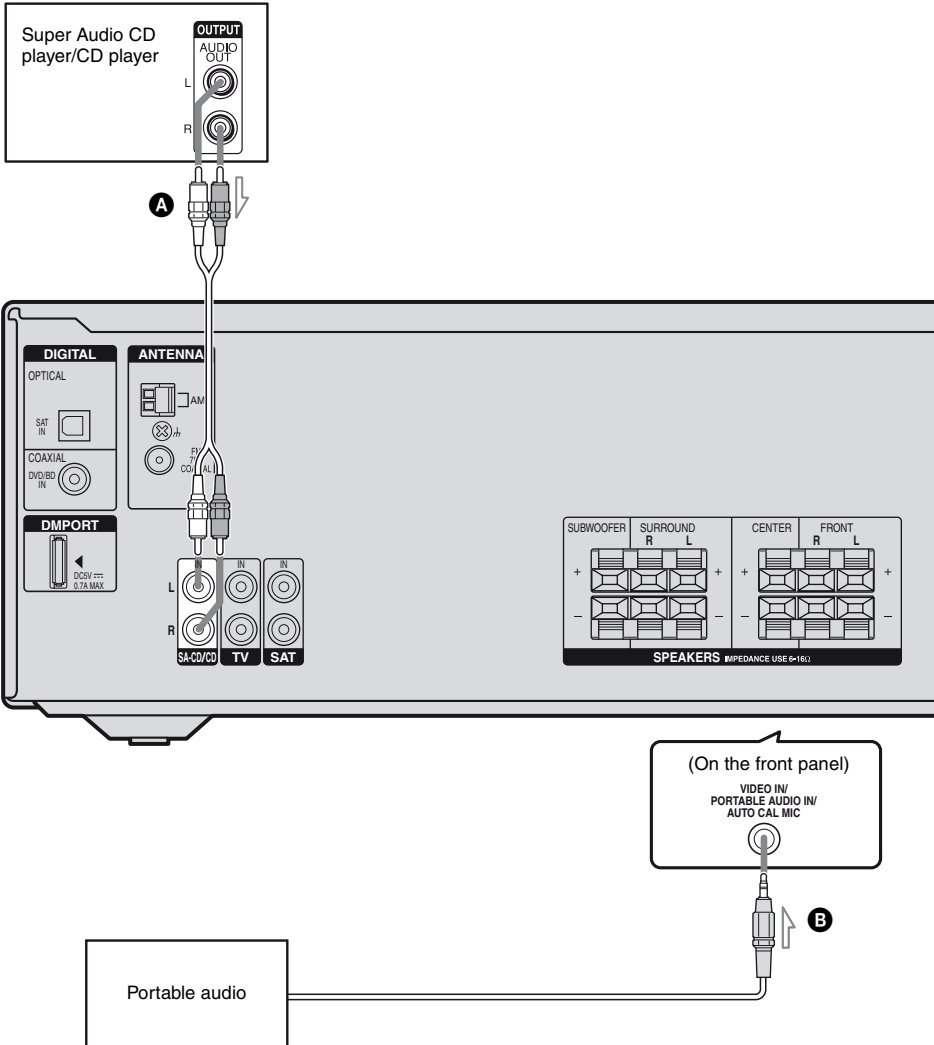

**A** Audio cord (not supplied)

**B** Phono cord with stereo headphone jack (not supplied)

## Notes

- When listening to a component connected to the VIDEO IN/PORTABLE AUDIO IN/AUTO CAL MIC jack, sound may be distorted or interrupted. This is not a malfunction and will depend on the connected component.
- If the sound from the component connected to the VIDEO IN/PORTABLE AUDIO IN/AUTO CAL MIC jack is very soft, you may increase the volume level. However, before you select other component, be sure to reduce the volume level to avoid damaging your speaker.

## Tip

You are recommended to use “PORTABLE” sound field if the source is MP3 or other compressed source.



## Connecting video components

Before connecting the cords, be sure to disconnect the AC power cord (mains lead).

The following illustration shows how to connect video components such as DVD player, Blu-ray disc player, satellite tuner, etc.

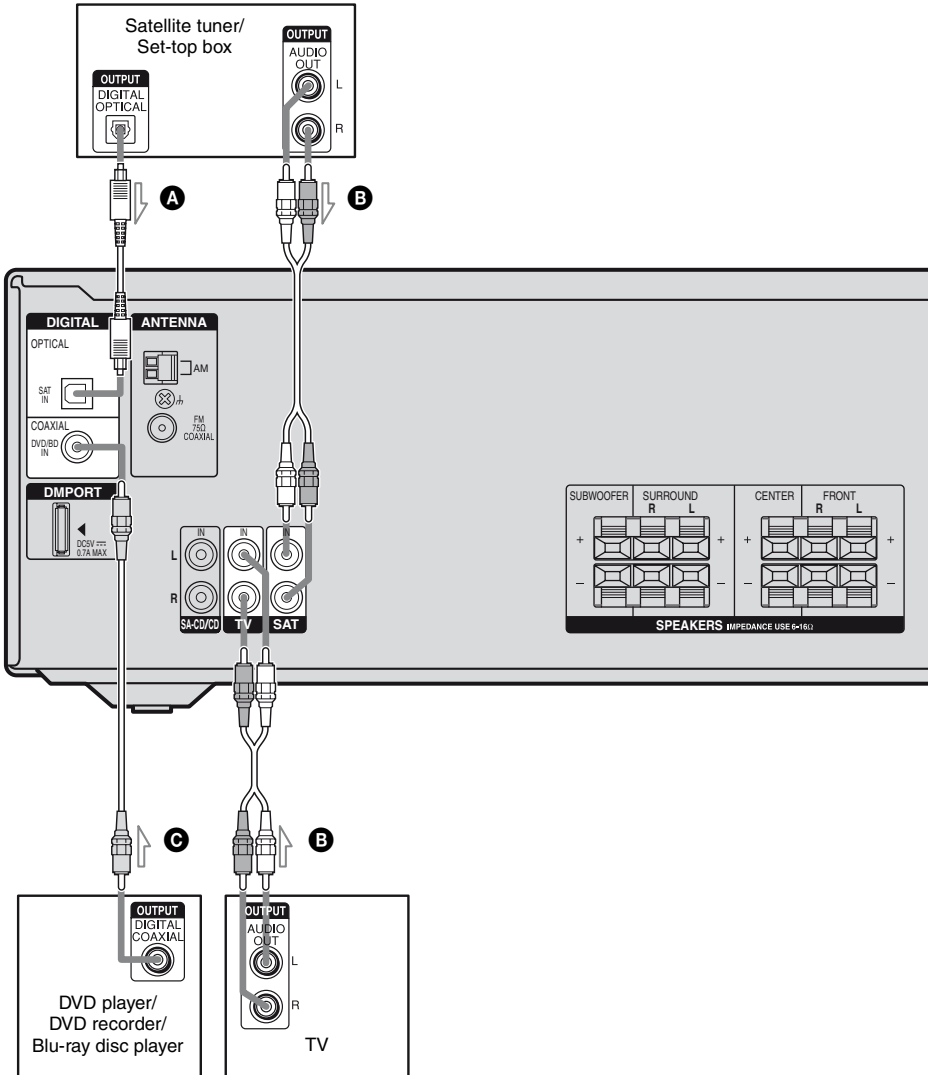

## If you connect a DVD player or Blu-ray disc player

- Be sure to change the factory setting of the DVD/BD input button on the remote so that you can use the button to control your DVD player or Blu-ray disc player. For details, see “Changing button assignments” (page 50).
- You can also rename the DVD/BD input so that it can be displayed on the receiver’s display. For details, see “Naming inputs” (page 48).

### Notes

- To input multi channel digital audio from the DVD player, DVD recorder or Blu-ray disc player, set the digital audio output setting on the DVD player, DVD recorder or Blu-ray disc player. Refer to the operating instructions supplied with the DVD player, DVD recorder or Blu-ray disc player.
- To output sound from the front speakers and the subwoofer only when you select DVD/BD input, be sure to:
  - connect your DVD player, DVD recorder or Blu-ray disc player to the DIGITAL COAXIAL DVD/BD IN jack on the receiver.
  - press 2CH.
- When connecting optical digital cords, insert the plugs straight in until they click into place.
- Do not bend or tie optical digital cords.
- Be sure to connect the video output of the DVD player/DVD recorder/Blu-ray disc player and satellite tuner/set-top box to the TV, so that the image is displayed on the TV. Refer to the operating instructions of each component connected for details.
- You cannot do recording on the DVD recorder via this receiver. For details, refer to the operating instructions supplied with the DVD recorder.

### Tips

- All the digital audio jacks are compatible with 32 kHz, 44.1 kHz, 48 kHz, and 96 kHz sampling frequencies.
- To output the sound of the TV from the speakers connected to the receiver, be sure to:
  - connect the audio output jacks of the TV to the TV IN jacks of the receiver.
  - turn off the TV’s volume or activate the TV’s muting function.

## 4: Connecting the antennas

Connect the supplied AM loop antenna and FM wire antenna.

Before connecting the antennas, be sure to disconnect the AC power cord (mains lead).

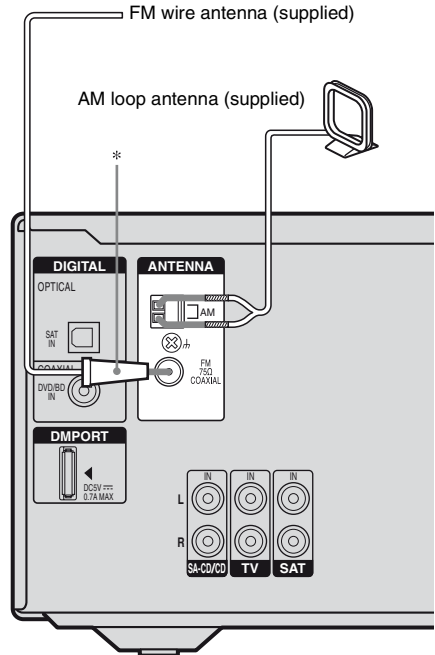

\* The shape of the connector varies depending on the area code of this receiver.

### Notes

- To prevent noise pickup, keep the AM loop antenna away from the receiver and other components.
- Be sure to fully extend the FM wire antenna.
- After connecting the FM wire antenna, keep it as horizontal as possible.

## 5: Preparing the receiver and the remote

### Setting the voltage selector

If your receiver has a voltage selector on the rear panel, check that the voltage selector is set to the local power supply voltage. If not, use a screwdriver to set the selector to the correct position before connecting the AC power cord to a wall outlet.

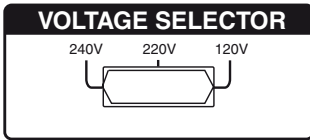

### Connecting the AC power cord (mains lead)

Connect the AC power cord (mains lead) to a wall outlet.

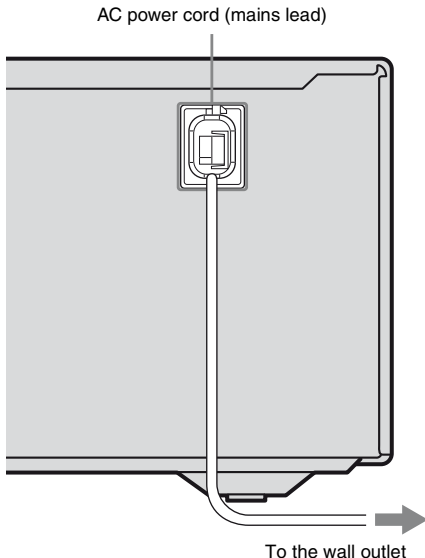

### Performing initial setup operations

Before using the receiver for the first time, initialize the receiver by performing the following procedure. This procedure can also be used to return settings you have made to their factory defaults.

Be sure to use the buttons on the receiver for this operation.

## 1,2

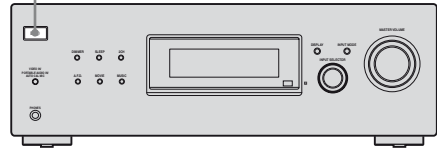

- 1** Press I/⏻ to turn off the receiver.
- 2** Hold down I/⏻ for 5 seconds.

After “CLEARING” appears on the display for a while, “CLEARED” appears.

All the settings you have changed or adjusted are reset to the initial settings.

## Inserting batteries into the remote

Insert two R6 (size-AA) batteries in the RM-AAU025 Remote Commander. Observe the correct polarity when installing batteries.

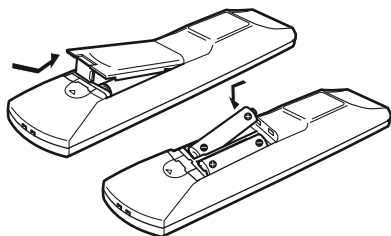

### Notes

- Do not leave the remote in an extremely hot or humid place.
- Do not use a new battery with old ones.
- Do not mix manganese batteries and other kinds of batteries.
- Do not expose the remote sensor to direct sunlight or lighting apparatuses. Doing so may cause a malfunction.
- If you do not intend to use the remote for an extended period of time, remove the batteries to avoid possible damage from battery leakage and corrosion.
- When you replace the batteries, the remote buttons may be reset to their factory settings. If this happens, reassign the button again (page 50).
- When the remote no longer operates the receiver, replace all the batteries with new ones.

## 6: Calibrating the appropriate settings automatically (AUTO CALIBRATION)

The DCAC (Digital Cinema Auto Calibration) function allows you to perform automatic calibration such as:

- Checking the connection between each speaker and the receiver.
- Adjusting the speaker level.
- Measuring the distance of each speaker from your listening position.

You can also adjust the speaker levels and balance manually. For details, see “7: Adjusting the speaker levels and balance (TEST TONE)” (page 24).

### Before you perform Auto Calibration

Before you perform Auto Calibration, install and connect the speakers (page 11, 13).

- The VIDEO IN/PORTABLE AUDIO IN/AUTO CAL MIC jack is used for the supplied optimizer microphone only. Do not connect other microphones to this jack. Doing so may damage the receiver and the microphone.
- During calibration, the sound that comes out of the speakers is very loud. The volume of the sound cannot be adjusted. Pay attention to the presence of children or to the effect on your neighborhood.
- Perform Auto Calibration in a quiet environment to avoid the effect of noise and to get a more accurate measurement.
- If there are any obstacles in the path between the optimizer microphone and the speakers, the calibration cannot be performed correctly. Remove any obstacles from the measurement area to avoid measurement error.

## Notes

- The Auto Calibration function does not work when headphones are connected.
- If the muting function is on when we perform Auto Calibration, the muting function will turn off automatically.

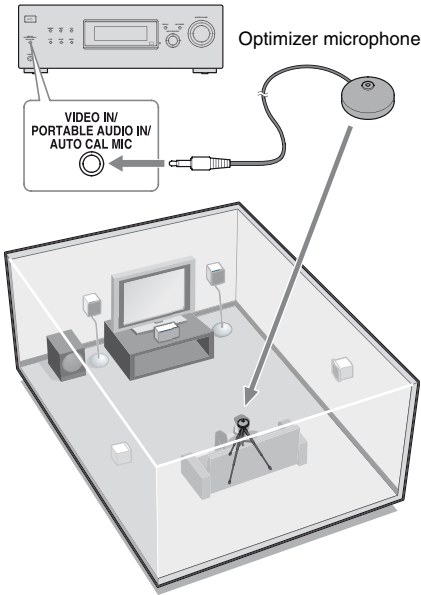

- 1 Connect the supplied optimizer microphone to the VIDEO IN/PORTABLE AUDIO IN/AUTO CAL MIC jack.**

- 2 Set up the optimizer microphone.**

Place the optimizer microphone at your listening position. You can also use a stool or tripod (not supplied) so that the optimizer microphone remains at the same height as your ears.

## Performing Auto Calibration

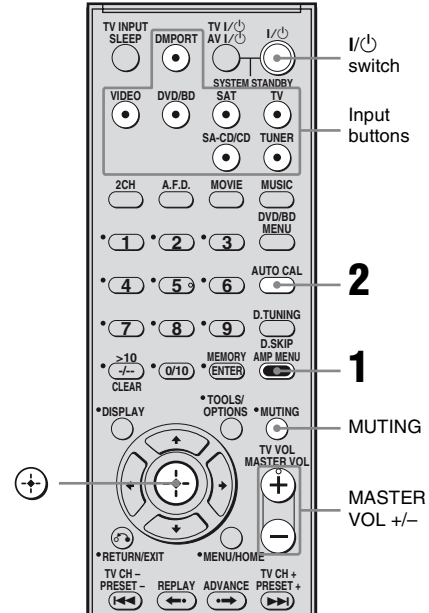

- 1 Press AMP MENU.**

- 2 Press AUTO CAL.**

Measurement starts in 5 seconds and the display changes as follows:

A.CAL [5] → A.CAL [4] → A.CAL [3]  
→ A.CAL [2] → A.CAL [1]

While the time is counting down, stand away from the measurement area to avoid measurement error.

### 3 Measurement starts.

The measurement process will take a few minutes to complete.

The table below shows the display when measurement starts.

| Measurement for         | Display                                   |
|-------------------------|---|
| Environment noise level | NOISE.CHK                                 |
| Speaker connection      | MEASURE and SP DET. appears alternately*  |
| Speaker level           | MEASURE and GAIN appears alternately*     |
| Speaker distance        | MEASURE and DISTANCE appears alternately* |

\* The corresponding speaker indicator lights up in the display during measurement.

### 4 Measurement ends.

“COMPLETE” appears on the display and the settings are registered.

### After you have finished

Disconnect the optimizer microphone from the VIDEO IN/PORTABLE AUDIO IN/AUTO CAL MIC jack.

#### Notes

- Auto Calibration cannot detect the subwoofer. Therefore, all subwoofer settings will be maintained.
- If you have changed the position of the speakers, it is recommended that you perform Auto Calibration again to enjoy the surround sound.

#### Tips

- When Auto Calibration starts:
  - Stand some distance from the speakers and the listening position to avoid measurement failure. This is because test signals are output from the speakers during measurement.
  - Avoid making noise to get a more accurate measurement.
- During the measurement process, Auto Calibration is canceled when you do the following.
  - Press I/⏻ or MUTING.
  - Press the input buttons or turn the INPUT SELECTOR on the receiver.
  - Change the volume level.
  - Connect the headphones.
  - Press AUTO CAL again.

### Error and warning codes

#### When error codes appear

When an error is detected during Auto Calibration, an error code will appear on the display cyclically after each measurement process as follows:

Error code → blank display → (error code → blank display)<sup>a)</sup> → PUSH → blank display → ENTER

<sup>a)</sup> Appears when there are more than one error code.

#### To rectify the error

- 1 Record down the error code.
- 2 Press ⊕.
- 3 Press I/⏻ to turn off the receiver.
- 4 Rectify the error.  
For details, see “Error codes and remedies” below.
- 5 Turn on the receiver and perform Auto Calibration again (page 21).

## Error codes and remedies

| Error code | Cause and remedy   |
|------------|--|
| ERROR 10   | The environment is too noisy. Make sure the environment is quiet during Auto Calibration.  |
| ERROR 11   | The speakers are placed too near the optimizer microphone. Place your speakers further away from the optimizer microphone.           |
| ERROR 12   | None of the speakers are detected. Make sure that the optimizer microphone is connected properly and perform Auto Calibration again. |
| ERROR 20   | Front speakers are not detected or only one front speaker is detected. Check the front speaker connection.                           |
| ERROR 21   | Only one surround speaker is detected. Check the surround speaker connection.  |

### When warning codes appear

During Auto Calibration, the warning code provides information on the measurement result. The warning code will appear on the display cyclically as follows:

Warning code → blank display → (warning code → blank display)<sup>b)</sup> → PUSH → blank display → ENTER

<sup>b)</sup>Appears when there are more than one warning code.

You can choose to ignore the warning code as the Auto Calibration function will automatically adjust the settings. You can also change the settings manually.

### To change the settings manually

- 1 Record down the warning code.
- 2 Press ⊕.
- 3 Press I/⏻ to turn off the receiver.
- 4 Follow the solution provided in the “Warning codes and solutions” below.
- 5 Turn on the receiver and perform Auto Calibration again (page 21).

## Warning codes and solutions

| Warning code | Explanation and solution   |
|--------------|--|
| WARN. 40     | The environment is noisy. Make sure the environment is quiet during Auto Calibration.                      |
| WARN. 50     | The center speaker is not connected. Be sure to connect the center speaker.                                |
| WARN. 51     | The surround speakers are not connected. Be sure to connect the surround speakers.                         |
| WARN. 60     | The front speaker balance is out of range. Reposition your front speakers. <sup>c)</sup>                   |
| WARN. 62     | The center speaker level is out of range. Reposition your center speaker. <sup>d)</sup>                    |
| WARN. 63     | The surround left speaker level is out of range. Reposition your surround left speaker. <sup>d)</sup>      |
| WARN. 64     | The surround right speaker level is out of range. Reposition your surround right speaker. <sup>d)</sup>    |
| WARN. 70     | The front speaker distance is out of range. Reposition your front speakers. <sup>c)</sup>                  |
| WARN. 72     | The center speaker distance is out of range. Reposition your center speaker. <sup>d)</sup>                 |
| WARN. 73     | The surround left speaker distance is out of range. Reposition your surround left speaker. <sup>d)</sup>   |
| WARN. 74     | The surround right speaker distance is out of range. Reposition your surround right speaker. <sup>d)</sup> |

<sup>c)</sup>For details, refer “Front speaker distance” (page 34).

<sup>d)</sup>For details, refer “Tip” on page 35.

# 7: Adjusting the speaker levels and balance (TEST TONE)

You can adjust the speaker levels and balance while listening to the test tone from your listening position.

### Tip

The receiver employs a test tone with a frequency centered at 800 Hz.

## 5 Press $\uparrow/\downarrow$ repeatedly to select “T. TONE Y”.

The test tone is output from each speaker in sequence as follows:

Front left → Center → Front right → Surround right → Surround left → subwoofer

## 6 Adjust the speaker levels and balance using the LEVEL menu so that the level of the test tone sounds the same from each speaker.

For details, see “Adjusting the level (LEVEL menu)” (page 31).

### Tips

- To adjust the level of all speakers at the same time, press MASTER VOL +/- . You can also use MASTER VOLUME on the receiver.
- The adjusted value are shown on the display during adjustment.

### To turn off the test tone

Repeat steps 1 to 5 above to select “T. TONE N”. You can also press any input buttons.

### When a test tone is not output from the speakers

- The speaker cords may not be connected securely.
- The speaker cords may have the short-circuit problem.

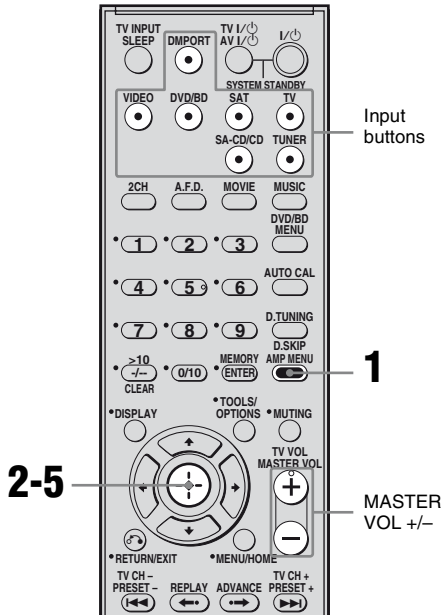

## 1 Press AMP MENU.

“1-LEVEL” appears on the display.

## 2 Press $\oplus$ or $\rightarrow$ to enter the menu.

## 3 Press $\uparrow/\downarrow$ repeatedly to select “T. TONE”.

## 4 Press $\oplus$ or $\rightarrow$ to enter the parameter.



## Selecting a component

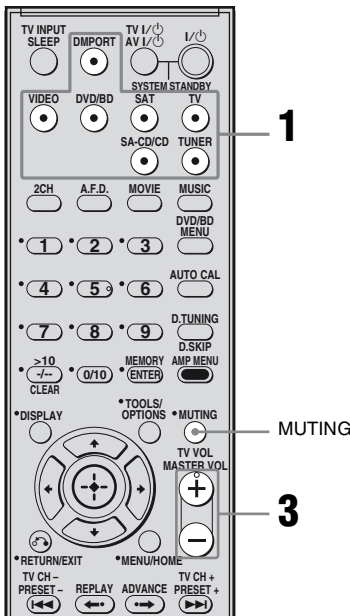

### 1 Press the input button to select a component.

You can also use INPUT SELECTOR on the receiver.

The selected input appears on the display.

| Selected input [Display]                | Components that can be played back   |
|---|--|
| VIDEO<br>[VIDEO/<br>PORTABLE<br>AUDIO]* | MP3 player, etc.,<br>connected to the VIDEO<br>IN/PORTABLE AUDIO<br>IN/AUTO CAL MIC jack |
| DVD/BD<br>[DVD/BD]                      | DVD player, etc.,<br>connected to the DVD/BD<br>jack                                     |
| SAT<br>[SAT]                            | Satellite tuner, set-top box,<br>etc., connected to the SAT<br>jack                      |
| TV<br>[TV]                              | TV, etc., connected to the<br>TV jack  |
| SA-CD/CD<br>[SA-CD/CD]                  | Super Audio CD player,<br>CD player, etc., connected<br>to the SA-CD/CD jack             |
| TUNER<br>[FM or AM band]                | Built-in radio tuner   |
| DMPORT<br>[DMPORT]                      | DIGITAL MEDIA PORT<br>adapter connected to the<br>DMPORT jack                            |

\* "VIDEO/PORTABLE AUDIO" scrolls across the display, then "VIDEO" appears.

### 2 Turn on the component and start playback.

### 3 Press MASTER VOL +/- to adjust the volume.

You can also use MASTER VOLUME on the receiver.

### To activate the muting function

Press MUTING.

The muting function will be canceled when you do the following.

- Press MUTING again.
- Increase the volume.
- Turn off the receiver.

### To avoid damaging your speakers

Before you turn off the receiver, be sure to turn down the volume level.

# Listening/Watching a component

## Listening to a Super Audio CD/CD

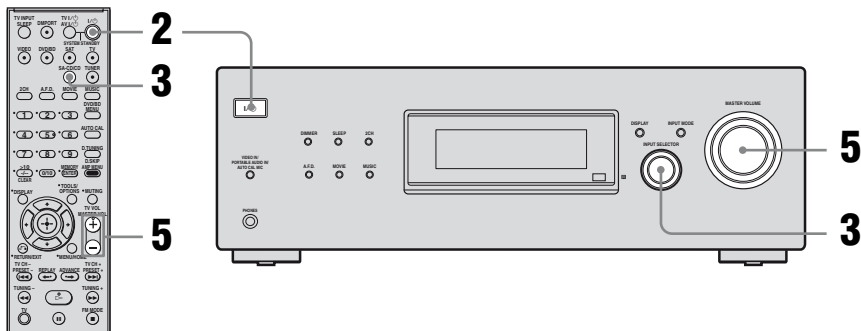

### Notes

- The operation is described for a Sony Super Audio CD player.
- Refer to the operating instructions supplied with the Super Audio CD player or CD player.

### Tips

- You can select the sound field to suit the music. Refer to page 38 for details.  
Recommended sound fields:  
Classical: HALL  
Jazz: JAZZ  
Live concert: CONCERT
- You can listen to the sound that was recorded in the 2 channel format from all speakers (multi channel). Refer to page 37 for details.

**1** Turn on the Super Audio CD player or CD player, then place the disc on the tray.

**2** Turn on the receiver.

**3** Press SA-CD/CD.

You can also use INPUT SELECTOR on the receiver to select “SA-CD/CD”.

**4** Play back the disc.

**5** Adjust to a suitable volume.

**6** After you have finished listening to the Super Audio CD/CD, eject the disc and turn off the receiver and Super Audio CD player or CD player.

## Watching a DVD/Blu-ray disc

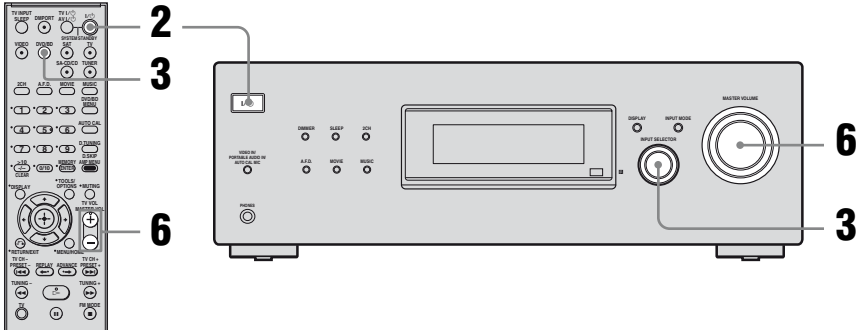

### Notes

- Refer to the operating instructions supplied with the TV and DVD player or Blu-ray disc player.
- Check the following if you cannot listen to multi channel sound.
  - Be sure this receiver is connected to the DVD player or Blu-ray disc player via a digital connection.
  - Be sure the digital audio output of the DVD player or Blu-ray disc player is set up properly.

### Tips

- Select the audio format of the disc to be played, if necessary.
  - You can select the sound field to suit the movie or music. Refer to page 38 for details.
- Recommended sound fields:  
Movie: C.ST.EX  
Music: CONCERT

**1 Turn on the TV and DVD player or Blu-ray disc player.**

**2 Turn on the receiver.**

**3 Press DVD/BD.**

You can also use INPUT SELECTOR on this receiver to select “DVD/BD”.

Be sure to change the factory setting of the DVD/BD input button on the remote so that you can use the button to control your DVD player or Blu-ray disc player. For details, see “Changing button assignments” (page 50).

**4 Switch the input of the TV so that an image of the DVD or Blu-ray disc is displayed.**

If no image is displayed on the TV screen, make sure that the video output of the DVD player or Blu-ray disc player is connected to the TV.

**5 Play back the disc.**

**6 Adjust to a suitable volume.**

**7 After you have finished watching the DVD or Blu-ray disc, eject the disc and turn off the receiver, TV and DVD player or Blu-ray disc player.**

## Amplifier Operations

### Navigating through menus

By using the amplifier menus, you can make various adjustments to customize the receiver.

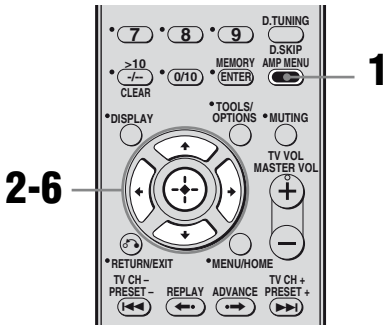

### To return to the previous display

Press ←.

### To exit the menu

Press AMP MENU.

### Note

Some parameters and settings may appear dimmed on the display. This means that they are either unavailable or fixed and unchangeable.

- 1 Press AMP MENU.**  
“1-LEVEL” appears on the display.
- 2 Press ↑/↓ repeatedly to select the menu you want.**
- 3 Press ⊕ or → to enter the menu.**
- 4 Press ↑/↓ repeatedly to select the parameter you want to adjust.**
- 5 Press ⊕ or → to enter the parameter.**
- 6 Press ↑/↓ repeatedly to select the setting you want.**  
The setting is entered automatically.

## Overview of the menus

The following options are available in each menu. For details on navigating through menus, see page 28.

| Menu<br>[Display]               | Parameters<br>[Display]                  | Settings   | Initial<br>setting |
|---------------------------------|--|--|--------------------|
| LEVEL<br>[1-LEVEL]<br>(page 31) | Test tone* [T. TONE]                     | T. TONE N, T. TONE Y                                       | T. TONE N          |
|                                 | Front speaker balance*<br>[FRT BAL]      | BAL. L +1 to BAL. L +8, BALANCE,<br>BAL. R +1 to BAL. R +8 | BALANCE            |
|                                 | Center speaker level<br>[CNT LVL]        | CNT -10 dB to CNT +10 dB<br>(1 dB step)                    | CNT 0 dB           |
|                                 | Surround left speaker level<br>[SL LVL]  | SUR L -10 dB to SUR L +10 dB<br>(1 dB step)                | SUR L 0 dB         |
|                                 | Surround right speaker level<br>[SR LVL] | SUR R -10 dB to SUR R +10 dB<br>(1 dB step)                | SUR R 0 dB         |
|                                 | Subwoofer level<br>[SW LVL]              | SW -10 dB to SW +10 dB<br>(1 dB step)                      | SW 0 dB            |
|                                 | Dynamic range compressor*<br>[D. RANGE]  | COMP. OFF, COMP. STD,<br>COMP. MAX                         | COMP. OFF          |
| TONE<br>[2-TONE]<br>(page 32)   | Front speaker bass level<br>[BASS LVL]   | BASS -6 dB to BASS +6 dB<br>(1 dB step)                    | BASS 0 dB          |
|                                 | Front speaker treble level<br>[TRE LVL]  | TRE -6 dB to TRE +6 dB<br>(1 dB step)                      | TRE -4 dB          |
| SUR<br>[3-SUR]<br>(page 32)     | Sound field selection*<br>[S.F. SELECT]  | For details, see “Enjoying Surround<br>Sound” (page 37).   | A.F.D. AUTO        |
|                                 | Effect level*<br>[EFFECT]                | EFCT. MIN, EFCT. STD,<br>EFCT. MAX                         | EFCT. STD          |
| TUNER<br>[4-TUNER]<br>(page 33) | FM station receiving mode*<br>[FM MODE]  | FM AUTO, FM MONO   | FM AUTO            |
|                                 | Naming preset stations*<br>[NAME IN]     | For details, see “Naming preset<br>stations” (page 44).    |                    |

| <b>Menu<br/>[Display]</b>         | <b>Parameters<br/>[Display]</b>                    | <b>Settings</b>                             | <b>Initial<br/>setting</b> |
|-----------------------------------|--|---|----------------------------|
| AUDIO<br>[5-AUDIO]<br>(page 33)   | Digital audio input decoding priority* [DEC. PRI.] | DEC. PCM, DEC. AUTO                         | DEC. AUTO                  |
|                                   | Digital broadcast language selection* [DUAL]       | DUAL M/S, DUAL M, DUAL S, DUAL M+S          | DUAL M                     |
|                                   | Synchronizes audio with video output* [A.V. SYNC.] | A.V.SYNC. N, A.V.SYNC. Y                    | A.V.SYNC. N                |
|                                   | Naming inputs* [NAME IN]                           | For details, see “Naming inputs” (page 48). |                            |
| SYSTEM<br>[6-SYSTEM]<br>(page 34) | Front speakers distance* [FRT DIST.]               | DIST. 1.0 m to DIST. 7.0 m (0.1 m step)     | DIST. 3.0 m                |
|                                   | Center speaker distance* [CNT DIST.]               | DIST. 1.0 m to DIST. 7.0 m (0.1 m step)     | DIST. 3.0 m                |
|                                   | Surround left speaker distance* [SL DIST.]         | DIST. 1.0 m to DIST. 7.0 m (0.1 m step)     | DIST. 3.0 m                |
|                                   | Surround right speaker distance* [SR DIST.]        | DIST. 1.0 m to DIST. 7.0 m (0.1 m step)     | DIST. 3.0 m                |
|                                   | Surround speaker position* [SUR POS.]              | BEHD/HI, BEHD/LO, SIDE/HI, SIDE/LO          | SIDE/LO                    |
|                                   | Brightness of the display* [DIMMER]                | 0% dim, 40% dim, 70% dim                    | 0% dim                     |
| A. CAL<br>[7-A. CAL]<br>(page 36) | Auto Calibration* [AUTO CAL]                       | A.CAL NO, A.CAL YES                         | A.CAL NO                   |

\* For details, refer to the page in the parentheses.

## Adjusting the level

### (LEVEL menu)

You can use the LEVEL menu to adjust the balance and level of each speaker. These settings are applied to all sound fields. Select “1-LEVEL” in the amplifier menus. For details on adjusting the parameters, see “Navigating through menus” (page 28) and “Overview of the menus” (page 29).

### LEVEL menu parameters

#### ■ T. TONE (Test tone)

Lets you adjust the speaker levels and balance while listening to the test tone from your listening position. For details, see “7: Adjusting the speaker levels and balance (TEST TONE)” (page 24).

#### ■ FRT BAL (Front speaker balance)

Lets you adjust the balance between front left and right speakers.

#### ■ CNT LVL (Center speaker level)

#### ■ SL LVL (Surround left speaker level)

#### ■ SR LVL (Surround right speaker level)

#### ■ SW LVL (Subwoofer level)

#### ■ D. RANGE (Dynamic range compressor)

Lets you compress the dynamic range of the sound track. This may be useful when you want to watch movies at low volumes late at night. Dynamic range compression is possible with Dolby Digital sources only.

- COMP. OFF  
The dynamic range is not compressed.
- COMP. STD  
The dynamic range is compressed as intended by the recording engineer.
- COMP. MAX  
The dynamic range is compressed dramatically.

#### Tip

Dynamic range compressor lets you compress the dynamic range of the soundtrack based on the dynamic range information included in the Dolby Digital signal. “COMP. STD” is the standard setting, but it only enacts light compression. Therefore, we recommend using the “COMP. MAX” setting. This greatly compresses the dynamic range and lets you view movies late at night at low volumes. Unlike analog limiters, the levels are predetermined and provide a very natural compression.

## Adjusting the tone (TONE menu)

You can use the TONE menu to adjust the tonal quality (bass/treble level) of the front speakers.

Select “2-TONE” in the amplifier menus. For details on adjusting the parameters, see “Navigating through menus” (page 28) and “Overview of the menus” (page 29).

### TONE menu parameters

- **BASS LVL (Front speaker bass level)**
- **TRE LVL (Front speaker treble level)**

## Settings for the surround sound (SUR menu)

You can use the SUR menu to select the sound field you want for your listening pleasure. Select “3-SUR” in the amplifier menus. For details on adjusting the parameters, see “Navigating through menus” (page 28) and “Overview of the menus” (page 29).

### SUR menu parameters

#### ■ **S.F. SELCT (Sound field selection)**

Lets you select the sound field you want. For details, see “Enjoying Surround Sound” (page 37).

#### **Note**

The receiver lets you apply the last selected sound field to an input whenever it is selected (Sound Field Link). For example, if you select “HALL” for the SA-CD/CD input, then change to a different input and then return to SA-CD/CD, “HALL” will automatically be applied again.

#### ■ **EFFECT (Effect level)**

Lets you adjust the “presence” of the surround effect for sound fields selected with the MOVIE or MUSIC buttons and for “HP THEA” sound field.

- **EFCT. MIN**  
The surround effect is minimum.
- **EFCT. STD**  
The surround effect is standard.
- **EFCT. MAX**  
The surround effect is maximum.



## Settings for the tuner

### (TUNER menu)

You can use the TUNER menu to set the FM station receiving mode and to name preset stations.

Select “4-TUNER” in the amplifier menus. For details on adjusting the parameters, see “Navigating through menus” (page 28) and “Overview of the menus” (page 29).

### TUNER menu parameters

#### ■ FM MODE (FM station receiving mode)

- FM AUTO

This receiver will decode the signal as stereo signal when the radio station is broadcast in stereo.

- FM MONO

This receiver will decode the signal as mono signal regardless of the broadcast signal.

#### ■ NAME IN (Naming preset stations)

Lets you set the name of preset stations. For details, see “Naming preset stations” (page 44).

## Settings for the audio

### (AUDIO menu)

You can use the AUDIO menu to make settings for the audio to suit your preference. Select “5-AUDIO” in the amplifier menus. For details on adjusting the parameters, see “Navigating through menus” (page 28) and “Overview of the menus” (page 29).

### AUDIO menu parameters

#### ■ DEC. PRI. (Digital audio input decoding priority)

Lets you specify the input mode for the digital signal input to the DIGITAL IN jacks.

- DEC. PCM

PCM signals are given priority (to prevent interruption when playback starts).

However, when other signals are input, there may be no sound depending on the format.

In this case, set to “DEC. AUTO”.

- DEC. AUTO

Automatically switches the input mode between DTS, Dolby Digital, or PCM.

#### Note

When set to “DEC. AUTO” and the sound from the digital audio jacks (for a CD, etc.) is interrupted when playback starts, set to “DEC. PCM”.

## ■ DUAL (Digital broadcast language selection)

Lets you select the language you want to listen to during digital broadcast. This feature only functions for Dolby Digital sources.

- DUAL M/S (Main/Sub)  
Sound of the main language will be output through the front left speaker and sound of the sub language will be output through the front right speaker simultaneously.
- DUAL M (Main)  
Sound of the main language will be output.
- DUAL S (Sub)  
Sound of the sub language will be output.
- DUAL M+S (Main + Sub)  
Mixed sound of both the main and sub languages will be output.

## ■ A.V. SYNC. (Synchronizes audio with video output)

- A.V.SYNC. N (No) (Delay time: 0 ms)  
The audio output is not delayed.
- A.V.SYNC. Y (Yes) (Delay time: 60 ms)  
The audio output is delayed so that the time gap between the audio output and visual display is minimized.

### Notes

- This parameter is useful when you use a large LCD or plasma monitor or a projector.
- This parameter is valid only when you use a sound field selected with the 2CH or A.F.D. button.
- This parameter is not valid when signals with a sampling frequency of more than 48 kHz are input.

## ■ NAME IN (Naming inputs)

Lets you set the name of inputs. For details, see “Naming inputs” (page 48).

# Settings for the system (SYSTEM menu)

You can use the SYSTEM menu to set the distance of the speakers connected to this system.

Select “6-SYSTEM” in the amplifier menus. For details on adjusting the parameters, see “Navigating through menus” (page 28) and “Overview of the menus” (page 29).

## SYSTEM menu parameters

### ■ FRT DIST. (Front speakers distance)

Lets you set the distance from your listening position to the front speaker (A). If both front speakers are not placed an equal distance from your listening position, set the distance to the closest speaker.

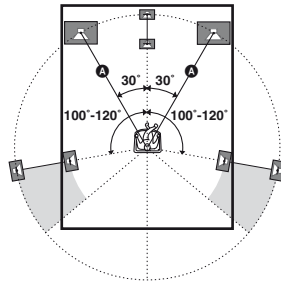

### ■ CNT DIST. (Center speaker distance)

Lets you set the distance from your listening position to the center speaker.

### ■ SL DIST. (Surround left speaker distance)

### ■ SR DIST. (Surround right speaker distance)

Lets you set the distance from your listening position to the surround speaker.

**Tip**

To enjoy better surround sound, the distance between the center speaker and the listening position **[B]** cannot be more than 1.5 meters closer than the one between the listening position and the front speaker **[A]**. Place the speakers so that the difference in the length of **[B]** in the following diagram is no more than 1.5 meters closer than the length of **[A]**. Example: Adjust the distance **[B]** to 4.5 meters or more when the distance **[A]** is 6 meters.

Also, the distance between the surround speakers and the listening position **[C]** cannot be more than 4.5 meters closer than the distance between the listening position and the front speakers **[A]**. Place the speakers so that the difference in the length of **[C]** in the following diagram is no more than 4.5 meters closer than the length of **[A]**. Example: Adjust the distance **[C]** to 1.5 meters or more when the distance **[A]** is 6 meters.

This is important because incorrect speaker placement is not conducive to the enjoyment of surround sound. Please note that placing the speakers closer than the required will cause a delay in the output of the sound from that speaker. In other words, the speaker will sound like it is farther away. Adjusting these parameter while listening to the sound often results in much better surround sound. Give it a try!

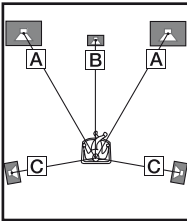

**■ SUR POS. (Surround speaker position)**

Lets you specify the location of your surround speakers for proper implementation of the surround effects in the CINEMA STUDIO EX modes (page 39).

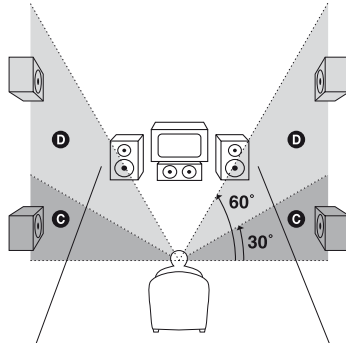
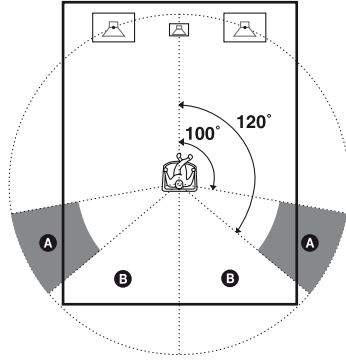

- **BEHD/HI**  
Select if the location of your surround speakers corresponds to sections **B** and **D**.
- **BEHD/LO**  
Select if the location of your surround speakers corresponds to sections **B** and **C**.
- **SIDE/HI**  
Select if the location of your surround speakers corresponds to sections **A** and **D**.
- **SIDE/LO**  
Select if the location of your surround speakers corresponds to sections **A** and **C**.

## Tip

Surround speaker position is designed specifically for implementation of the CINEMA STUDIO EX modes. For other sound fields, speaker position is not so critical.

Those sound fields were designed under the premise that the surround speakers would be located behind the listening position, but presentation remains fairly consistent even with the surround speakers positioned at a rather wide angle. However, if the speakers are pointing toward the listener from the immediate left and right of the listening position, the surround effects become unclear unless set to “SIDE/LO” or “SIDE/HI”.

Nevertheless, each listening environment has many variables, such as wall reflections, and you may obtain better results using “BEHD/HI” if your speakers are located high above the listening position, even if they are located to the immediate left and right.

Therefore, although it may result in a setting contrary to the above explanation, we recommend that you play back multi channel surround encoded software and select the setting that provides a good sense of spaciousness and that best succeeds in forming a cohesive space between the surround sound from the surround speakers and the sound of the front speakers. If you are not sure which sounds best, select “BEHD/LO” or “BEHD/HI” and then use the speaker distance parameter and speaker level adjustments to obtain proper balance.

## ■ DIMMER (Brightness of the display)

Lets you adjust the brightness in 3 steps.

# Calibrating the appropriate settings automatically

## (A. CAL menu)

For details, see “6: Calibrating the appropriate settings automatically (AUTO CALIBRATION)” (page 20).

# Enjoying Dolby Digital and DTS surround sound (AUTO FORMAT DIRECT)

The Auto Format Direct (A.F.D.) mode allows you to listen to higher fidelity sound and select the decoding mode for listening to a 2 channel stereo sound as multi channel sound.

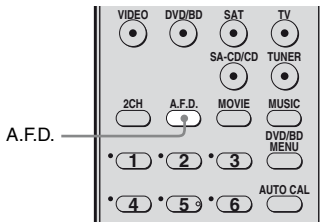

**Press A.F.D. repeatedly to select the sound field you want.**

For details, see “Types of A.F.D. mode” (page 37).

### Types of A.F.D. mode

| A.F.D. mode [Display]        | Multi channel audio after decoding | Effect  |
|------------------------------|------------------------------------|---|
| A.F.D. AUTO [A.F.D. AUTO]    | (Detecting automatically)          | Presents the sound as it was recorded/encoded without adding any surround effects. However, this receiver will generate a low frequency signal for output to the subwoofer when there is no LFE signals.                |
| PRO LOGIC [DOLBY PL]         | 4 channel                          | Performs Dolby Pro Logic decoding. The source recorded in 2 channel format is decoded into 4.1 channel.   |
| PRO LOGIC II MOVIE [PLII MV] | 5 channel                          | Performs Dolby Pro Logic II Movie mode decoding. This setting is ideal for movies encoded in Dolby Surround. In addition, this mode can reproduce sound in 5.1 channel for watching videos of overdubbed or old movies. |
| PRO LOGIC II MUSIC [PLII MS] | 5 channel                          | Performs Dolby Pro Logic II Music mode decoding. This setting is ideal for normal stereo sources such as CDs.   |
| MULTI STEREO [MULTI ST.]     | (Multi Stereo)                     | Outputs 2 channel left/right signals from all speakers.   |

# Selecting a pre-programmed sound field

You can take advantage of surround sound simply by selecting one of the receiver's pre-programmed sound fields. They bring the exciting and powerful sound of movie theaters and concert halls into your home.

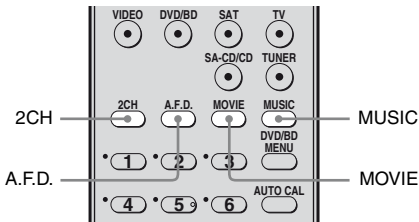

**Press MOVIE repeatedly to select a sound field for movies or press MUSIC repeatedly to select a sound field for music.**

For details, see “Types of sound field available” (page 39).

## Types of sound field available

| Sound field for | Sound field [Display]                        | Effect   |
|-----------------|--|--|
| Movie           | CINEMA STUDIO EX A<br><b>DCS</b> [C.ST.EX A] | Reproduces the sound characteristics of the Sony Pictures Entertainment "Cary Grant Theater" cinema production studio. This is a standard mode, great for watching almost any type of movie.   |
|                 | CINEMA STUDIO EX B<br><b>DCS</b> [C.ST.EX B] | Reproduces the sound characteristics of the Sony Pictures Entertainment "Kim Novak Theater" cinema production studio. This mode is ideal for watching science-fiction or action movies with lots of sound effects.   |
|                 | CINEMA STUDIO EX C<br><b>DCS</b> [C.ST.EX C] | Reproduces the sound characteristics of the Sony Pictures Entertainment scoring stage. This mode is ideal for watching musicals or films where orchestra music is featured in the soundtrack.  |
| Music           | PORTABLE AUDIO ENHANCER<br>[PORTABLE]        | Reproduces a clear enhanced sound image from your portable audio device. This mode is ideal for MP3 and other compressed music.  |
|                 | HALL [HALL]                                  | Reproduces the acoustics of a classical concert hall.  |
|                 | JAZZ CLUB [JAZZ]                             | Reproduces the acoustics of a jazz club.   |
|                 | LIVE CONCERT<br>[CONCERT]                    | Reproduces the acoustics of a 300-seat live house.   |
| Headphone*      | HEADPHONE 2CH<br>[HP 2CH]                    | This mode is selected automatically if you use headphones when 2CH STEREO mode (page 40)/A.F.D. mode (page 37) is selected. Standard 2 channel stereo sources completely bypass the sound field processing and multi channel surround formats are downmixed to 2 channels. |
|                 | HEADPHONE THEATER<br><b>DCS</b> [HP THEA]    | This mode is selected automatically if you use headphones when sound field for movie/music is selected. It allows you to experience a theater-like environment while listening through a pair of headphones.   |

\* You can only select this sound field if the headphones are connected to the receiver.

### Notes

- The effects provided by the virtual speakers may cause increased noise in the playback signal.
- When listening with sound fields that employ the virtual speakers, you will not be able to hear any sound coming directly from the surround speakers.
- This function does not work for signals with a sampling frequency of more than 48 kHz.

### Tips

- You can identify the encoding format of DVD software, etc., by looking at the logo on the package.
- Sound fields with **DCS** mark use DCS technology. See "Glossary" (page 51).

### To turn off the surround effect for movie/music

Press 2CH to select "2CH ST." or press A.F.D. repeatedly to select "A.F.D. AUTO".

## Using only the front speakers and subwoofer (2CH STEREO)

In this mode, the receiver outputs the sound from the front left/right speakers and the subwoofer.

When multi channel surround formats are input, the signals are downmixed to 2 channel with bass frequencies being output from the subwoofer.

When standard 2 channel stereo sources are input, the receiver's bass redirection circuitry will be activated. The front channel bass frequencies will be output from the subwoofer.

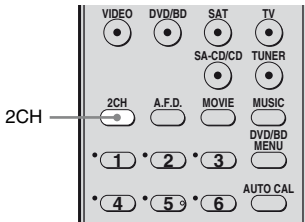

**Press 2CH.**

## Resetting sound fields to the initial settings

Be sure to use the buttons on the receiver for this operation.

**1,2**

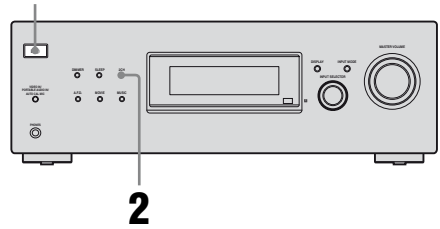

**1** Press I/O to turn off the receiver.

**2** While holding down 2CH, press I/O.

“S.F. CLR.” appears on the display and all sound fields are reset to their initial setting.



## Tuner Operations

# Listening to FM/AM radio

You can listen to FM and AM broadcasts through the built-in tuner. Before operation, make sure you have connected the FM and AM antennas to the receiver (page 18).

### Tip

The tuning scale for direct tuning differs depending on the area code as shown in the following table. For details on area codes, see page 2.

| Area code | FM     | AM      |
|-----------|--------|---------|
| E51       | 50 kHz | 10 kHz* |
| AR2       | 50 kHz | 10 kHz  |

\* The AM tuning scale can be changed (page 42).

## Automatic tuning

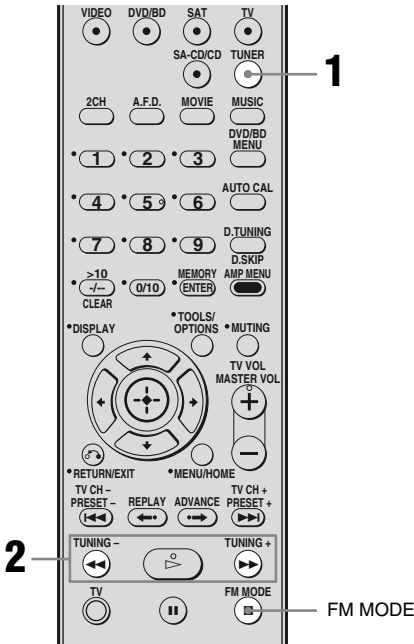

## 1 Press TUNER repeatedly to select the FM or AM band.

You can also use INPUT SELECTOR on the receiver.

## 2 Press TUNING + or TUNING -.

Press TUNING + to scan from low to high; press TUNING - to scan from high to low.

The receiver stops scanning whenever a station is received.

## In case of poor FM stereo reception

If the FM stereo reception is poor and “ST” flashes on the display, select monaural audio so that the sound will be less distorted.

Press FM MODE repeatedly until the “MONO” indicator lights up on the display.

To return to stereo mode, press FM MODE repeatedly until the “MONO” indicator on the display lights off.

## Direct tuning

You can enter the frequency of a station directly by using the numeric buttons.

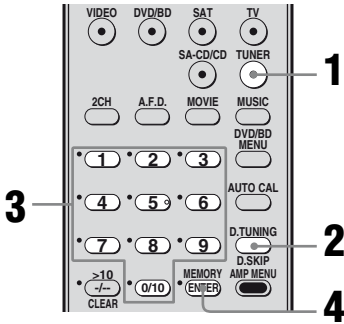

### 1 Press TUNER repeatedly to select the FM or AM band.

You can also use INPUT SELECTOR on the receiver.

### 2 Press D.TUNING.

### 3 Press the numeric buttons to enter the frequency.

Example 1: FM 102.50 MHz

Select 1 → 0 → 2 → 5 → 0

Example 2: AM 1,350 kHz

Select 1 → 3 → 5 → 0

#### Tip

If you have tuned in an AM station, adjust the direction of the AM loop antenna for optimum reception.

### 4 Press ENTER.

## If you cannot tune in a station

Make sure you have entered the right frequency. If not, repeat steps 2 to 4. If you still cannot tune in a station, the frequency is not used in your area.

## Changing the AM tuning scale

### (Models of area code E51 only)

You can change the AM tuning scale to either 9 kHz or 10 kHz using the buttons on the receiver.

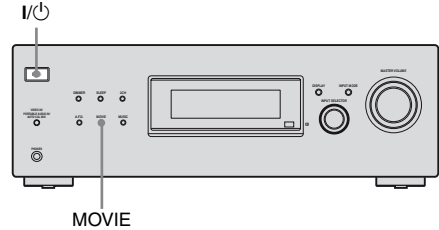

### 1 Press I/POWER to turn off the receiver.

### 2 While holding down MOVIE, press I/POWER.

### 3 Change the current AM tuning scale to 9 kHz (or 10 kHz).

To reset the scale to 10 kHz (or 9 kHz), repeat the procedure above.

#### Note

All preset stations will be erased when you change the tuning scale.

# Presetting radio stations

You can preset up to 30 FM stations and 30 AM stations. Then you can easily tune in the stations you often listen to.

## Presetting radio stations

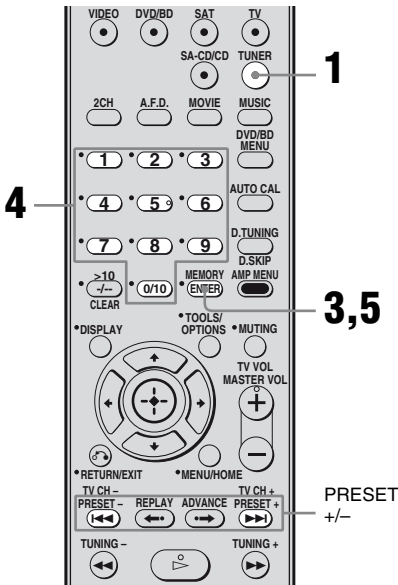

### 4 Press the numeric buttons to select a preset number.

You can also press PRESET + or PRESET – repeatedly to select a preset number.

If “MEMORY” goes out before you select the preset number, start again from step 3.

### 5 Press ENTER.

The station is stored as the selected preset number.

If “MEMORY” goes out before you press ENTER, start again from step 3.

### 6 Repeat steps 1 to 5 to preset another station.

### 1 Press TUNER repeatedly to select the FM or AM band.

You can also use INPUT SELECTOR on the receiver.

### 2 Tune in the station that you want to preset using Automatic Tuning (page 41) or Direct Tuning (page 42).

Switch the FM reception mode, if necessary (page 41).

### 3 Press MEMORY.

“MEMORY” lights up for a few seconds. Perform steps 4 and 5 before “MEMORY” goes out.

## Tuning to preset stations

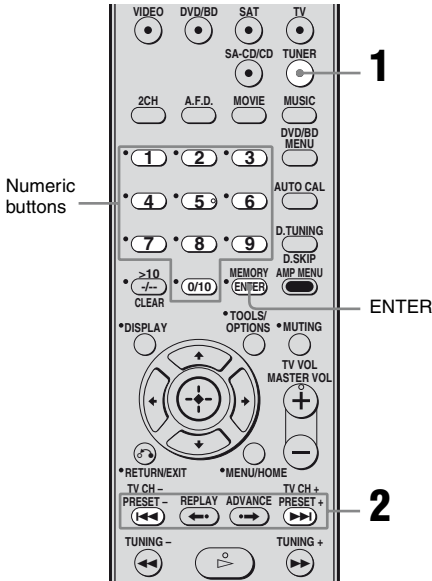

### 1 Press TUNER repeatedly to select the FM or AM band.

You can also use INPUT SELECTOR on the receiver.

### 2 Press PRESET + or PRESET – repeatedly to select the preset station you want.

Each time you press the button, you can select a preset station as follows:

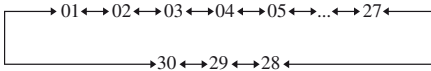

You can also press the numeric buttons to select the preset station you want. Then, press ENTER to enter the selection.

## Naming preset stations

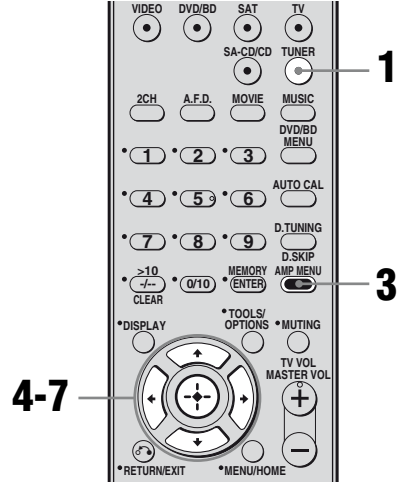

### 1 Press TUNER repeatedly to select the FM or AM band.

You can also use INPUT SELECTOR on the receiver.

### 2 Tune in the preset station you want to create an index name for (page 44).

### 3 Press AMP MENU.

“1-LEVEL” appears on the display.

### 4 Press ↑/↓ repeatedly to select “4-TUNER”.

### 5 Press ⊕ or → to enter the menu.

### 6 Press ↑/↓ repeatedly to select “NAME IN”.

### 7 Press ⊕ or → to enter the parameter.

The cursor flashes and you can select a character. Follow the procedure given in “To create an index name” below.

## Other Operations

### Switching between digital and analog audio (INPUT MODE)

You can select the audio input mode setting when you connect components to both digital and analog audio input jacks on the receiver.

#### 1 Turn INPUT SELECTOR on the receiver to select the input.

You can also use the input buttons on the remote.

#### 2 Press INPUT MODE repeatedly on the receiver to select the audio input mode.

The selected audio input mode appears on the display.

### Audio input modes

#### ■ AUTO

Gives priority to digital audio signals when there are both digital and analog connections. If there are no digital audio signals, analog audio signals are selected.

#### ■ ANALOG

Specifies the analog audio signals input to the AUDIO IN (L/R) jacks.

#### Note

Some audio input modes may not be set up depending on the input.

### To create an index name

- 1 Use **▲/▼/◀/▶** to create an index name.  
Press **▲/▼** to select a character, then press **◀/▶** to move the cursor to the next position.

#### If you made a mistake

Press **◀/▶** until the character you want to change flashes, then press **▲/▼** to select the correct character.

#### Tips

- You can select the character type as follows by pressing **▲/▼**.  
Alphabet (upper case) → Numbers → Symbols
  - To enter a blank space, press **▶** without selecting a character.
- 2 Press **⊕** to enter the name.  
The entered name is registered.

# Enjoying the DIGITAL MEDIA PORT (DMPORT)

The DIGITAL MEDIA PORT (DMPORT) allows you to enjoy sound from a network system such as a portable audio source or computer.

When you connect a DIGITAL MEDIA PORT adapter (not supplied), you can enjoy sound from the connected component on the receiver.

For details, see the operating instructions supplied with the DIGITAL MEDIA PORT adapter.

## Notes

- Do not connect an adapter other than the DIGITAL MEDIA PORT adapter.
- Before connecting the cords, be sure to disconnect the AC power cord (mains lead).
- Do not connect or disconnect the DIGITAL MEDIA PORT adapter while the receiver is turned on.
- Depending on the DIGITAL MEDIA PORT adapter, video output may not be possible.
- The DIGITAL MEDIA PORT adapters are available for purchase depending on the area.

## Connecting the DIGITAL MEDIA PORT adapter

You can listen to the sound from the component connected through the DIGITAL MEDIA PORT adapter to the DMPORT jack on the receiver.

You can also view the images on the TV screen by connecting the video output of the DIGITAL MEDIA PORT adapter to the video input of the TV.

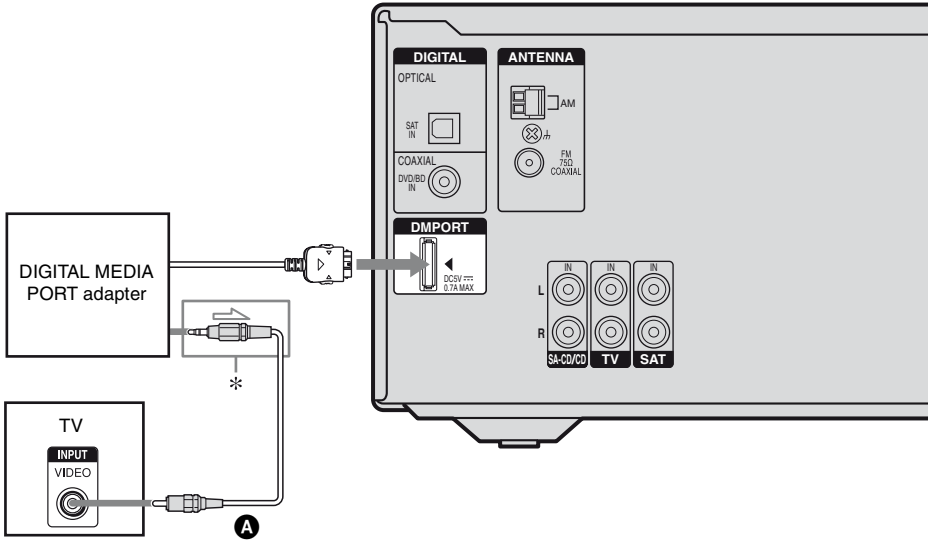

\* The type of connector varies depending on the DIGITAL MEDIA PORT adapter.  
For details, see the operating instructions supplied with the DIGITAL MEDIA PORT adapter.

**A** Video cord (not supplied)

## To detach the DIGITAL MEDIA PORT adapter from DMPORT jack

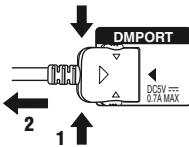

Press and hold both sides of the connector and then pull out the connector.

## Notes

- When connecting the DIGITAL MEDIA PORT adapter, be sure the connector is inserted with the arrow mark facing towards the arrow mark on the DMPORT jack.
- Be sure to make DMPORT connections firmly, insert the connector straight in.
- As the connector of the DIGITAL MEDIA PORT adapter is fragile, be sure to handle with care when placing or moving the receiver.

## Listening/watching a connected component through DMPORT connection

### 1 Press DMPORT.

You can also use the INPUT SELECTOR on the receiver to select “DMPORT”.

### 2 Start playback of the connected component.

The sound is played back on the receiver and the image appears on the TV.

For details, refer the operating instructions supplied with the DIGITAL MEDIA PORT adapter.

#### Notes

- Depending on the type of DIGITAL MEDIA PORT adapter, you can operate the connected component by using the remote. For details on remote button operation, see page 8.
- Be sure you have made the video connection from DIGITAL MEDIA PORT adapter to the TV (page 47).
- Depending on the DIGITAL MEDIA PORT adapter, video output may not be possible.

#### Tip

When listening to MP3 or other compressed music using a portable audio source, you can enhance the sound. Press MUSIC repeatedly to select “PORTABLE” (page 38).

## Naming inputs

You can enter a name of up to 8 characters for inputs and display it on the receiver’s display. This is convenient for labeling the jacks with the names of the connected components.

### 1 Press the input button to select the input you want to create an index name for.

You can also use INPUT SELECTOR on the receiver.

### 2 Press AMP MENU.

“1-LEVEL” appears on the display.

### 3 Press $\uparrow/\downarrow$ repeatedly to select “5-AUDIO”.

### 4 Press $\oplus$ or $\rightarrow$ to enter the menu.

### 5 Press $\uparrow/\downarrow$ to select “NAME IN”.

### 6 Press $\oplus$ or $\rightarrow$ to enter the parameter.

The cursor flashes and you can select a character. Follow the procedure given in “To create an index name” (page 45).



## Changing the display

You can check the sound field, etc., by changing the information on the display. Be sure to use the buttons on the receiver for this operation.

### Press DISPLAY repeatedly.

Each time you press the button, the display changes cyclically as follows.

### All inputs except the FM and AM band

Index name of the input\* → Selected input → Sound field currently applied

### FM and AM band

Preset station name\* → Frequency → Sound field currently applied

\* Index name appears only when you have assigned one to the input or preset station (page 44, 48). Index name does not appear when only blank spaces have been entered, or it is the same as the input name.

### Note

Character or marks may not be displayed for some languages.

## Using the Sleep Timer

You can set the receiver to turn off automatically at a specified time.

### Press SLEEP repeatedly while the power is on.

Each time you press the button, the display changes cyclically as follows:

2-00-00 → 1-30-00 → 1-00-00 → 0-30-00  
→ OFF

When sleep timer is activated, the display dims.

### Note

If you press any buttons on the remote or receiver after the display dims, the display brightens up. After a while, the display dims again if no button is pressed.

### Tip

To check the remaining time before the receiver turns off, press SLEEP. The remaining time appears on the display. If you press SLEEP again, the sleep timer will be canceled.

### Changing button assignments

You can change the factory settings of the input buttons to suit the components in your system. For example, if you connect a DVD player to the SAT jacks on the receiver, you can set the SAT button on this remote to control the DVD player.

#### 1 Hold down the input button of which you want to change the assignment.

Example: Hold down SAT.

#### 2 Referring to the table below, press the corresponding button for the category you want.

Example: Press 3.

Now you can use the SAT button to control the DVD player.

### Categories and the corresponding buttons

| Categories  | Press            |
|---|------------------|
| VCR (command mode VTR 3) <sup>a)</sup>                    | 1                |
| VCR (command mode VTR 2) <sup>a)</sup>                    | 2                |
| DVD player/DVD recorder (command mode DVD1) <sup>b)</sup> | 3                |
| DVD recorder (command mode DVD3) <sup>b)</sup>            | 4                |
| CD player   | 5                |
| Euro Digital Satellite Receiver                           | 6                |
| DVR (Digital CATV terminal)                               | 7                |
| DSS (Digital Satellite Receiver)                          | 8                |
| Blu-ray disc player (command mode BD1) <sup>c)</sup>      | 9                |
| Blu-ray disc recorder (command mode BD3) <sup>c)</sup>    | 0/10             |
| TV  | -/--             |
| Not assigned  | ENTER/<br>MEMORY |

<sup>a)</sup> Sony VCRs are operated with a VTR 2 or VTR 3 setting which corresponds to 8 mm and VHS respectively.

<sup>b)</sup> Sony DVD recorders are operated with a DVD1 or DVD3 setting. For details, refer to the operating instructions supplied with the DVD recorders.

<sup>c)</sup> For details on the BD1 or BD3 setting, refer to operating instructions supplied with the Blu-ray disc player or Blu-ray disc recorder.

### To clear all remote button assignments

Press I/⏪, DMPORT and MASTER VOL – at the same time.

The remote is reset to its factory settings.

# Glossary

### ■ Cinema Studio EX

A surround sound mode that can be regarded as the compilation of Digital Cinema Sound technology, delivers the sound of a dubbing theater using three technologies: “Virtual Multi Dimensions”, “Screen Depth Matching”, and “Cinema Studio Reverberation”.

“Virtual Multi Dimensions”, the virtual speaker technology, creates a virtual multi-surround environment with actual speakers up to 7.1 channels, and brings the surround sound experience of a theater with the latest facilities into your home.

“Screen Depth Matching” reproduces treble attenuation, fullness, and depth of sound usually created in a theater using sound emission from behind the screen. This is then added to the front and center channels.

“Cinema Studio Reverberation” reproduces the sound characteristics of state-of-the-art dubbing theaters and recording studios, including Sony Pictures Entertainment’s dubbing studios. There are three modes, A/B/C, available according to the studio type.

### ■ Digital Cinema Sound (DCS)

A unique sound reproduction technology for home theater developed by Sony, in cooperation with Sony Pictures Entertainment, for enjoying the exciting and powerful sound of movie theaters at home. With this “Digital Cinema Sound” developed by integrating a DSP (Digital Signal Processor) and measured data, the ideal sound field intended by filmmakers can be experienced at home.

### ■ Dolby Digital

Digital audio encoding/decoding technology developed by Dolby Laboratories, Inc. It consists of front (left/right), center, surround (left/right) and subwoofer channels. It is a designated audio standard for DVD video and also known as 5.1 channel surround. Since surround information is recorded and reproduced in stereo, more realistic sound with fuller presence is delivered than with Dolby surround.

### ■ Dolby Pro Logic II

This technology converts 2 channel stereo recorded audio into 5.1 channel for playback. There is a MOVIE mode for movies and MUSIC mode for stereo sources such as music. Old movies encoded in the traditional stereo format can be enhanced with 5.1 channel surround sound.

### ■ Dolby Surround (Dolby Pro Logic)

Audio processing technology developed by Dolby Laboratories, Inc. Center and mono surround information is matrixed into two stereo channels. When reproduced, audio is decoded and output in 4 channel surround sound. This is the most common audio processing method for DVD video.

### ■ DTS Digital Surround

Digital audio encoding/decoding technology for theaters developed by DTS, Inc. It compresses audio less than Dolby Digital, delivering a higher quality sound reproduction.

## ■ PCM (Pulse Code Modulation)

A method of converting analog audio to digital audio for easy enjoyment of digital sound.

## ■ Sampling frequency

To convert analog audio to digital, analog data should be quantified. This process is called sampling, and the number of times per second the analog data is quantified is called the sampling frequency. A standard music CD stores data quantified at 44,100 times per second, which is expressed as a sampling frequency of 44.1 kHz. Generally speaking, a higher sampling frequency means better sound quality.

# Precautions

## On safety

Should any solid object or liquid fall into the cabinet, unplug the receiver and have it checked by qualified personnel before operating it any further.

## On power sources

- Before operating the receiver, check that the operating voltage is identical with your local power supply.  
The operating voltage is indicated on the nameplate on the back of the receiver.
- The unit is not disconnected from the AC power source (mains) as long as it is connected to the wall outlet, even if the unit itself has been turned off.
- If you are not going to use the receiver for a long time, be sure to disconnect the receiver from the wall outlet. To disconnect the AC power cord, grasp the plug itself; never pull the cord.
- The AC power cord must be changed only at a qualified service shop.

## On heat buildup

Although the receiver heats up during operation, this is not a malfunction. If you continuously use this receiver at a large volume, the cabinet temperature of the top, side and bottom rises considerably. To avoid burning yourself, do not touch the cabinet.

## On placement

- Place the receiver in a location with adequate ventilation to prevent heat buildup and prolong the life of the receiver.
- Do not place the receiver near heat sources, or in a place subject to direct sunlight, excessive dust, or mechanical shock.
- Do not place anything on top of the cabinet that might block the ventilation holes and cause malfunctions.
- Do not place the receiver near equipment such as a TV, VCR, or tape deck. (If the receiver is being used in combination with a TV, VCR, or tape deck, and is placed too close to that equipment, noise may result, and picture quality may suffer. This is especially likely when using an indoor antenna. Therefore, we recommend using an outdoor antenna.)
- Use caution when placing the receiver or speakers on surfaces that have been specially treated (with wax, oil, polish, etc.) as staining or discoloration of the surface may result.

## On operation

Before connecting other components, be sure to turn off and unplug the receiver.

## If you encounter color irregularity on a nearby TV screen

The front speakers, center speaker and the subwoofer are magnetically shielded to allow it to be installed near a TV set. However, color irregularities may still be observed on certain types of TV sets.

As the surround speakers are not magnetically shielded, we recommend that you place the surround speakers slightly further away from the TV set (page 11).

## If color irregularity is observed...

Turn off the TV set, then turn it on again after 15 to 30 minutes.

## If color irregularity is observed again...

Place the speaker further away from the TV set.

## If howling occurs

Reposition the speakers or turn down the volume on the receiver.

## On cleaning

Clean the cabinet, panel, and controls with a soft cloth slightly moistened with a mild detergent solution. Do not use any type of abrasive pad, scouring powder, or solvent, such as alcohol or benzine.

If you have any questions or problems concerning your receiver, please consult your nearest Sony dealer.

---

# Troubleshooting

If you experience any of the following difficulties while using the receiver, use this troubleshooting guide to help you remedy the problem.

## Audio

---

### **There is no sound, no matter which component is selected, or only a very low-level sound is heard.**

- Check that the speakers and components are connected correctly and securely.
- Check that both the receiver and all components are turned on.
- Check that MASTER VOLUME is not set to “VOL MIN”.
- Check that headphones are not connected.
- Press MUTING to cancel the muting function.
- Check that you have selected the correct component with the input buttons (page 25).
- The protective device on the receiver has been activated. Turn off the receiver, eliminate the short-circuit problem, and turn on the power again.

---

### **There is no sound from a specific component.**

- Check that the component is connected correctly to the audio input jacks for that component.
- Check that the cord(s) used for the connection is (are) fully inserted into the jacks on both the receiver and the component.
- Check that you have selected the correct component with the input buttons (page 25).

---

### **There is no sound from one of the front speakers.**

- Connect a pair of headphones to the PHONES jack to verify that sound is output from the headphones. If only one channel is output from the headphones, the component may not be connected to the receiver correctly. Check that all the cords are fully inserted into the jacks on both the receiver and the component. If both channels are output from the headphones, the front speaker may not be connected to the receiver correctly. Check the connection of the front speaker which is not outputting any sound.
- Make sure you have connected to both the L and R jacks of an analog component, and not only to either the L or R jack. Use an audio cord (not supplied).

---

### **There is no sound from digital sources (from OPTICAL input jack).**

- Check that the INPUT MODE is not set to “ANALOG” (page 45).

---

### **The left and right sounds are unbalanced or reversed.**

- Check that the speakers and components are connected correctly and securely.
- Adjust the balance parameters using the LEVEL menu.

---

### **“UNLOCK” appears on the display.**

- Check that your component is connected to the COAXIAL jack. If no signal is input through the COAXIAL jack, “UNLOCK” appears on the display and this is not a malfunction.

---

**There is severe hum or noise.**

- Check that the speakers and components are connected securely.
- Check that the connecting cords are away from a transformer or motor, and at least 3 meters away from a TV set or fluorescent light.
- Move your audio components away from the TV.
- The plugs and jacks are dirty. Wipe them with a cloth slightly moistened with alcohol.

---

**There is severe hum, interrupted noise or distortion from the component connected to the VIDEO IN/PORTABLE AUDIO IN/AUTO CAL MIC jack.**

- Check that the components are connected securely.
- This is not a malfunction and will depend on the connected component.

---

**There is no sound, or only a very low-level sound is heard from the center/surround speakers.**

- Select a CINEMA STUDIO EX mode (page 39).
- Adjust the speaker level (page 24).

---

**There is no sound from the subwoofer.**

- Check that the subwoofer is connected correctly and securely.

---

**The surround effect cannot be obtained.**

- Make sure the sound field function is on (press MOVIE or MUSIC).
- Sound fields do not function for signals with a sampling frequency of more than 48 kHz.

---

**Dolby Digital or DTS multi channel sound is not reproduced.**

- Check that the DVD, etc. you are playing is recorded in Dolby Digital or DTS format.
- When connecting the DVD player, etc. to the digital input jacks of this receiver, check the audio setting (the settings for the audio output) of the connected component.

---

**There is no sound from the component connected to the DIGITAL MEDIA PORT adapter.**

- Adjust the volume of this receiver.
- The DIGITAL MEDIA PORT adapter and/or component is not connected correctly. Turn off the receiver, then reconnect the DIGITAL MEDIA PORT adapter and/or component.
- Check the DIGITAL MEDIA PORT adapter and/or component device to make sure it supports this receiver.

---

**Video**

---

**There is no picture or an unclear picture appears on the TV screen.**

- Make sure you have connected the video output of your video component to the TV.
- Move your audio components away from the TV.
- Depending on the DIGITAL MEDIA PORT adapter, video output may not be possible.

## Tuner

---

### The FM reception is poor.

- Use a 75-ohm coaxial cable (not supplied) to connect the receiver to an outdoor FM antenna as shown below. If you connect the receiver to an outdoor antenna, ground it against lightning. To prevent a gas explosion, do not connect the ground wire to a gas pipe.

Outdoor FM antenna

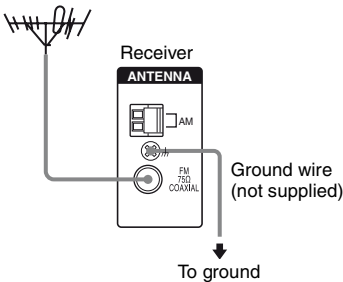

---

### Radio stations cannot be tuned in.

- Check that the antennas are connected securely. Adjust the antennas and connect an external antenna, if necessary.
  - The signal strength of the stations is too weak (when tuning in with automatic tuning). Use direct tuning.
  - Make sure you set the tuning interval correctly (when tuning in AM stations with direct tuning).
  - No stations have been preset or the preset stations have been cleared (when tuning by scanning preset stations). Preset the stations (page 43).
  - Press DISPLAY repeatedly on the receiver so that the frequency appears on the display.
- 

## Remote commander

---

### The remote does not function.

- Point the remote at the remote sensor on the receiver.
  - Remove any obstacles in the path between the remote and the receiver.
  - Replace all the batteries in the remote with new ones, if they are weak.
  - Make sure you select the correct input on the remote.
- 

## Error messages

If there is a malfunction, the display shows a message. You can check the condition of the system by the message. Refer to the following table to solve the problem. If any problem persists, consult your nearest Sony dealer. If an error message appears while you perform Auto Calibration, see “Error and warning codes” (page 22) to solve the problem.

---

## PROTECT

Irregular current is output to the speakers. The receiver will automatically turn off after a few seconds. Check the speaker connection and turn on the power again.

---



## If you are unable to remedy the problem using the troubleshooting guide

Clearing the receiver's memory may remedy the problem (page 19). However, note that all memorized settings will be reset to their initial settings and you will have to readjust all settings on the receiver.

## If the problem persists

Consult your nearest Sony dealer. Note that if service personnel changes some parts during repair, these parts may be retained.

## Reference sections for clearing the receiver's memory

| To clear                | See     |
|-------------------------|---------|
| All memorized settings  | page 19 |
| Customized sound fields | page 40 |

## Specifications

### Amplifier section

Models of area code E51, AR2

Power Output

Stereo mode (rated) (6 ohms 1 kHz, THD 1%)  
85 W + 85 W<sup>1)</sup>  
80 W + 80 W<sup>2)</sup>

Surround mode<sup>3)</sup> (reference)  
(6 ohms 1 kHz, THD 10%)

RMS output

FRONT: 133 W per channel<sup>1)</sup>  
125 W per channel<sup>2)</sup>

CENTER: 133 W<sup>1)</sup>  
125 W<sup>2)</sup>

SURROUND: 133 W per channel<sup>1)</sup>  
125 W per channel<sup>2)</sup>

Surround mode<sup>3)</sup> (reference)  
(6 ohms 100 Hz, THD 10%)

SUBWOOFER: 135 W<sup>1)</sup>  
125 W<sup>2)</sup>

<sup>1)</sup>Measured under the following conditions:

| Area code | Power requirements |
|-----------|--------------------|
| E51       | 240 V AC, 50 Hz    |
| AR2       | 230 V AC, 50 Hz    |

<sup>2)</sup>Measured under the following conditions:

| Area code | Power requirements |
|-----------|--------------------|
| AR2       | 220 V AC, 50 Hz    |

<sup>3)</sup>Reference power output for front, center, surround speakers and subwoofer. Depending on the sound field settings and the source, there may be no sound output.

Inputs

Analog                      Sensitivity: 800 mV/  
50 kohms

Digital (Coaxial)      Impedance: 75 ohms

Tone

Gain levels                ±6 dB, 1 dB step

Reproduction frequency range:

28 – 20,000 Hz

## FM tuner section

|                        |                     |
|------------------------|---------------------|
| Tuning range           | 87.5 - 108.0 MHz    |
| Antenna                | FM wire antenna     |
| Antenna terminals      | 75 ohms, unbalanced |
| Intermediate frequency | 10.7 MHz            |

## AM tuner section

Tuning range

| Area code | Tuning scale       |                    |
|-----------|--------------------|--------------------|
|           | 10 kHz step        | 9 kHz step         |
| E51       | 530 –<br>1,610 kHz | 531 –<br>1,602 kHz |
| AR2       | 530 –<br>1,610 kHz | –                  |

|                        |              |
|------------------------|--------------|
| Antenna                | Loop antenna |
| Intermediate frequency | 450 kHz      |

## General

Power requirements

| Area code | Power requirements            |
|-----------|-------------------------------|
| E51       | 120/220/240 V AC,<br>50/60 Hz |
| AR2       | 220 – 230 V AC, 50/60 Hz      |

|                                   |                |
|-----------------------------------|----------------|
| Power output (DIGITAL MEDIA PORT) |                |
| DC OUT:                           | 5 V, 0.7 A MAX |

Power consumption

| Area code | Power consumption |
|-----------|-------------------|
| E51, AR2  | 220 W             |

|   |       |
|---|-------|
| Power consumption (during standby mode) | 0.3 W |
|---|-------|

|   |  |
|---|--|
| Dimensions (width/height/depth) (Approx.) | 430 × 145 × 306 mm<br>including projecting parts<br>and controls |
|---|--|

|                |        |
|----------------|--------|
| Mass (Approx.) | 7.7 kg |
|----------------|--------|

## Speaker section

- **Front speakers (SS-MSP700)**
- **Center speaker (SS-CNP700)**
- **Surround speakers (SS-SRP700)**

Front/center speakers

Full range, magnetically shielded

Surround speakers Full range

Speaker unit 70 mm, cone type

Enclosure type Close type

Rated Impedance 6 ohms

Dimension (width/height/depth) (Approx.)

Front/surround speakers

92 × 99 × 102 mm

Center speaker 152 × 99 × 102 mm

Mass (Approx.)

Front speakers 0.57 kg

Center speaker 0.69 kg

Surround speakers 0.45 kg

## • Subwoofer (SS-WP700)

Speaker system Magnetically shielded

Speaker unit 200 mm, cone type

Enclosure type Bass reflex

Rated Impedance 6 ohms

Dimensions (width/height/depth) (Approx.)

270 × 330 × 305 mm

including front panel

Mass (Approx.) 4.7 kg

## Supplied speakers

- Front speakers (2)
- Center speaker (1)
- Surround speakers (2)
- Subwoofer (1)

## Supplied accessories

Operating instructions (this manual)

Quick Setup Guide (1)

FM wire antenna (1)

AM loop antenna (1)

Coaxial digital cord (1)

Speaker cords

- Long (2)

- Short (3)

Foot pads

- Speakers (20)

- Subwoofer (4)

Remote commander (RM-AAU025) (1)

R6 (size-AA) batteries (2)

Optimizer microphone (ECM-AC2 or  
ECM-AC2a) (1)

For details on the area code of the component you are using, see page 2.

Design and specifications are subject to change without notice.

Halogenated flame retardants are not used in the certain printed wiring boards.

# Index

## Numerics

2CH STEREO 40  
5.1 channel 11

## A

AUTO CALIBRATION 20  
AUTO FORMAT DIRECT  
(A.F.D.) 37

## B

Blu-ray disc player  
connecting 17  
playback 27

## C

CD player  
connecting 15  
playback 26

## D

Digital Cinema Sound  
(DCS) 51  
DIGITAL MEDIA PORT  
connecting 47  
input 25  
Dolby Digital 51  
DTS 51  
DVD player  
connecting 17  
playback 27

## E

Error messages 56

## I

Initial setup 19  
INPUT MODE 45

## M

Menu  
A. CAL 36  
AUDIO 33  
LEVEL 31  
SUR 32  
SYSTEM 34  
TONE 32  
TUNER 33  
Muting 25

## N

Naming 44, 48

## P

Portable audio  
connecting 15

## R

Remote commander 8

## S

Satellite tuner/Set-top box  
connecting 17  
Selecting  
component 25  
sound field 38  
Sleep Timer 49  
Sound fields  
resetting 40  
selecting 38  
Speakers  
connecting 13  
installing 11  
Super Audio CD player  
connecting 15  
playback 26

## T

TEST TONE 24  
Tuner  
connecting 18  
Tuning  
automatically 41  
directly 42  
to preset stations 44  
TV  
connecting 17



\* 4 1 4 9 2 4 0 1 1 \* (1)