

Compact AV System

Operating Instructions

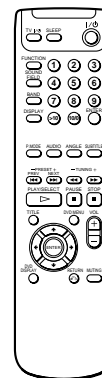
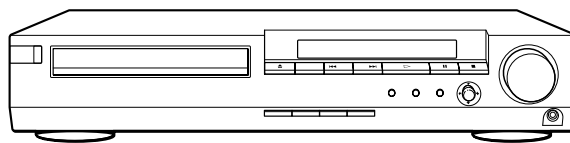

DAV-S300

WARNING

To prevent fire or shock hazard, do not expose the unit to rain or moisture. To avoid electrical shock, do not open the cabinet. Refer servicing to qualified personnel only.

Mains cord must only be changed at qualified service shop.



This appliance is classified as a CLASS 1 LASER product. The CLASS 1 LASER PRODUCT MARKING is located at the rear.

Precautions

Safety

- If anything falls into the cabinet, unplug the unit and have it checked by qualified personnel before operating it any further.
- The unit is not disconnected from the mains as long as it is connected to the mains outlet, even if the unit itself has been turned off.
- Unplug the unit from the wall outlet if you do not intend to use it for an extended period of time. To disconnect the cord, pull it out by the plug, never by the cord.
- Do not use the unit in a car. The operation cannot be guaranteed.

Installing

- Do not install the appliance in a confined space, such as a bookcase or built-in cabinet.
- Allow adequate air circulation to prevent internal heat buildup.
- Do not place the unit on surfaces (rugs, blankets, etc.) or near materials (curtains, draperies) that may block the ventilation slots.
- Do not install the unit near heat sources such as radiators or air ducts, or in a place subject to direct sunlight, excessive dust, mechanical vibration or shock.
- Do not install the unit in an inclined position. It is designed to be operated in a horizontal position only.
- Keep the unit and discs away from equipment with strong magnets, such as microwave ovens or large loudspeakers.
- Do not place heavy objects on the unit.
- If the unit is brought directly from a cold to a warm location, moisture may condense inside the unit and cause damage to the lenses. When you first install the unit, or when you move it from a cold to a warm location, wait for about one hour before operating the unit.

Welcome!

Thank you for purchasing the Sony Compact AV System. Before operating the unit, please read this manual thoroughly and retain it for future reference.

TABLE OF CONTENTS

About This Manual	4
This System Can Play the Following Discs	4
Precautions	6
Notes on Discs	6

Getting Started 7

Unpacking	7
Speaker System Hookup	8
Antenna Hookups	10
TV and Video Component Hookups	11
Connecting the AC Power Cord	12
Selecting the Language for On-Screen Display	13
Speaker Setup	14
Presetting Radio Stations	17

Playing Discs 18

Playing Discs	18
Selecting a Sound Field	20
Customizing Sound Fields	22
Resuming Playback from the Point Where You Stopped the Disc (Resume Play)	23
Using the Menu for Each DVD	24
Playing VIDEO CDs with PBC Functions (PBC Playback)	25
Creating Your Own Program (Program Play)	26
Playing in Random Order (Shuffle Play)	27
Using the Front Panel Display	28

Using Various Functions with the Control Menu 30

Using the Control Menu Display	30
Control Menu Item List	32
Searching for the Title/Chapter/Track/Index/Scene	32
Checking the Playing Time and Remaining Time	33
Selecting a Start Point Using the Time Code	34
Changing the Sounds	35
Displaying the Subtitles	36
Changing the Angles	37
Playing Repeatedly (Repeat Play)	38
Repeating a Specific Portion (A↔B Repeat)	38
Checking the Play Information	40

Settings and Adjustments 41

Using the Setup Display	41
Setup Display Item List	43
Setting the Language for Display and Sound (LANGUAGE SETUP)	44
Settings for Display (SCREEN SETUP)	45
Custom Settings (CUSTOM SETUP)	46
Settings for Sound (AUDIO SETUP)	49
Settings for Speakers (SPEAKER SETUP)	49

Other Operations 51

Controlling the TV with the Supplied Remote	51
Listening to the Radio	53
Naming Preset Stations	54
Using the Sleep Timer	55





Additional Information 56

Troubleshooting	56
Self-diagnosis Function	59
Specifications	60
Glossary	61
Language Code List	63
Index to Parts and Controls	64
Index	68

About This Manual

Conventions

- Instructions in this manual describe the controls on the system. You can also use the controls on the remote if they have the same or similar names as those on the system.
- The icons on the right are used in this manual:

Icon	Meaning
	Indicates that you can use only the remote to do the task.
	Indicates tips and hints for making the task easier.
	Indicates the functions for DVD VIDEOS.
	Indicates the functions for VIDEO CDs.
	Indicates the functions for Audio CDs.

This System Can Play the Following Discs

	DVD VIDEOS		VIDEO CDs		Audio CDs	
Disc logo						
Contents	Audio + Video		Audio + Video		Audio	
Disc size	12 cm	8 cm	12 cm	8 cm	12 cm	8 cm (CD single)
Play time	About 4 h (for single-sided DVD)/ about 8 h (for double-sided DVD)	About 80 min. (for single-sided DVD)/ about 160 min. (for double-sided DVD)	74 min.	20 min.	74 min.	20 min.

“DVD VIDEO” logo is a trademark.

This player switches the color system, PAL or NTSC, according to the connected TV. (For details, see page 11.)

Region code of DVDs you can play on this unit

Your system has a region code printed on the back of the unit and will only play DVDs that are labeled with identical region codes.

DVDs labeled  will be also played on this unit.

If you try to play any other DVD, the message “Playing this disc prohibited by area limits.” will appear on the TV screen.

Depending on the DVD, no region code indication may be labeled even though playing the DVD is prohibited by the area limits.

Region code

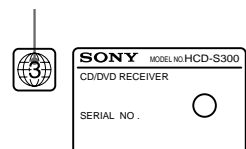

Note on playback operations of DVDs and VIDEO CDs

Some playback operations of DVDs and VIDEO CDs may be intentionally fixed by software producers. Since this system plays DVDs and VIDEO CDs according to the disc contents the software producers designed, some playback features may not be available. Also refer to the instructions supplied with the DVDs or VIDEO CDs.

Terms for discs

- **Title**
The longest sections of a picture or a music piece on a DVD; a movie, etc., for a picture piece on a video software; or an album, etc., for a music piece on an audio software. Each title is assigned a title number enabling you to locate the title you want.
- **Chapter**
Sections of a picture or a music piece that are smaller than titles. A title is composed of several chapters. Each chapter is assigned a chapter number enabling you to locate the chapter you want. Depending on the disc, no chapters may be recorded.
- **Track**
Sections of a picture or a music piece on a VIDEO CD or a CD. Each track is assigned a track number enabling you to locate the track you want.

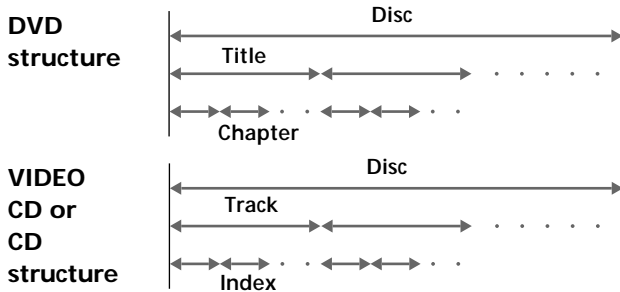

- **Index (CD) / Video Index (VIDEO CD)**
A number that divides a track into sections to easily locate the point you want on a VIDEO CD or a CD. Depending on the disc, no indexes may be recorded.
- **Scene**
On a VIDEO CD with PBC functions, the menu screens, moving pictures and still pictures are divided into sections called "scenes." Each scene is assigned a scene number enabling you to locate the scene you want.

Note on PBC (Playback Control) (VIDEO CDs)

This system conforms to Ver. 1.1 and Ver. 2.0 of VIDEO CD standards. You can enjoy two kinds of playback according to the disc type.

Disc type	You can
VIDEO CDs without PBC functions (Ver. 1.1 discs)	Enjoy video playback (moving pictures) as well as music.
VIDEO CDs with PBC functions (Ver. 2.0 discs)	Play interactive software using menu screens displayed on the TV screen (PBC Playback), in addition to the video playback functions of Ver 1.1 discs. Moreover, you can play high-resolution still pictures, if they are included on the disc.

Discs that the system cannot play

The system cannot play discs other than the ones listed in the table on page 4. CD-R, CD-ROMs including PHOTO CDs, data sections in CD-EXTRAS, DVD-ROMs etc., cannot be played.

This system incorporates Dolby* Digital and Pro Logic Surround and the DTS** Digital Surround System.

* Manufactured under license from Dolby Laboratories.

"Dolby", "AC-3", "Pro Logic" and the double-D symbol $\square\square$ are trademarks of Dolby Laboratories.

Confidential unpublished Works. © 1992-1997 Dolby Laboratories, Inc. All rights reserved.

** Manufactured under license from Digital Theater Systems, Inc. US Pat. No. 5,451,942 and other worldwide patents issued and pending.

"DTS" and "DTS Digital Surround" are trademarks of Digital Theater Systems, Inc. © 1996 Digital Theater Systems, Inc. All rights reserved.

This product incorporates copyright protection technology that is protected by method claims of certain U.S. patents and other intellectual property rights owned by Macrovision Corporation and other rights owners. Use of this copyright protection technology must be authorized by Macrovision Corporation, and is intended for home and other limited viewing uses only unless otherwise authorized by Macrovision Corporation. Reverse engineering or disassembly is prohibited.

Precautions

On safety

- Caution – The use of optical instruments with this product will increase eye hazard.
- Should any solid object or liquid fall into the cabinet, unplug the system and have it checked by qualified personnel before operating it any further.

On power sources

- The system is not disconnected from the AC power source (mains) as long as it is connected to the wall outlet, even if the system itself has been turned off.
- If you are not going to use the system for a long time, be sure to disconnect the system from the wall outlet. To disconnect the AC power cord (mains lead), grasp the plug itself; never pull the cord.
- Should the AC power cord (mains lead) need to be changed, have it done at a qualified service shop only.

On placement

- Place the system in a location with adequate ventilation to prevent heat build-up in the system.
- Do not place the system on a soft surface such as a rug that might block the ventilation holes on the bottom.
- Do not place the system in a location near heat sources, or in a place subject to direct sunlight, excessive dust or mechanical shock.
- Do not place anything on top of the cabinet that might block the ventilation holes and cause malfunctions.

On operation

- If the system is brought directly from a cold to a warm location, or is placed in a very damp room, moisture may condense on the lenses inside the system. Should this occur, the system may not operate properly. In this case, remove the disc and leave the system turned on for about half an hour until the moisture evaporates.

On adjusting volume

- Do not turn up the volume while listening to a portion with very low level inputs or no audio signals. If you do, the speakers may be damaged when a peak level portion is played.

On cleaning

- Clean the cabinet, panel and controls with a soft cloth slightly moistened with a mild detergent solution. Do not use any type of abrasive pad, scouring powder or solvent such as alcohol or benzene.

On your TV's color

- If the speakers should cause the TV screen to have color irregularity, turn off the TV at once then turn it on after 15 to 30 minutes. If color irregularity should persist, place the speakers further away from the set.

If you have any questions or problems concerning your system, please consult your nearest Sony dealer.

IMPORTANT NOTICE

Caution: The enclosed system is capable of holding a still video image or On screen display image on your television screen indefinitely. If you leave the still video image or On screen display image displayed on your TV for an extended period of time you risk permanent damage to your television screen. Projection televisions are very susceptible.

Notes on Discs

On handling discs

- To keep the disc clean, handle the disc by its edge. Do not touch the surface.
- Do not stick paper or tape on the disc. If there is glue (or a similar substance) on the disc, remove the glue completely before using the disc.

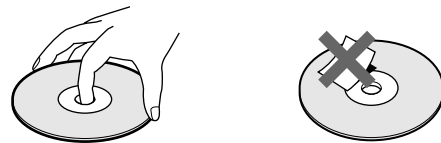

- Do not expose the disc to direct sunlight or heat sources such as hot air ducts, or leave it in a car parked in direct sunlight as there can be considerable rise in temperature inside the car.
- After playing, store the disc in its case.

On cleaning

- Before playing, clean the disc with a cleaning cloth. Wipe the disc from the center out.

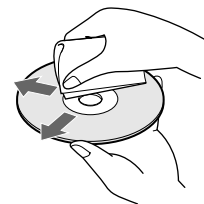

- Do not use solvents such as benzene, thinner, commercially available cleaners or anti-static spray intended for vinyl LPs.

Getting Started

This section describes how to hook up the system to the speakers, a TV monitor with audio/video input jacks and other video component. You cannot connect this system to a TV monitor which does not have a video input connector. Be sure to turn off the power of each component before making the connections.

Unpacking

Check that you have the following items:

- AM loop antenna (1)
- FM wire antenna (1)
- Speakers (5)
- Subwoofer (1)
- Speaker cords (5 m x 4, 15 m x 2)
- Video cord (1)
- Remote commander (remote) RM-SS300 (1)
- R6 (size AA) batteries (2)
- Foot pads (24)
- Speakers - Connection and Installation (card) (1)

Inserting batteries into the remote

You can control the system using the supplied remote. Insert two R6 (size AA) batteries by matching the + and - on the batteries. When using the remote, point it at the remote sensor  on the system.

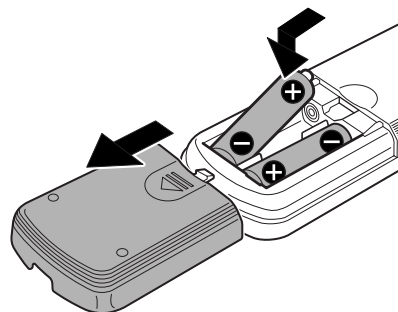

 You can control TVs using the supplied remote
See page 51.

Notes

- Do not leave the remote in an extremely hot or humid place.
- Do not use a new battery with an old one.
- Do not drop any foreign object into the remote casing, particularly when replacing the batteries.
- Do not expose the remote sensor to direct sunlight or lighting apparatuses. Doing so may cause a malfunction.
- If you will not use the remote for an extended period of time, remove the batteries to avoid possible damage from battery leakage and corrosion.

Speaker System Hookup

Connect the supplied speaker system using the supplied speaker cords by matching the colors of the terminals and those of the cords.

To obtain the best possible surround sound, specify the speaker parameters (distance, level, etc.) on page 14.

Required cords

Speaker cords (supplied)

The connector and the color tube of the speaker cords are the same color as the label of the terminals to be connected.

Connect the striped cord with the + terminal tube to the + terminal.

Terminals for connecting the speakers

Connect the	To the
Front speakers	SPEAKER FRONT L (white) and R (red) terminals
Rear speakers	SPEAKER REAR L (blue) and R (yellow) terminals
Center speaker	SPEAKER CENTER (green) terminal
Subwoofer	SPEAKER WOOFER (black) terminal

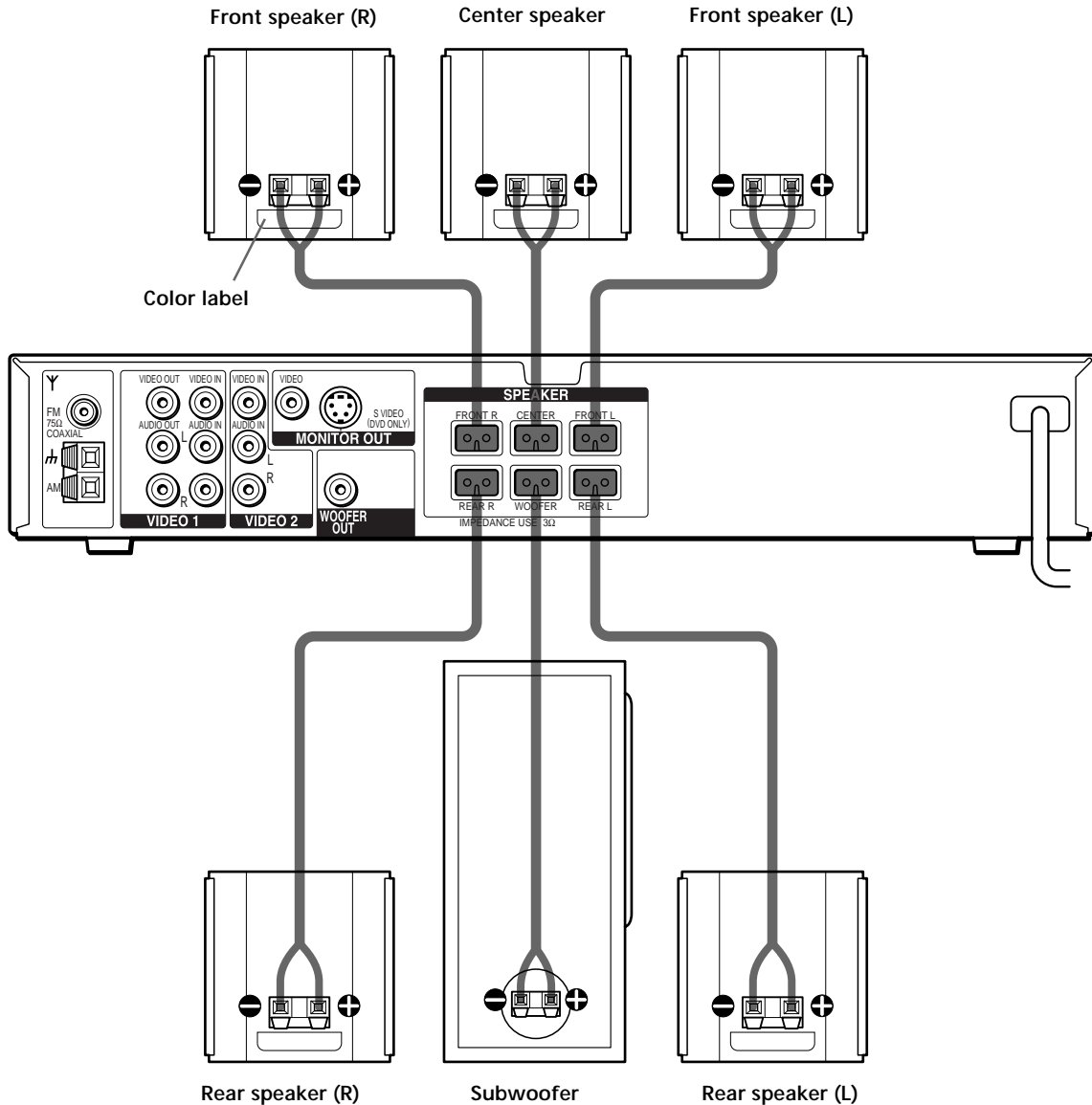
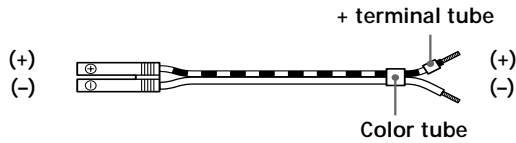

To avoid short-circuiting the speakers

Short-circuiting of the speakers may damage the system. To prevent this, make sure to take the following precautions when connecting the speakers.

Make sure the stripped end of each speaker cord does not touch another speaker terminal or the stripped end of another speaker cord.

Examples of poor conditions of the speaker cord
Stripped speaker cord is touching another speaker terminal.

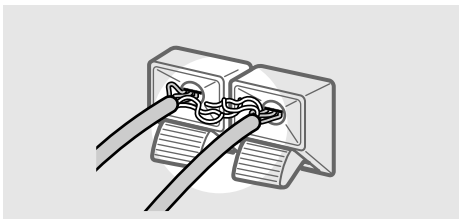

Stripped cords are touching each other due to excessive removal of insulation.

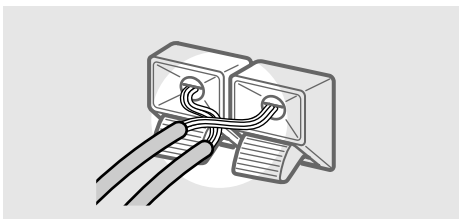

After connecting all the components, speakers, and AC power cord, output a test tone to check that all the speakers are connected correctly. For details on outputting a test tone, see page 14.

If no sound is heard from a speaker while outputting a test tone or a test tone is output from a speaker other than the one whose name is currently displayed on the front panel display, the speaker may be short-circuited. If this happens, check the speaker connection again.

Notes on speaker system hookup

- Be sure to match the speaker cord to the appropriate terminal on the components: + to + and - to -. If the cords are reversed, the sound will be distorted and will lack bass.
- If you use front speakers with low maximum input rating, adjust the volume carefully to avoid excessive output on the speakers.

If you feel lack of bass frequency

Connect an active subwoofer (not supplied) to the WOOFER OUT jack using a monaural audio cord (not supplied).

When you connect an active subwoofer, disconnect the supplied woofer from the SPEAKER WOOFER terminal.

Black  Black

Antenna Hookups

Connect the supplied AM/FM antennas for listening to the radio.

Terminals for connecting the antennas

Connect the	To the
AM loop antenna	AM terminals
FM wire antenna	FM 75Ω COAXIAL terminal

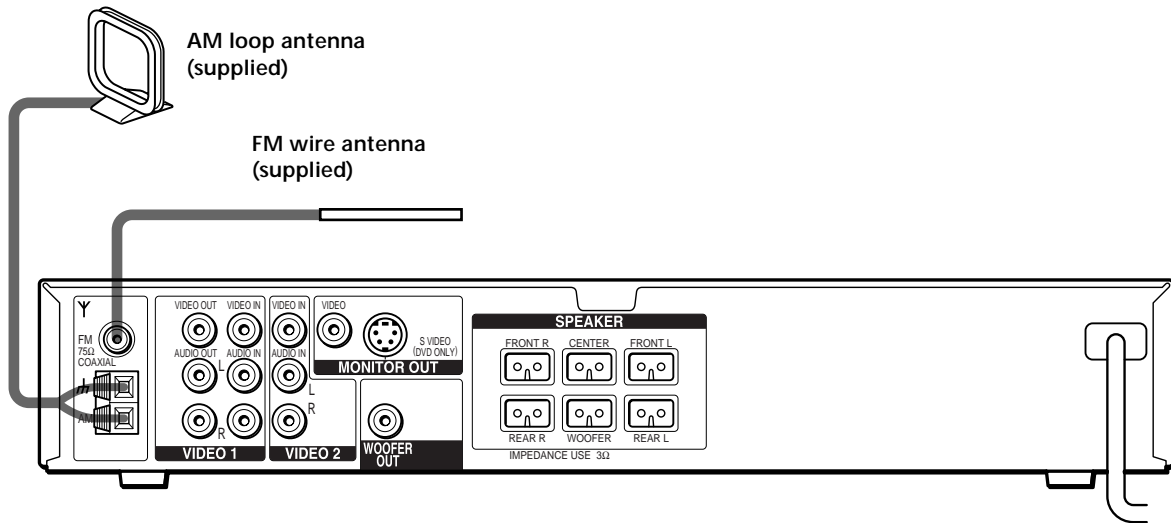

Notes on antenna hookups

- To prevent noise pickup, keep the AM loop antenna away from the system and other components.
- Be sure to fully extend the FM wire antenna.
- After connecting the FM wire antenna, keep it as horizontal as possible.
- When you connect the supplied AM loop antenna, connect the black cord (A) to the π terminal, and the white cord (B) to the other terminal.

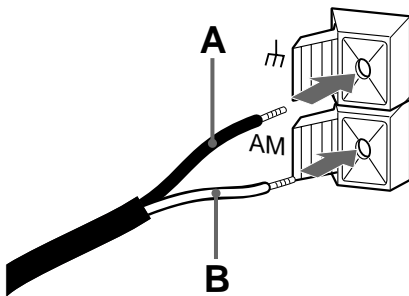

 If you have poor FM reception
Use a 75-ohm coaxial cable (not supplied) to connect the system to an outdoor FM antenna as shown below.

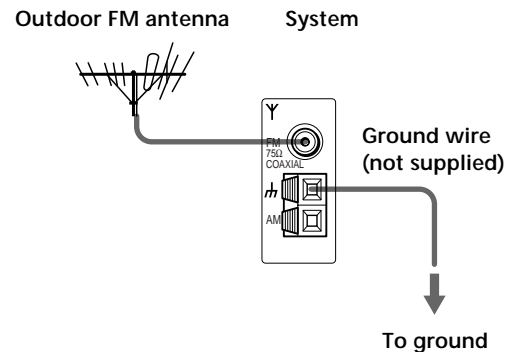

Important

If you connect the system to an outdoor antenna, ground it against lightning. To prevent a gas explosion, do not connect the ground wire to a gas pipe.

TV and Video Component Hookups



Required cords

Video cord for connecting a TV monitor (supplied)

Yellow  Yellow

Audio/video cords (not supplied)

When connecting a cord, be sure to match the color-coded pins to the appropriate jacks on the components.

Yellow (video)  Yellow (video)
 White (L/audio)  White (L/audio)
 Red (R/audio)  Red (R/audio)

Jacks for connecting video components

Connect a	To the
TV monitor	MONITOR OUT jack
VCR	VIDEO 1 jacks
Additional VCR	VIDEO 2 jacks

 When using the S-video jack instead of the video jacks
 Your TV monitor must also be connected via an S-video jack. S-video signals are on a separate bus from the video signals and will not be output through the video jacks.

Note

The VIDEO 1 AUDIO OUT L/R jacks output the same signal as the front L/R speakers. When you select VIDEO 1 using the FUNCTION button, the signal is output from the front L/R speakers, but not from the VIDEO 1 VIDEO OUT and AUDIO OUT L/R jacks.

Setups for the system

Some setups are necessary for the system depending on the TV monitor to be connected.

If the color system of the TV is NTSC or DUAL

Since the color system of the system is set to NTSC, you can use this system as it is.

If the color system of the TV is PAL

To set the system to PAL, turn on the system while pressing the **||** button of the system. To reset to NTSC, turn off the system and then turn on as described above.

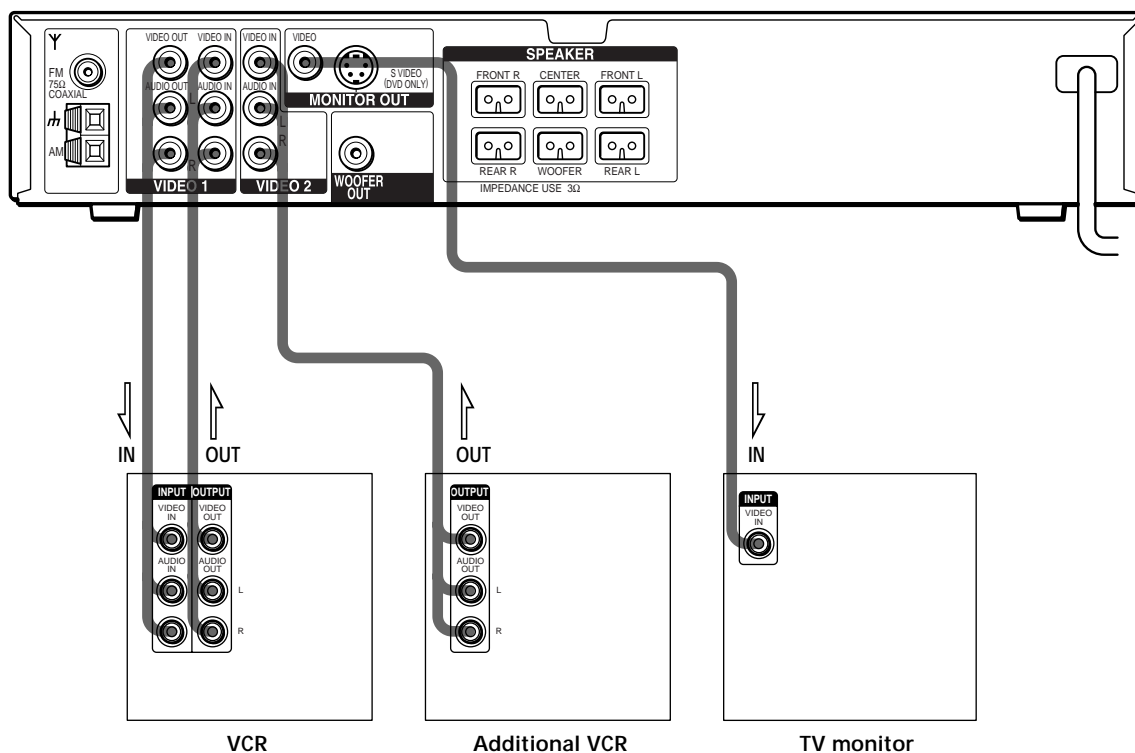

Connecting the AC Power Cord

Before connecting the AC power cord (mains lead) of this system to a wall outlet, connect the speakers to the system (see page 8).

Connect the AC power cords (mains leads) of your TV/video components to a wall outlet.

Selecting the Language for On-Screen Display

You can select the language for the setup display, the Control Menu display or the messages displayed on the screen. The default language is "ENGLISH."

Open the cover.

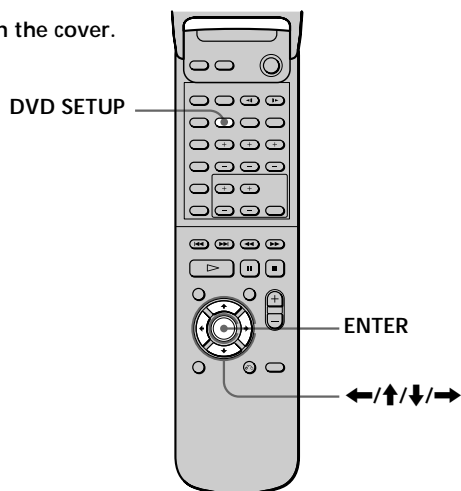

- 1 Press DVD SETUP and select "LANGUAGE SETUP" using ↑/↓, and then press ENTER.

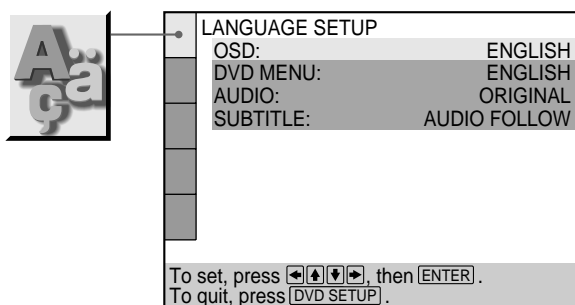

- 2 Select "OSD" using ↑/↓, then press → or ENTER.

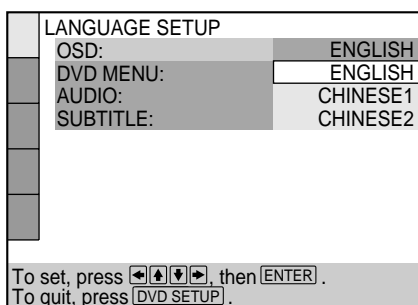

- 3 Select the desired language using ↑/↓, then press ENTER.

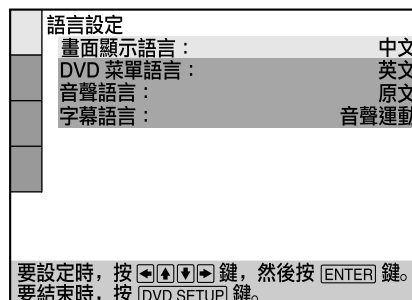

- 4 Press DVD SETUP to exit menu.

To cancel using the setup display

Press DVD SETUP again.

Note

The languages you can select are the ones displayed in Step 2. For details, see page 44.

Speaker Setup

For the best possible surround sound all the speakers other than the subwoofer should be the same distance from the listening position (A).

However, this system lets you place the center speaker up to 1.6 meters closer (B) and the rear speakers up to 4.6 meters closer (C) to the listening position.

The front speakers can be placed from 1.0 to 15.0 meters (A) from the listening position.

You can place the subwoofer at any position.

You can place the rear speakers either behind you or to the side, depending on the shape of your room, etc.

When the rear speakers are placed to the side

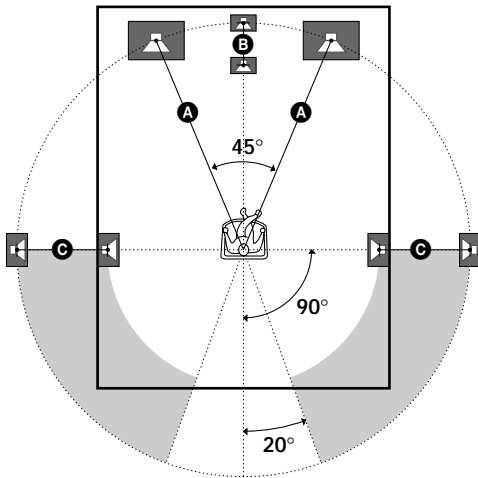

When the rear speakers are placed behind you

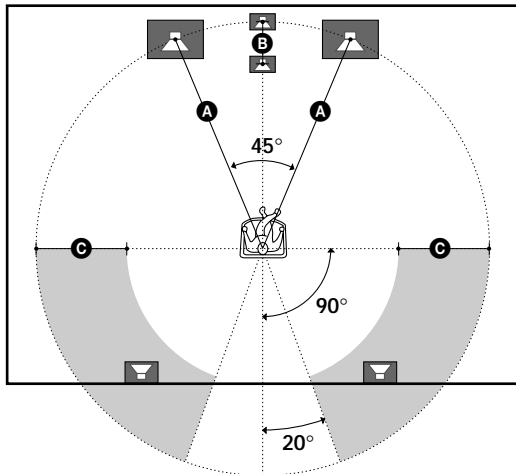

Note

Do not place the center and rear speakers farther away from the listening position than the front speakers.

Specifying the speaker parameters

To obtain the best possible surround sound, first specify the distance of the speakers from your listening position, then set the balance and level. Use the test tone to adjust the speaker volumes to the same level.

Details of each item will follow the description of the operation.

You may adjust the speaker parameters using SPEAKER SETUP in the setup display (p. 49).

Open the cover.

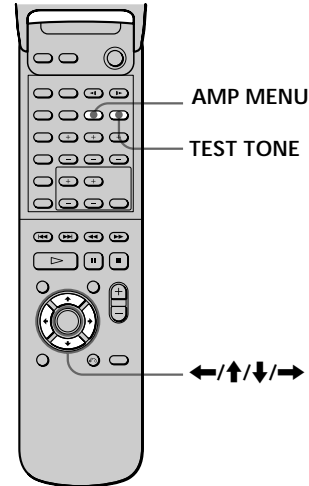

To specify the size, distance, position and height of the speakers

- 1 Press AMP MENU repeatedly to display << SP. >> on the front panel display.
- 2 Sit at your listening position and select the item to be set using \uparrow/\downarrow .
 - Items set in << SP. >>
 - Size of the rear and center speakers
 - Distance of the front, rear and center speakers
 - Position and height of the rear speakers
- 3 Set the parameter using \leftarrow/\rightarrow .
The selected parameter will appear on the front panel display.
- 4 Repeat Steps 2 and 3 to set other parameters within << SP. >>.
If you do not operate the remote for a few seconds, the parameter turns off and is stored in the system.

■ Size

When you do not connect center or rear speakers, or move the rear speakers, set the parameters for CENTER and REAR. Since the front speaker and subwoofer settings are fixed, you cannot change them. The default settings are underlined.

- **CENTER** (center speaker)
 - YES: Normally select this.
 - NO: If you will not connect a center speaker, select this.
- **REAR** (rear speakers)
 - YES: Normally select this. Specify the position and height to implement the Digital Cinema Surround modes in the “Virtual” sound field (p. 20) properly.
 - NO: If you will not connect a rear speaker, select this.

■ Distance

You can vary the distance of each speaker as follows. The default adjustments are in the parentheses.

- **F. DIST.** (5m) (front speakers distance)
Front speaker distance can be set in 0.2 meter steps from 1.0 to 15.0 meters.
- **C. DIST.** (5m) (center speaker distance)
Center speaker distance can be set in 0.2 meter steps from a distance equal to the front speaker distance to a distance 1.6 meters closer to your listening position.
- **R. DIST.** (3.4m) (rear speakers distance)
Rear speaker distance can be set in 0.2 meter steps from a distance equal to the front speaker distance to a distance 4.6 meters closer to your listening position.

Note

If each of the front or rear speakers are not placed an equal distance from your listening position, set the distance of the closest speaker.

■ Position/Height

When you select “YES” in “REAR,” specify the position and height of the rear speakers. The default settings are underlined.

Position diagram

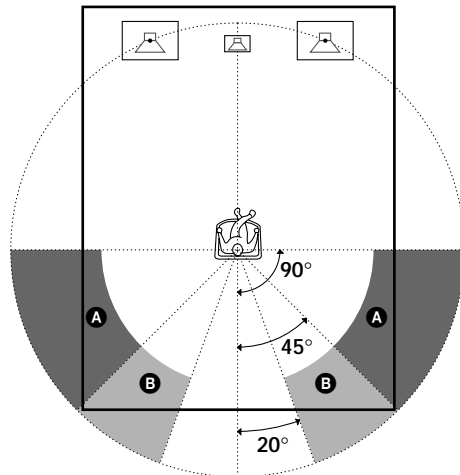

- **R. PL. BEHIND**
Select this if the rear speakers are located in the section **B**.
- **R. PL. SIDE**
Select this if the rear speakers are located in the section **A**.

Height diagram

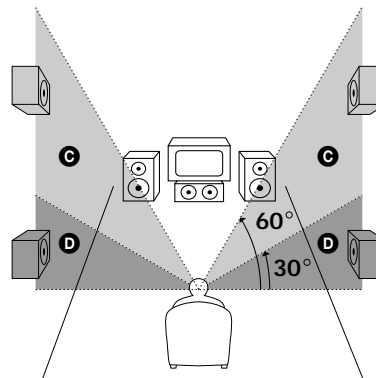

- **R. HGT. LOW**
Select this if the rear speakers are located in the section **D**.
- **R. HGT. HIGH**
Select this if the rear speakers are located in the section **C**.

These parameters are not available when “REAR” is set to “NO”.

Speaker Setup

To specify the balance and level of the speakers

- 1 Press TEST TONE on the remote.
You will hear the test tone from each speaker in sequence.
- 2 Press AMP MENU repeatedly to display <<LEVEL >> on the front panel display.
- 3 Sit at your listening position and select the item to be adjusted using ↑/↓.
 - Items adjusted in << LEVEL >>
 - Balance of the front and rear speakers
 - Volume level of the center and rear speakers and subwoofer
- 4 Adjust the volume level so that the volume of the test tone from each speaker sounds the same using ←/→.
The adjusted value will appear on the front panel display.
- 5 Repeat Steps 3 and 4 to adjust other parameters within <<LEVEL>>.

If you do not operate the remote for a few seconds, the value turns off and is stored in the system.
- 6 Press TEST TONE again to turn off the test tone.

■ Balance

You can vary the balance of each speaker as follows. The default adjustments are in the parentheses.

- F ___|___ (center) (front speakers)
Adjust the balance between the front left and right speakers (6 dB (L) to 6 dB (R), 1 dB steps).
- R ___|___ (center) (rear speakers)
Adjust the balance between the rear left and right speakers (6 dB (L) to 6 dB (R), 1 dB steps).

■ Level

You can vary the level of each speaker as follows. The default adjustments are in the parentheses.

- C. LEVEL (0 dB) (center speaker level)
Adjust the level of the center speaker (-6 dB to +6 dB, 1 dB steps).
- R. LEVEL (0 dB) (rear speakers level)
Adjust the level of the rear speakers (-6 dB to +6 dB, 1 dB steps).
- S. W. LEVEL (0 dB) (subwoofer level)
Adjust the level of the subwoofer (-6 dB to +6 dB, 1 dB steps).

💡 You can adjust the level of center/rear speakers and subwoofer directly

Use the CENTER/REAR/WOOFER +/- buttons on the remote.

Notes

- When you select an item, the sound cuts off for a moment.
- Depending on the settings of other speakers, the subwoofer may output excessive sound.

To adjust the volume of all the speakers at one time

Use the VOLUME control.

Using the optional speaker stands

For greater flexibility in the positioning of the speakers, use the optional WS-FV10 floor stand (available only in certain countries).

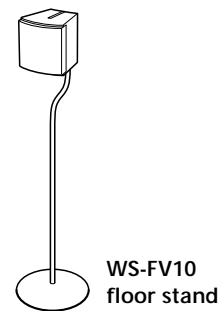

Presetting Radio Stations

You can preset 20 stations for FM and 10 stations of AM. Before tuning, make sure that you have turned down the volume to the minimum.

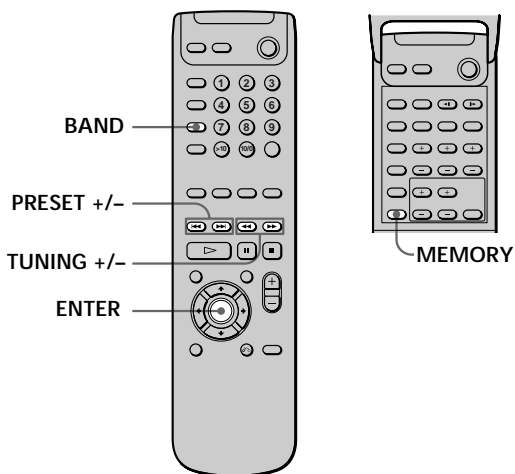

- 1 Press **BAND** repeatedly until the band you want appears on the front panel display. Every time you press **BAND**, FM and AM changes alternately.
- 2 Press and hold **TUNING +** or **-** until the frequency indication starts to change, then release. Scanning stops when the system tunes in a station. "TUNED" and "STEREO" (for stereo program) appear on the front panel display.



- 3 Press **MEMORY**. A preset number appears on the front panel display.



- 4 Press **PRESET +** or **-** to select the preset number you want.

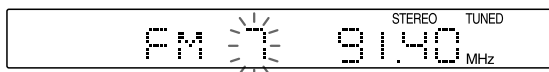

- 5 Press **ENTER**. The station is stored.



- 6 Repeat Steps 1 to 5 to store other stations.

To tune in a station with a weak signal

Press **TUNING +** or **-** repeatedly in Step 2 to tune in the station manually.

To change the preset number

Start over from Step 1.

To change the AM tuning interval

The AM tuning interval is factory set to 9 kHz. To change the AM tuning interval, tune in any AM station first, then turn off the power. While holding down the **ENTER** button, turn the power back on. When you change the interval, AM preset stations will be erased. To reset the interval, repeat the same procedure.

Playing Discs

This chapter describes how to play a DVD/CD/VIDEO CD.

Playing Discs

Depending on the DVD or VIDEO CD, some operations may be different or restricted. Refer to the instructions supplied with your disc.

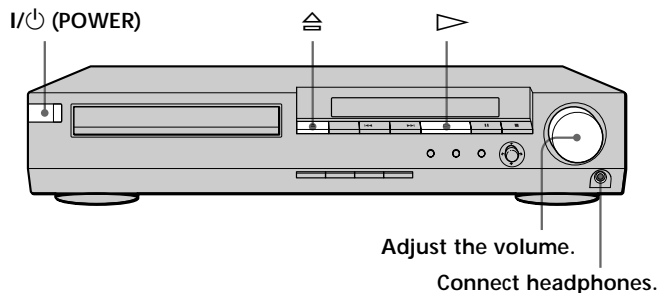

- 1 Turn on the TV and select the video input so that you can view the pictures from this system.
- 2 Press I/⏻ (POWER) to turn on the system. The I/⏻ (POWER) button changes to green and the front panel display lights up.
- 3 Press , and place the disc on the disc tray.

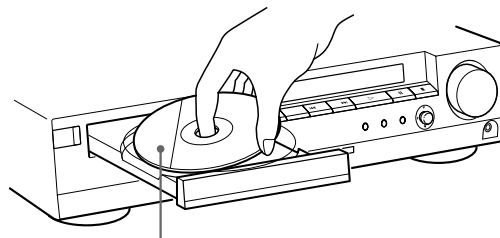

With the playback side facing down

- 4 Press . The disc tray closes, and the system starts playback (continuous play). Adjust the volume by rotating VOLUME.

After following Step 4

■ When playing a DVD

A DVD menu or title menu may appear on the TV screen (see page 24).

■ When playing a VIDEO CD

The menu screen may appear on the TV screen depending on the VIDEO CD. You can play the disc interactively, following the instructions on the menu screen. (PBC Playback, see page 25.)

 You can turn on the system using the remote
Press I/⏻ (POWER) when the indicator by the I/⏻ (POWER) button on the front panel is lit in red.

Notes

- If you leave the system in pause or stop mode for 15 minutes, the screen saver image appears automatically. To make the screen saver image go away, press ▷. (If you want to set the screen saver function to off, see page 45.)
- The indicator by the I/⏻ (POWER) button lights up in red when the power is turned off.

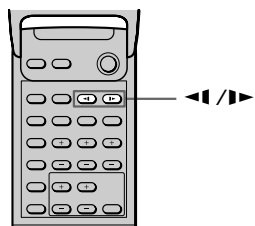
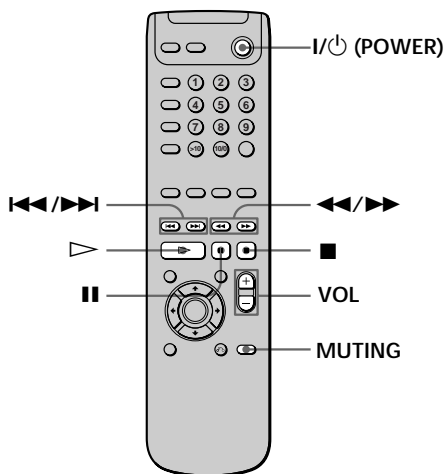
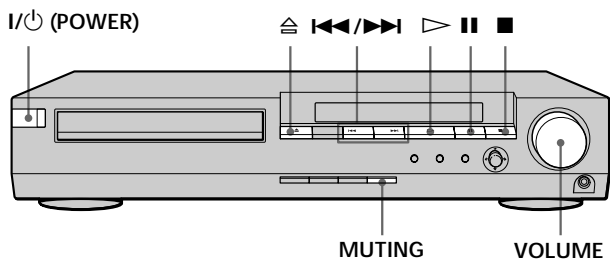

To	Operation
Adjust the volume	Rotate VOLUME or press VOL +/-.
Stop	Press ■.
Pause	Press ■■.
Resume play after pause	Press ■■ or ▷.
Locate a point quickly	Press ◀◀ or ▶▶ while playing a disc. When you find the point you want, press ▷ to return to the normal speed.
Play in slow motion	Press ◀◀ or ▶▶.
Go to the next chapter, track or scene in continuous play mode	Press ▶▶▶.
Go back to the preceding chapter, track or scene in continuous play mode	Press ◀◀◀.
Mute the sound	Press MUTING. To cancel muting, press it again or turn up the volume.
Stop play and remove the disc	Press ⏻.

Selecting a Sound Field

You can enjoy surround sound simply by selecting one of the pre-programmed sound fields according to the program you want to listen to.

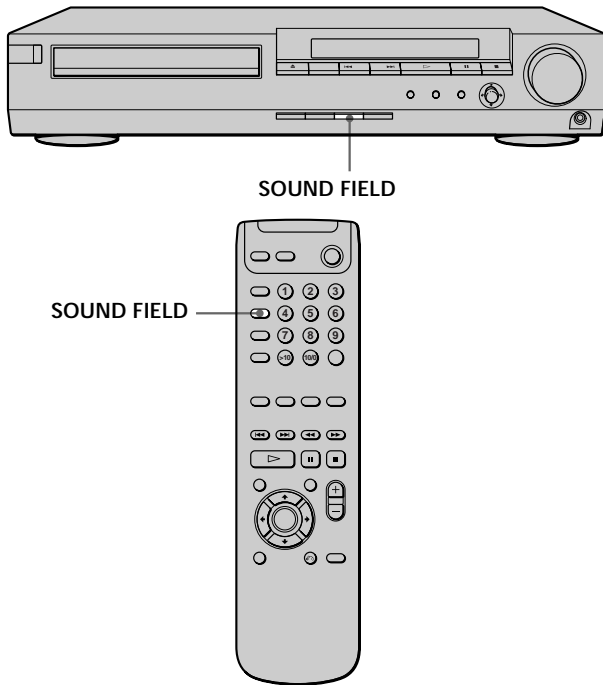

Playing Discs

Press **SOUND FIELD** repeatedly until the sound field you want appears on the front panel display. See the table below for information on each sound field.

To check the current sound field

Press **DISPLAY** repeatedly.

Each time you press **DISPLAY**, the front panel display switches:

remaining or playing time → sound field → remaining or playing time

 The system memorizes the last sound field selected for each program source (Sound Field Link)

Whenever you select a program source, the sound field that was last applied is automatically applied again. For example, if you listen to DVD with HALL as the sound field, change to a different program source, then return to DVD, HALL will be applied again. With the tuner, sound fields are memorized separately for all preset stations.

 You can identify the encoding format of program software by looking at its packaging

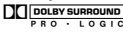
- Dolby Digital discs are labeled with the  logo.
- Dolby Surround encoded programs are labeled with the  logo.
- DTS Digital Surround discs are marked with DTS.

Note

When you play sound tracks with 96 kHz sampling frequency, the output signals will be converted to 48 kHz (sampling frequency).

Sound field	Effect	Notes
AUTO FORMAT DECODE	Automatically detects the type of audio signal being input (Dolby Digital, DTS, Dolby Pro Logic, or standard 2 channel stereo) and performs the proper decoding if necessary. This mode presents the sound as it was recorded/encoded, without adding any effects.	You can use this mode as a reference.
NORMAL SURROUND	Software with multichannel surround audio signals is played according to the way it was recorded. Software with 2 channel audio signals, is decoded with Dolby Pro Logic to create surround effects.	
CINEMA STUDIO A*	Reproduces the sound characteristics of the Sony Pictures Entertainment "Cary Grant Theater" cinema production studio.	This is a standard mode, great for watching most any type of movie.
CINEMA STUDIO B*	Reproduces the sound characteristics of the Sony Pictures Entertainment "Kim Novak Theater" cinema production studio.	This mode is ideal for watching science-fiction or action movies with lots of sound effects.
CINEMA STUDIO C*	Reproduces the sound characteristics of the Sony Pictures Entertainment scoring stage.	This mode is ideal for watching musicals or classic films where music is featured in the soundtrack.

* "VIRTUAL" sound field: Sound field with virtual speakers.

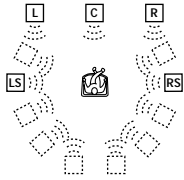
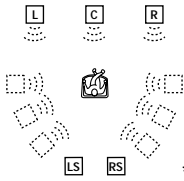
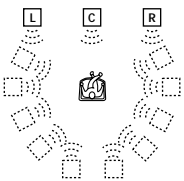
Sound field	Effect	Notes
V. MULTI DIMENSION* (Virtual Multi Dimension)	Uses 3D sound imaging to create an array of virtual rear speakers positioned higher than the listener from a single pair of actual rear speakers. This mode creates 5 sets of virtual speakers surrounding the listener at approximately a 30° angle of elevation.	<p>SIDE*</p>  <p>BEHIND*</p>  <p>* See page 15.</p>
V. SEMI-M. DIMENSION* (Virtual Semi Multi Dimension)	Uses 3D sound imaging to create virtual rear speakers from the sound of the front speakers without using actual rear speakers. This mode creates 5 sets of virtual speakers surrounding the listener at a 30° angle of elevation.	
HALL	Reproduces the acoustics of a rectangular concert hall.	Ideal for soft acoustic sounds.
JAZZ CLUB	Reproduces the acoustics of a jazz club.	
LIVE HOUSE	Reproduces the acoustics of a 300-seat live house.	Great for rock or pop music.
GAME	Obtains maximum audio impact from video game software.	Be sure to set the game machine to stereo mode when using game software with stereo sound capabilities.
2 CH STEREO	Outputs the sound from the front left and right speakers and subwoofer. Standard two channel (stereo) sources completely bypass the sound field processing. Multi channel surround formats are downmixed to two channels.	This allows you to play any source using only the front left and right speakers and subwoofer.

* "VIRTUAL" sound field: Sound field with virtual speakers.

Notes

- The effects provided by the virtual speakers may cause increased noise in the playback signal.
- When listening to sound fields that employ the virtual speakers, you will not be able to hear any sound coming directly from the rear speakers.

Customizing Sound Fields

By adjusting the surround parameters of the front, rear and center speakers, you can customize the sound fields to suit your particular listening situations.

Once you customize a sound field, the changes are stored in memory indefinitely (unless the system is unplugged for about a day). You can change a customized sound field any time by making new adjustments to the parameters.

See the table below for the parameters available in each sound field.

To get the most from multichannel surround sound

Position your speakers and do the procedures described in “Speaker Setup” starting on page 14 before you customize a sound field.

Adjusting the level parameters

The level menu contains parameters that let you adjust the balance and speaker volumes of each speaker. For details of each parameter, refer to “■Balance” and “■Level” on page 16.

- 1 Start playing a program source encoded with multichannel surround sound.
- 2 Press AMP MENU repeatedly on the remote. << LEVEL >> appears on the front panel display.
- 3 Sit at your listening position and select the item to be adjusted using ↑/↓.
- 4 Adjust the volume level using ←/→.
The adjusted value will appear on the front panel display. If you do not operate the remote for a few seconds, the value turned off and is stored in the system.

 You can adjust the level of center/rear speakers and subwoofer directly
Use the CENTER/REAR/WOOFER +/- buttons on the remote.

Adjustable parameters for each sound field

	FRONT BAL.	REAR BAL.	REAR LEVEL	CENTER LEVEL	WOOFER LEVEL
AUTO FORMAT DECODE	●	●	●	●	●
NORMAL SURROUND	●	●	●	●	●
CINEMA STUDIO A	●	●	●	●	●
CINEMA STUDIO B	●	●	●	●	●
CINEMA STUDIO C	●	●	●	●	●
V. MULTI DIMENSION	●	●	●	●	●
V. SEMI-M. DIMENSION	●			●	●
HALL	●	●	●	●	●
JAZZ CLUB	●	●	●	●	●
LIVE HOUSE	●	●	●	●	●
GAME	●	●	●	●	●
2 CH STEREO	●				●

Resuming Playback from the Point Where You Stopped the Disc (Resume Play)

The system stores the point where you stopped the disc and when “RESUME” appears on the front panel display, you can resume playback from that point. As long as you do not open the disc tray, Resume Play is available even if you turn the power off.

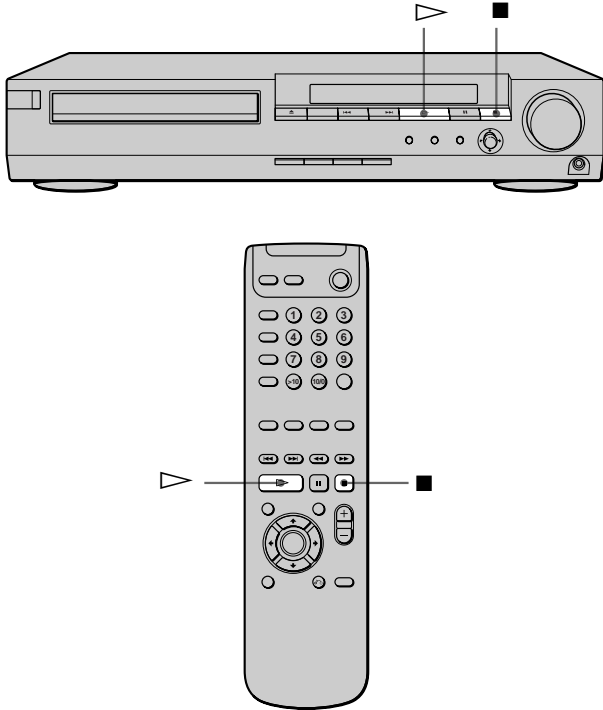

Notes

- Resume Play may not be available depending on the DVD.
- Resume Play is not available in Shuffle or Program Play mode.
- Depending on where you stopped the disc, the system may resume playback from a different point.
- The point where you stopped playing is cleared when:
 - you open or close the disc tray
 - you disconnect the AC power cord without turning the power off
 - you change the play mode
 - you start playback after selecting a title, chapter or track
 - you change the settings of “TV TYPE” in “SCREEN SETUP” in the setup display
 - you change the settings of “PARENTAL CONTROL” in “CUSTOM SETUP” in the setup display

1 While playing a disc, press ■ to stop playback. “RESUME” appears in the front panel display and “When playing next time, disc restarts from point you stopped.” appears on the TV screen. If “RESUME” does not appear, Resume Play is not available.

2 Press ▷. The system starts playback from the point where you stopped the disc in Step 1.

 To play from the beginning of the disc

When the playing time appears on the front panel display before you start playing, press ■ again to reset the playing time, then press ▷.

Using the Menu for Each DVD

Using the title menu

A DVD is divided into long sections of a picture or a music piece called “titles.” When you play a DVD which contains several titles, you can select the title you want using the title menu.

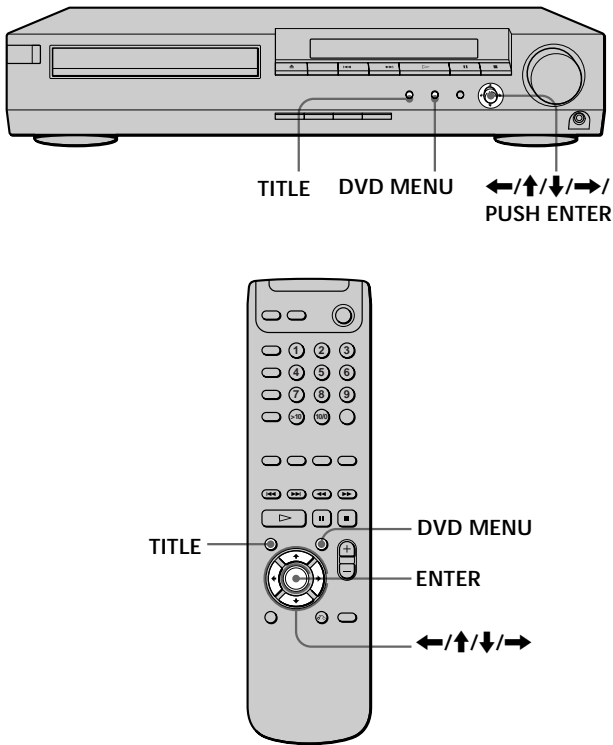

- 1 Press TITLE.**
The title menu appears on the TV screen. The contents of the menu vary from disc to disc.
- 2 Press ←/↑/↓/→ to select the title you want to play.**
Depending on the disc, you can use the number buttons to select the title.
- 3 Press ENTER.**
The system starts playing the selected title.

Notes

- Depending on the DVD, you may not be able to select the title.
- Depending on the DVD, a “title menu” may simply be called a “menu” or “title” in the instructions supplied with the disc. “Press ENTER.” may also be expressed as “Press SELECT.”

Using the DVD menu

Some DVDs allow you to select the disc contents using the menu. When you play these DVDs, you can select the language for the subtitles, the language for the sound, etc., using the DVD menu.

- 1 Press DVD MENU.**
The DVD menu appears on the TV screen. The contents of the menu vary from disc to disc.
- 2 Press ←/↑/↓/→ to select the item you want to change.**
Depending on the disc, you can use the number buttons to select the item.
- 3 To change other items, repeat Step 2.**
- 4 Press ENTER.**

 If you want to select the language for the DVD menu Change the setting using “LANGUAGE SETUP” in the setup display. For details, see page 44.

Note

Depending on the DVD, a “DVD menu” may simply be called a “menu” in the instructions supplied with the disc.

Playing VIDEO CDs with PBC Functions (PBC Playback)



When playing VIDEO CDs with PBC functions (Ver. 2.0 discs), you can enjoy simple interactive operations, operations with search functions, etc. PBC Playback allows you to play VIDEO CDs interactively, following the menu screen on the TV screen. On this system, you can use the number buttons, ENTER, ◀▶, ⏪, ⏩, ⏮, ⏭ and ⏪RETURN during PBC Playback.

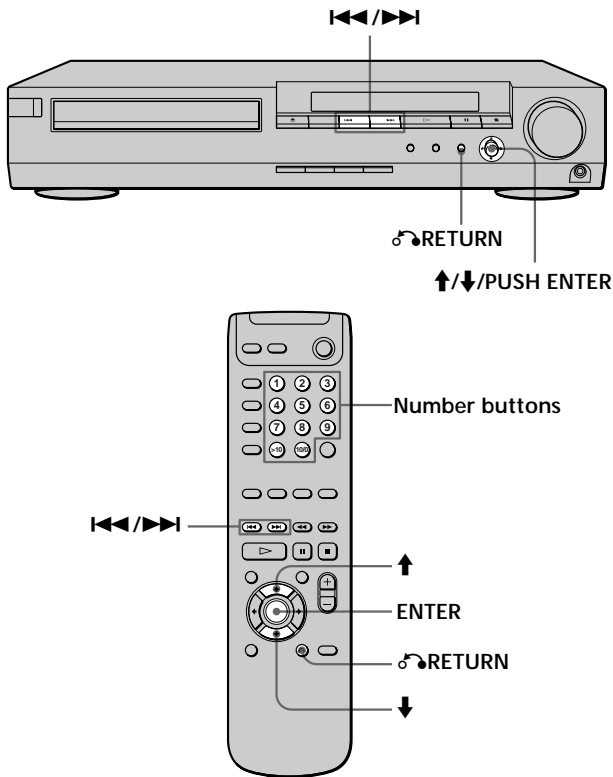

- 1 Start playing a VIDEO CD with PBC functions, following Steps 1 to 4 in "Playing Discs" on page 18.
- 2 Select the item number you want.
On the system
Press ⏮/⏭ to select the item number.
On the remote
Press the number button of the item you want.
- 3 Press ENTER.
- 4 Follow the instructions on the menu screen for interactive operations.
Refer to the instructions supplied with the disc, as the operating procedure may differ according to the VIDEO CD.

Going back to the menu screen

Press ⏪RETURN, ◀▶, or ⏩.

💡 When playing VIDEO CDs with PBC functions PBC playback starts automatically.

💡 To cancel PBC playback of a VIDEO CD with PBC functions and play the disc in Continuous Play mode

There are two ways.

- Before you start playing, select the track you want using ◀▶ or ⏩, then press ENTER or ▷.
- Before you start playing, select the track number using the number buttons on the remote, then press ENTER or ▷. "Play without PBC" appears on the TV screen and the system starts Continuous Play. You cannot play still pictures such as a menu screen. To return to PBC playback, press ■ twice then press ▷.

Note

Depending on the VIDEO CD, "Press ENTER." in Step 3 may be expressed as "Press SELECT." in the instructions supplied with the disc.

Creating Your Own Program (Program Play)



You can play the contents of the disc in the order you want by arranging the order of the titles, chapters or tracks on the disc and create your own program. One program can be restored in the system and contain up to 99 titles, chapters and tracks.

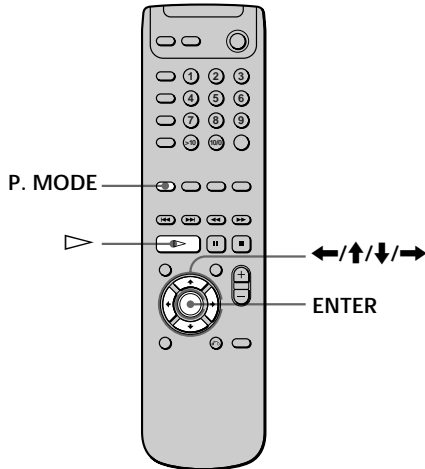

1 In stop mode, press P. MODE on the remote repeatedly until "PROGRAM" appears on the front panel display.

The programming display appears on the TV screen.

"TRACK" is displayed when you play a VIDEO CD or a CD.

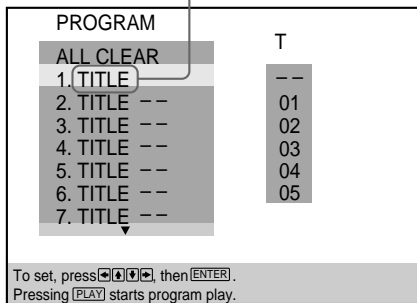

2 Press →.

"01" is highlighted. It is ready to set the first title or track for program.

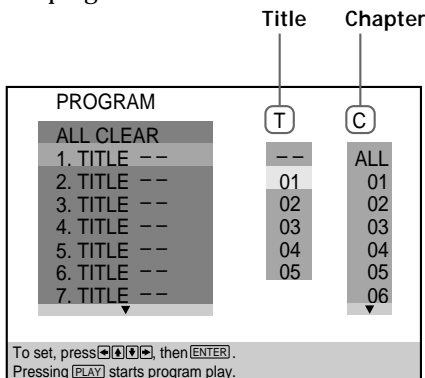

3 Select the title, chapter or track you want to program using ↑/↓, then press ENTER.

For example, select title or track 2.

(You can also use the number buttons and ENTER button to select. In this case, the selected number is displayed on the screen.)

■ When playing a DVD

When both titles and chapters are recorded on the disc, select the title, then the chapter.

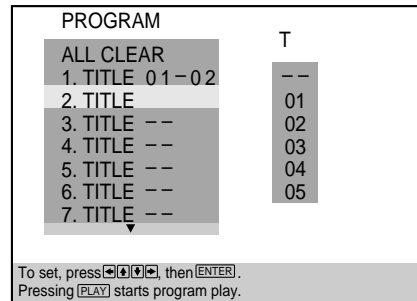
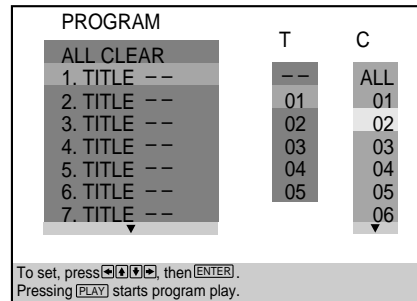

■ When playing a VIDEO CD or CD

Select the track you want to program.

Total time of the programmed tracks

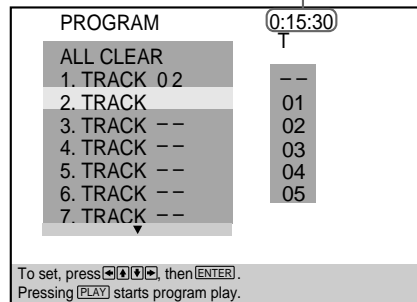

4 To program other titles, chapters or tracks, repeat Step 3.

The programmed titles, chapters or tracks are displayed from 2 in order.

5 Press \triangleright to start Program Play.

To cancel Program Play

Press CLEAR.

To change programming

1 In Step 2, select the program number of the title, chapter or track you want to change using \uparrow/\downarrow .

2 Follow Step 3 for new programming.

To cancel the programmed order

To cancel all the titles, chapters or tracks in the programmed order, select "ALL CLEAR" in Step 2.

To cancel the selected program, select the program using \uparrow/\downarrow in Step 2 then press CLEAR, or select "- -" in Step 3 then press ENTER.

 The program remains even after the Program Play ends. When you press \triangleright , you can play the same program again.

 You can do Repeat Play of the programmed titles, chapters or tracks.

During Program Play, set "REPEAT" to "ON" in the Control Menu display.

Notes

- The number of titles, chapters or tracks recorded on a disc is displayed.
- The program is canceled when:
 - you open or close the disc tray
 - you turn the power off
 - you change the function
- You may not be able to do Program Play depending on the DVD.

Playing in Random Order (Shuffle Play)



The system "shuffles" chapters or tracks and plays them in a random order. The playing order may differ from the previous "shuffling."

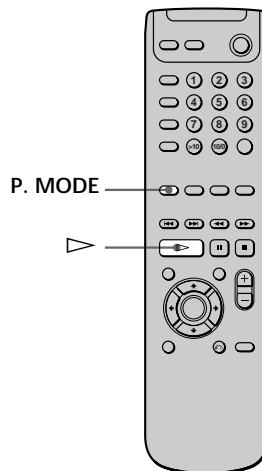

1 In stop mode, press P. MODE on the remote repeatedly until "SHUFFLE" appears on the front panel display.

2 Press \triangleright .

To cancel Shuffle Play, press CLEAR.

Notes

- Shuffle Play is canceled when:
 - you open or close the disc tray
 - you turn the power off
 - you change the function
- You may not be able to do Shuffle Play depending on the DVD.

Using the Front Panel Display



You can check information about the disc, such as the total number of the titles or the tracks or remaining time, using the front panel display.

Open the cover.

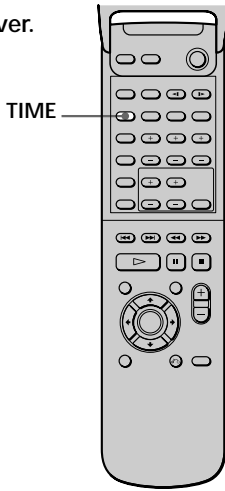

Playing Discs

You can turn off the front panel display. Press DIMMER on the remote. To turn the display on, press it again.

When playing back a DVD

Display information while playing the disc

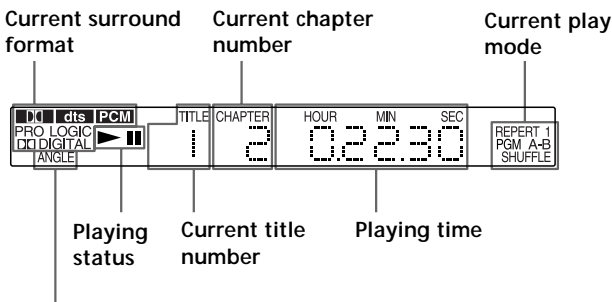

Lights up when you can change the angle

Checking the remaining time

Press TIME.

Each time you press TIME while playing the disc, the display changes as shown in the following chart.

Playing time and number of the current chapter



Press TIME.

Remaining time of the current chapter



Press TIME.

Playing time and number of the current title

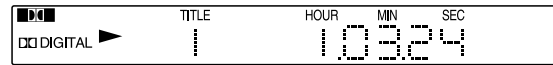

Press TIME.

Remaining time of the current title



Press TIME.

Notes

- Depending on the DVD, the chapter number or time may not appear or you may not be able to change the front panel display.
- While you are doing Shuffle Play or Program Play, the playing time of the title and the remaining time of the title are not displayed.

When playing back a CD/VIDEO CD



Display information while playing a disc

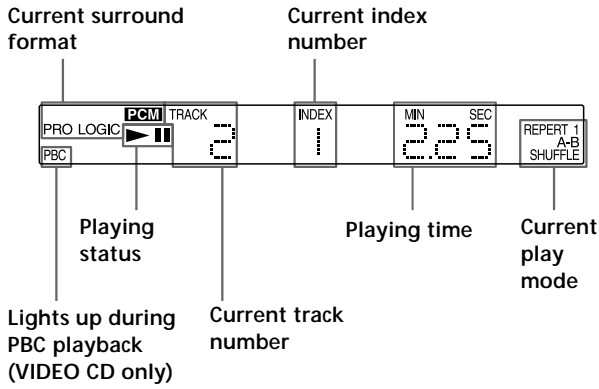

Checking the remaining time

Press TIME.

Each time you press TIME while playing a disc, the display changes as shown in the following chart.

Playing time and number of the current track

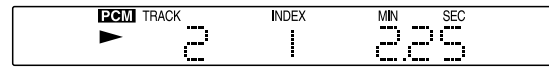

Press TIME.

Remaining time of the current track



Press TIME.

Playing time of the disc



Press TIME.

Remaining time of the disc



Press TIME.

Note

While you are doing Shuffle Play, Program Play, or PBC playback, the playing time of the disc and the remaining time of the disc are not displayed.

Using Various Functions with the Control Menu

This chapter describes how to play discs in various modes and how to use the convenient features of the on-screen menu (Control Menu).

Using the Control Menu Display

Using the Control Menu display, you can select the start point, change the angles, etc. The items are different depending on the kind of disc. For details on each Control Menu display item, see pages 32 to 40.

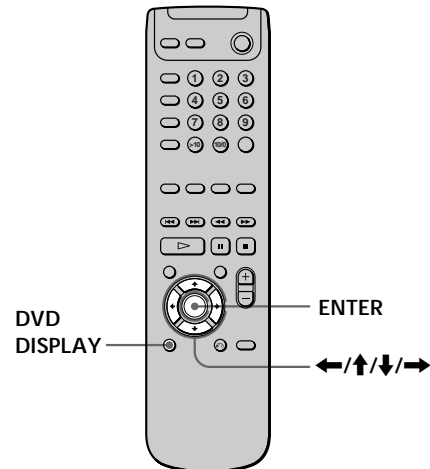

- 1 Press DVD DISPLAY to show the Control Menu display on the TV screen.

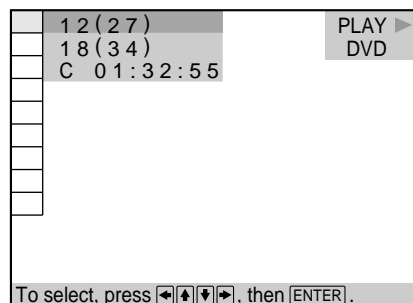

2 Select the item you want using **↑/↓**, then press **→** or **ENTER**.

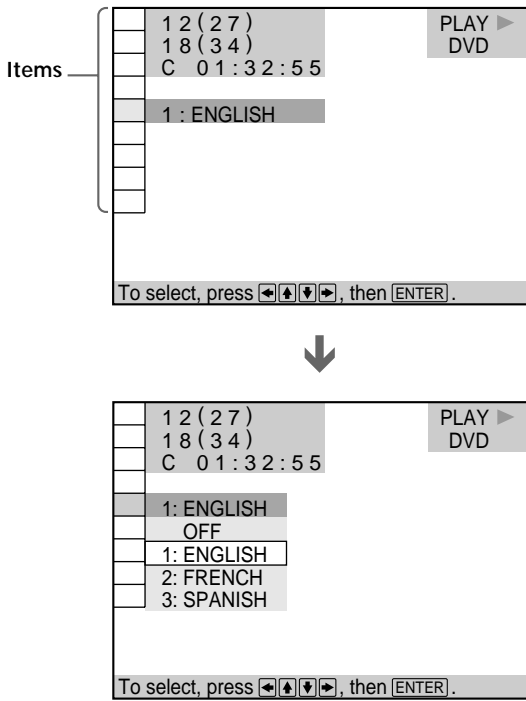

Note

Some Control Menu display items require operations other than selecting the setting. For details on these items, see the relevant pages.

To cancel using the Control Menu display

Press **↶**RETURN.

To display other items

Each time you press DVD DISPLAY, the Control Menu display changes as follows:

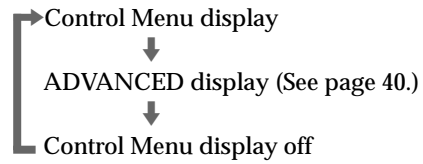

You can display some items using the remote

Some items can be displayed by pressing the button of the remote. In this case, only the item you selected is displayed. For the item and operations using the remote, see the pages of each item.

3 Select the item you want using **↑/↓**, then press **ENTER**.

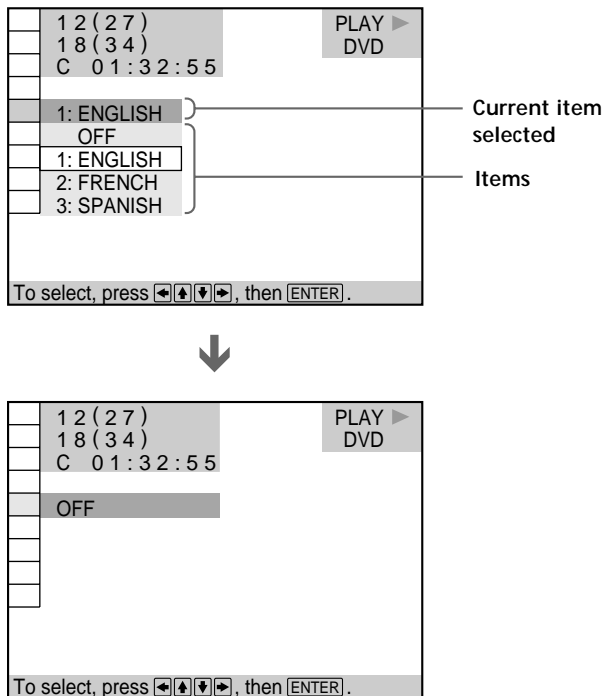

Control Menu Item List

- TITLE** (DVD only) (page 32)
- CHAPTER** (DVD only) (page 32)
- TRACK** (VIDEO CD/CD only) (page 32)
- INDEX** (VIDEO CD/CD only) (page 32)
- SCENE** (VIDEO CD during PBC playback only)

(page 32)

You can search by selecting the title/chapter/track/index/scene.

TIME (pages 33, 34)

You can check the playing time and remaining time of the current title/chapter/track and the total remaining time of the disc.

You can search by inputting the time code.

AUDIO (page 35)

With DVDs recorded with multilingual sounds, you can select the language you want while playing the DVD. With multiplex CDs or VIDEO CDs, you can select the sound from the right or left channel and listen to the sound of the selected channel through both the right and left speakers.

SUBTITLE (DVD only) (page 36)

With DVDs on which multilingual subtitles are recorded, you can change the subtitle language whenever you want while playing the DVD, and turn it on or off whenever you want.

ANGLE (DVD only) (page 37)

With DVDs on which various angles (multi-angles) are recorded, you can change the angles on the scene for which multi-angles are recorded.

REPEAT (page 38)

You can play all the titles/tracks on a disc or a single title/chapter/track repeatedly.

A-B REPEAT (page 38)

You can play a specific portion of a title, chapter, or track repeatedly.

ADVANCED (DVD only) (page 40)

You can check the play information about the bit rate, bit rate history or the position where the disc is played (layer).

Searching for the Title/Chapter/Track/Index/Scene



You can search by selecting the title/chapter/track/index/scene.

Select "TITLE," "CHAPTER," "TRACK," "INDEX" or "SCENE" after pressing DVD DISPLAY.

When you play back a DVD, "TITLE" and "CHAPTER" are displayed.

When you play back a VIDEO CD/CD, "TRACK" and "INDEX" are displayed. When you play back a VIDEO CD with PBC functions, "SCENE" is displayed.

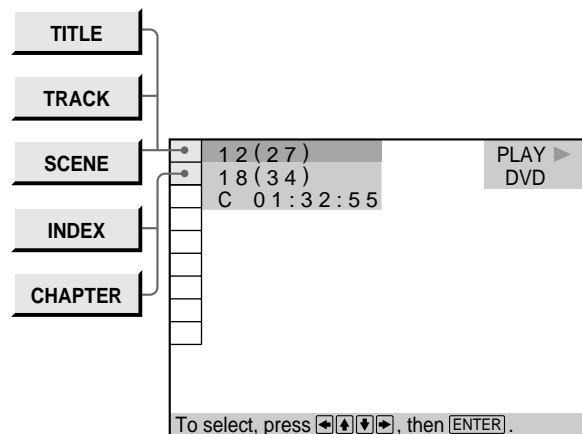

- 1 Select "TITLE," "CHAPTER," "TRACK," "INDEX" or "SCENE" using \uparrow/\downarrow .
 "*" * (* *)" is highlighted. (* * means optional number in this manual.) The number in parentheses indicates the total number of titles, chapters, tracks, indexes or scenes.

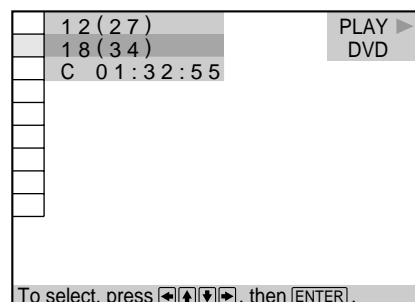

2 Press **→** or **ENTER**.

“** (* *)” is changed to “— (* *)”.

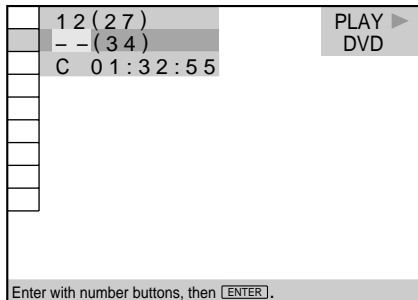

3 Select the number of the title, chapter, track, index or scene you want to search for using the number buttons, then press **ENTER**.

The system starts searching. To cancel the number, press **CLEAR** before pressing **ENTER**.

To cancel selecting

Press **↩**RETURN.

Notes

- The number of titles, chapters or tracks recorded on a disc is displayed.
- The index numbers are not displayed during PBC playback of VIDEO CDs.

Checking the Playing Time and Remaining Time



You can check the playing time and remaining time of the current title/chapter/track and the total remaining time of the disc.

Press **DVD DISPLAY**. Then press **TIME** to change the time information.

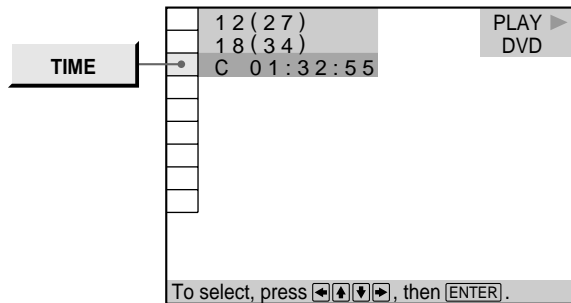

When playing a DVD

■TIME

- C ** : ** : ** : ** : Playing time of the current chapter
- C - ** : ** : ** : ** : Remaining time of the current chapter
- T ** : ** : ** : ** : Playing time of the current title
- T - ** : ** : ** : ** : Remaining time of the current title

When playing a VIDEO CD (during PBC playback)

■TIME

- ** : ** : ** : ** : Playing time of the current scene

When playing a VIDEO CD (in Continuous play) or CD

■TIME

- T ** : ** : ** : ** : Playing time of the current track
- T - ** : ** : ** : ** : Remaining time of the current track
- D ** : ** : ** : ** : Playing time of the current disc
- D - ** : ** : ** : ** : Remaining time of the current disc

You can display the “TIME” display quickly

Press **TIME** on the remote. Each time you press the button, the time information changes.

Selecting a Start Point Using the Time Code

You can search by inputting the time code.
Select "TIME" after pressing DVD DISPLAY.
The time code corresponds to the approximate actual playing time. For example, to search for a scene 2 hours 30 minutes 20 seconds past the beginning, input 2:30:20.

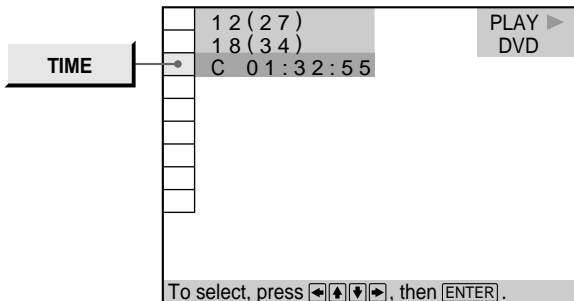

- 3 Input the time code using the number buttons, then press ENTER.
The system starts searching. To cancel the number, press CLEAR before pressing ENTER.

To cancel inputting

Press  RETURN.

Note

When you input the time code, input the playing time of the title.

- 1 Select "C * * : * * : * * " (playing time of the current chapter).

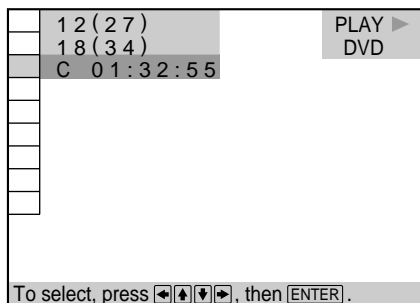

- 2 Press  or ENTER.
Time code changes to "T - - : - - : - -".

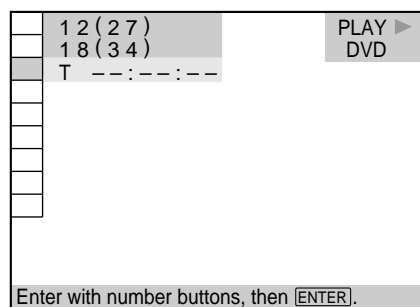

Changing the Sounds

With DVDs recorded with multilingual sounds, you can select the language you want while playing the DVD. With multiplex CDs or VIDEO CDs, you can select the sound from the right or left channel and listen to the sound of the selected channel through both the right and left speakers. In this case, the sound loses the stereo effect. For example, with a disc containing a song, the right channel may output the vocals and the left channel may output the instrumental. If you only want to hear the instrumental, you can select the left channel and hear it from both speakers.

Select "AUDIO" after pressing DVD DISPLAY.

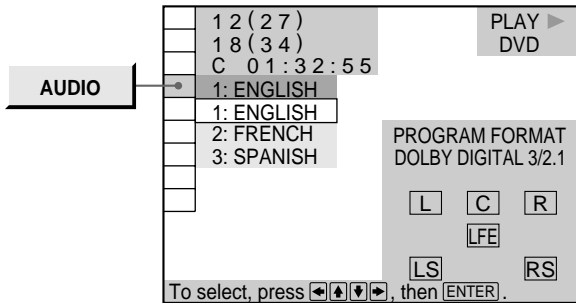

■ AUDIO

When playing a DVD

Select the language. The languages you can select are different depending on the DVD. When 4 digits are displayed, they represent the language code. Select the language code from the list on page 63.

When playing a VIDEO CD or a CD

- **STEREO** : The standard stereo sound
- **1/L** : The sound of the left channel (monaural)
- **2/R** : The sound of the right channel (monaural)

 You can display the "AUDIO" display quickly
Press AUDIO on the remote.

Notes

- Depending on the DVD, you may not be able to change the languages even if multilingual sounds are recorded on the DVD.
- While playing the CD/VIDEO CD, the standard stereo playback will be resumed when:
 - you open or close the disc tray
 - you turn the power off
- While playing the DVD, the sound may be changed when:
 - you open or close the disc tray
 - you change the title
- If the language is displayed as a 4 digit number, refer to the language code list on page 63.

Displaying the audio information of the disc

When you select "AUDIO," the playing channels are displayed on the screen.

In Dolby Digital format, the signals from monaural to 5.1 channels can be recorded on a DVD. Depending on the DVD the number of the recorded channels may be different.

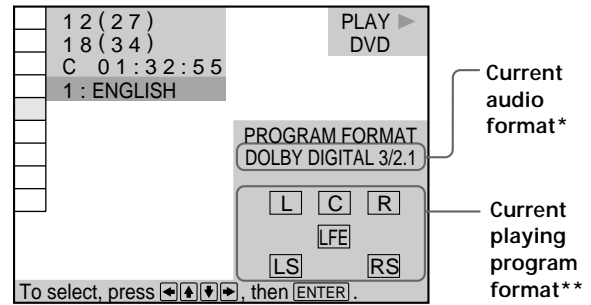

* "PCM," "DTS," "DOLBY DIGITAL" or "MPEG" is displayed. In "DOLBY DIGITAL" case, the channels in the playing track are displayed by number as follows:

The case of Dolby Digital (AC-3) 5.1 ch:

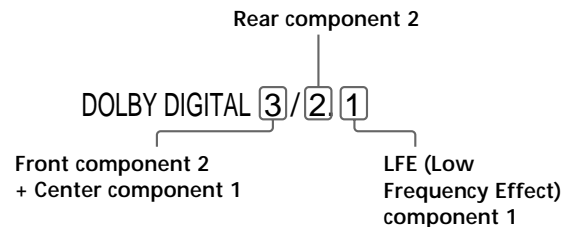

** The letters in the program format display mean the following:

- L: Front (L)
- R: Front (R)
- C: Center (monaural)
- LS: Rear (L)
- RS: Rear (R)
- S: Rear (monaural) – the rear component of the Dolby Surround processed stereo signal and the Dolby Digital signal.
- LFE: LFE (Low Frequency Effect)

The display examples are as follows:

- PCM (stereo)

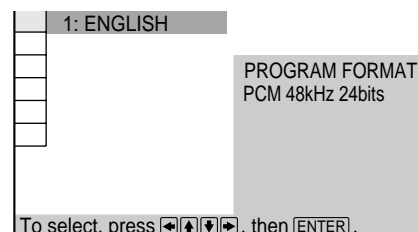

Changing the Sounds

- Dolby Surround

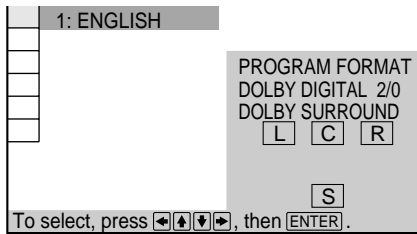

- Dolby Digital 5.1ch

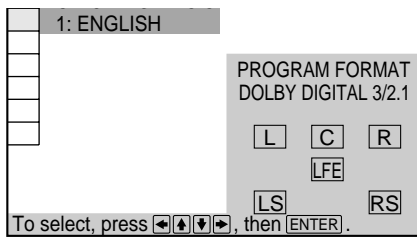

- DTS

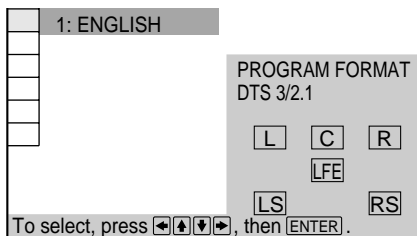

- MPEG

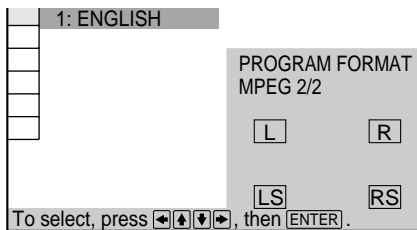

You can find Dolby Surround-encoded software by looking at the packaging

Use discs with the logo. In order to enjoy Dolby Digital playback you must use discs bearing this logo.

Displaying the Subtitles



With DVDs on which subtitles are recorded, you can turn the subtitles on and off whenever you want while playing the DVD.

With DVDs on which multilingual subtitles are recorded, you can change the subtitle language whenever you want while playing the DVD, and turn it on or off whenever you want. For example, you can select the language you want to master and turn the subtitles on for better understanding.

Select "SUBTITLE" after pressing DVD DISPLAY.

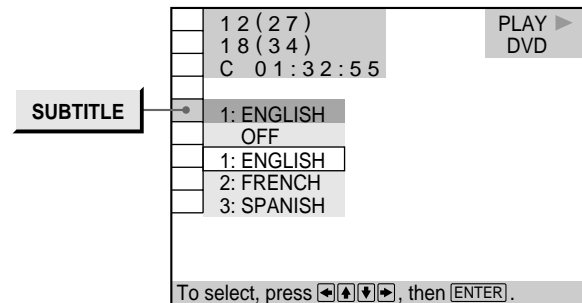

■ SUBTITLE

Select the language. The languages you can select are different depending on the DVD. When 4 digits are displayed, they indicate the language code. Select the language code from the list on page 63.

You can display the "SUBTITLE" display quickly
Press SUBTITLE on the remote. Each time you press the button, the item changes.

Notes

- When playing a DVD on which no subtitles are recorded, no subtitles appear.
- Depending on the DVD, you may not be able to turn the subtitles on even if they are recorded on it.
- Depending on the DVD, you may not be able to turn the subtitles off.
- If the language is displayed as a 4-digit number, refer to the language code list on page 63.
- The type and number of languages for subtitles vary from disc to disc.
- Depending on the DVD, you may not be able to change the subtitles even if multilingual subtitles are recorded on it.
- While playing the DVD, the subtitle may change when:
 - you open or close the disc tray
 - you change the title

Changing the Angles DVD

With DVDs on which various angles (multi-angles) for a scene are recorded, you can change the angles. For example, while playing a scene of a train in motion, you can display the view from either the front of the train, the left window of the train or from the right window without having the train's movement interrupted. Select "ANGLE" after pressing DVD DISPLAY. When the angles can be changed, the indicator of the "ANGLE" lights in green.

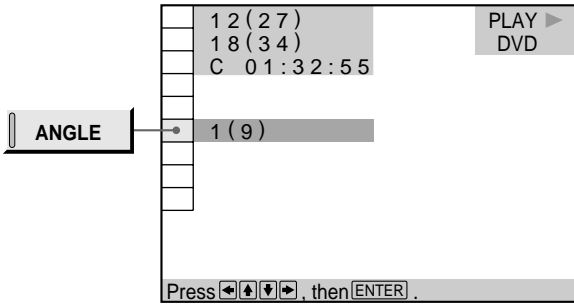

1 Select "ANGLE."

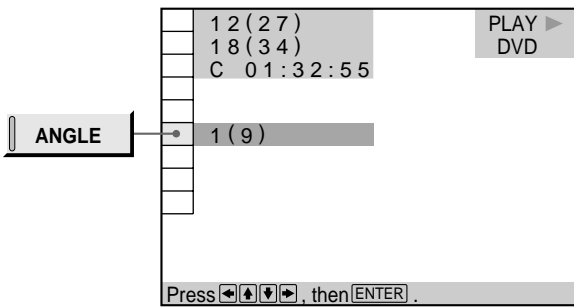

2 Press →.

The number of the angle changes to "-." The number in parentheses indicates the total number of angles.

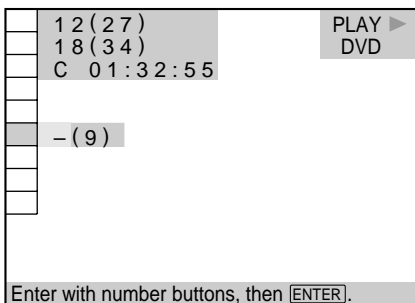

3 Select the number of the angles using the number buttons or ↑/↓, then press ENTER.

The angle is changed to the selected angle.

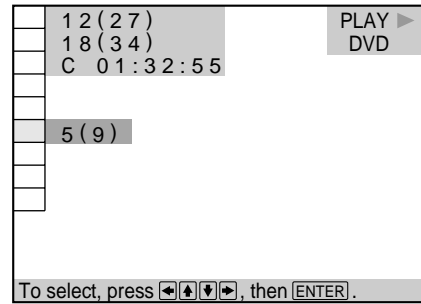

Notes

- The number of angles varies from disc to disc or from scene to scene. The number of angles that can be changed on a scene is that of angles recorded for that scene.
- Depending on the DVD, you may not be able to change the angles even if multi-angles are recorded on the DVD.

You can specify the angle beforehand

Specify the angle when "ANGLE" is not displayed on the front panel display. When a scene on which multi-angles are recorded comes, the angle is automatically selected.

You can select the angle directly

Press ANGLE on the remote. Each time you press the button, the angle changes.

Playing Repeatedly (Repeat Play)



You can play all the titles/tracks on a disc or a single title/chapter/track.

In Shuffle or Program Play mode, the system repeats the titles or tracks in the shuffled or programmed order.

You cannot do Repeat Play during PBC playback of VIDEO CDs (page 25).

You may not be able to do Repeat Play depending on the DVD.

Select "REPEAT" after pressing DVD DISPLAY. When you do not select "OFF," the indicator of the "REPEAT" lights in green.

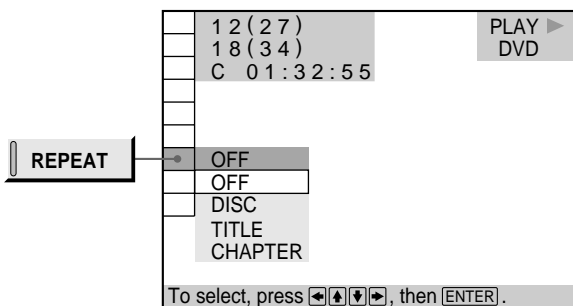

REPEAT

Selects the setting of Repeat Play.

When playing a DVD and when Program Play and Shuffle Play are set to OFF

- **OFF**: does not play repeatedly.
- **DISC**: repeats all the titles.
- **TITLE**: repeats the current title on a disc.
- **CHAPTER**: repeats the current chapter.

When playing a VIDEO CD/CD and when Program Play and Shuffle Play are set to OFF

- **OFF**: does not play repeatedly.
- **DISC**: repeats all the tracks on a disc.
- **TRACK**: repeats the current track

When Program Play or Shuffle Play is set to ON

- **OFF**: does not play repeatedly.
- **ON**: repeats Program Play or Shuffle Play.

To cancel Repeat Play

Press CLEAR.

You can set Repeat Play during stop
After selecting the item of "REPEAT," press \triangleright .
The system starts Repeat Play.

You can display the "REPEAT" display quickly
Press REPEAT on the remote.

Note

Repeat play is canceled when:

- you turn the power off.
- you change the function.

Repeating a Specific Portion (A↔B Repeat)



You can play a specific portion of a title, chapter, track repeatedly. This is useful when you want to memorize lyrics.

During PBC Playback of VIDEO CDs (page 25), this function is available only while playing moving pictures. You may not be able to do A↔B Repeat Play depending on the DVD.

Select "A-B REPEAT" after pressing DVD DISPLAY. During A↔B Repeat Play, the indicator of the "A-B REPEAT" lights in green.

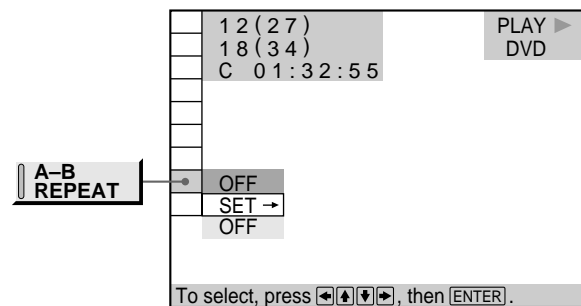

A-B REPEAT

- **SET \rightarrow** : sets the A and B points.
- **OFF**: does not play a specific portion of a title/chapter/track repeatedly.

Setting a portion for A↔B repeat

1 Select "SET →" in "A-B REPEAT."

The A-B REPEAT setting display appears.

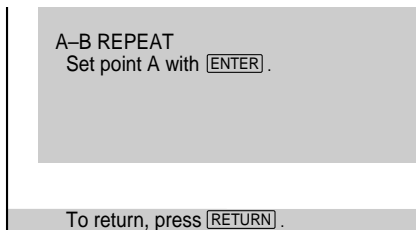
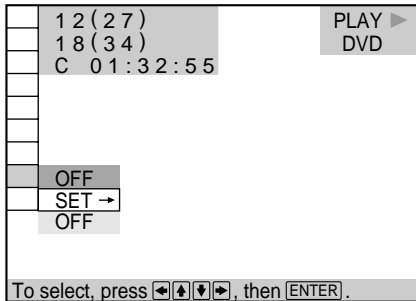

2 During playback, when you find the starting point (point A) of the portion to be played repeatedly, press ENTER.

The starting point (point A) is set.

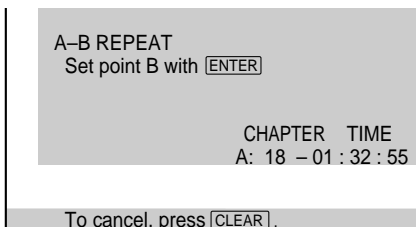

3 When you reach the ending point (point B), press ENTER again.

The setting points are displayed and the system starts repeating this specific portion.

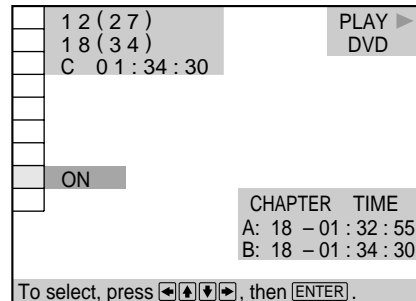

To cancel A↔B Repeat Play

Press CLEAR.

Notes

- You can set A↔B Repeat on only one specific portion.
- A↔B Repeat is canceled when:
 - you open or close the disc tray
 - you turn the power off
- When you set A↔B Repeat, the settings for Shuffle Play and Program Play are canceled.
- You may not be able to set A↔B Repeat, depending on the scene of the DVD or the VIDEO CD.

Checking the Play Information

You can check the play information on the bit rate, bit rate history or the portion where the disc is played (layer). While playing a disc, the approximate bit rate of the playback picture is always displayed by Mbps (Mega bit per second) and the audio by kbps (kilo bit per second). Select "ADVANCED" after pressing DVD DISPLAY.

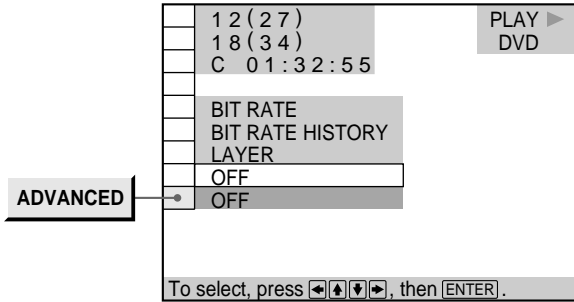

■ ADVANCED When playing a DVD

- **BIT RATE:** displays bit rate.
- **BIT RATE HISTORY:** displays bit rate and bit rate history.
- **LAYER:** displays layer and the point picked up.
- **OFF:** turns off the ADVANCED display.

Displays of each item

BIT RATE

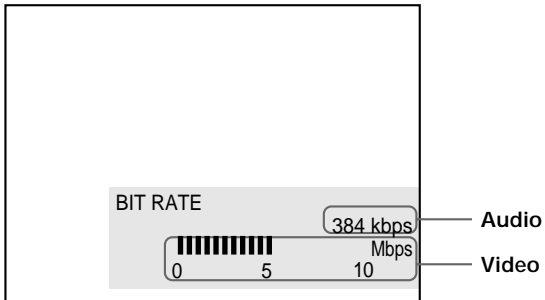

When you play MPEG AUDIO sound tracks

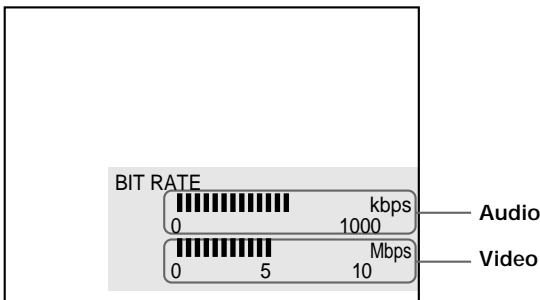

Bit rate refers to the amount of video/audio data per second in a disc. The higher the bit rate is, the larger the amount of data. When the bit rate level is high, there is a large amount of data. However, this does not always mean that you can get higher quality pictures or sounds.

BIT RATE HISTORY

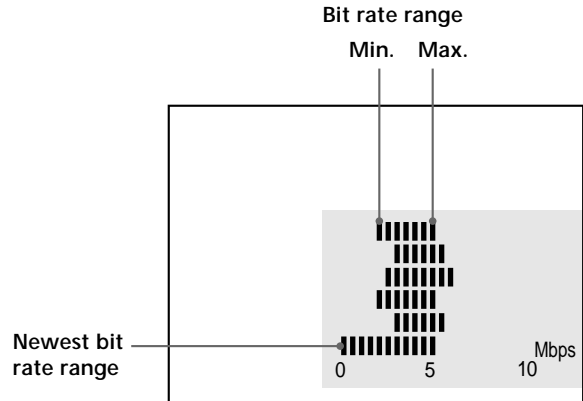

Indicates the transition of bit rate of the playback picture for a period up to the present.

LAYER

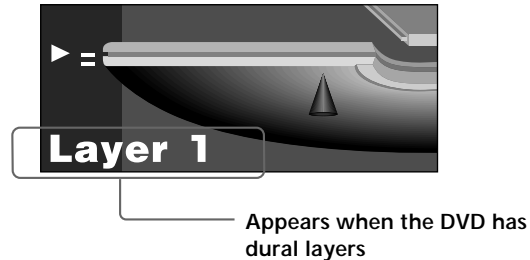

Indicates the approximate point where the disc is playing. If it is a dual-layer DVD, the system indicates which layer is being read.

For details on the layers, see page 62 (DVD).

Settings and Adjustments

This chapter describes how to set and how to adjust using the on-screen SETUP menu. Most settings and adjustments are required to be set when you first use the system.

Using the Setup Display



Using the setup display, you can do the initial setup, adjusting the picture, etc. You can also set a language for the subtitles and the setup display, limit playback by children, etc.

For details on each setup display item, see pages 44 to 50.

Note

You can display the setup display only when the system is in stop mode.

Open the cover.

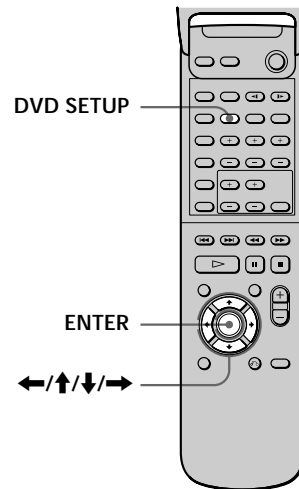

- 1 Press DVD SETUP to display the setup display on the TV screen.

LANGUAGE SETUP	
OSD:	ENGLISH
DVD MENU:	ENGLISH
AUDIO:	ORIGINAL
SUBTITLE:	AUDIO FOLLOW
To set, press [Left] [Up] [Down] [Right], then [ENTER].	
To quit, press [DVD SETUP].	

Continued to the next page

Using the Setup Display

- 2 Select the main item you want using **↑/↓**, and then press **ENTER**.

The selected main item is highlighted.

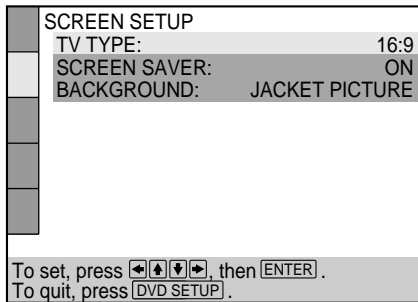
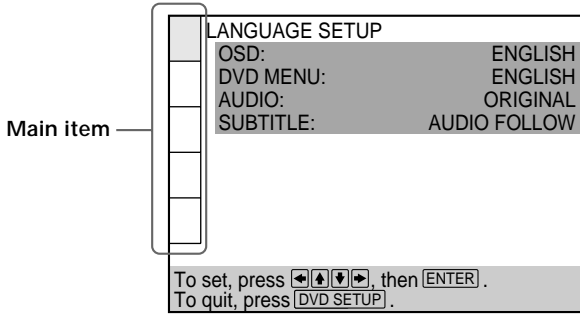

- 3 Select the item you want using **↑/↓**, then press **→** or **ENTER**.

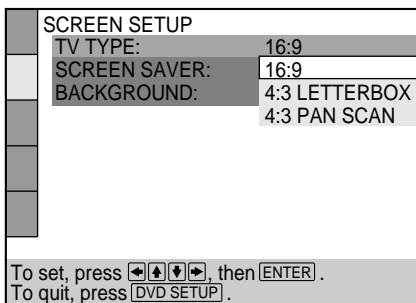
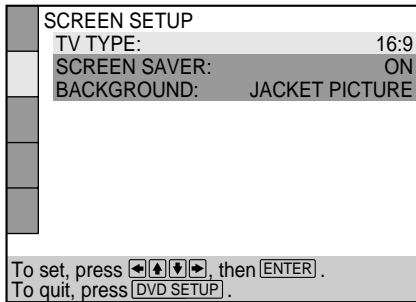

- 4 Select the setting you want using **←/↑/↓/→**, then press **ENTER**.

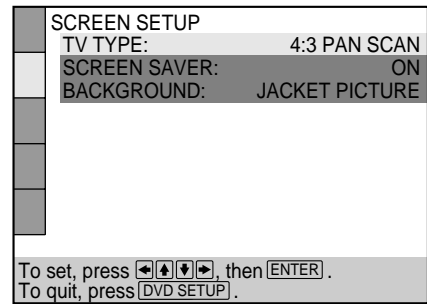
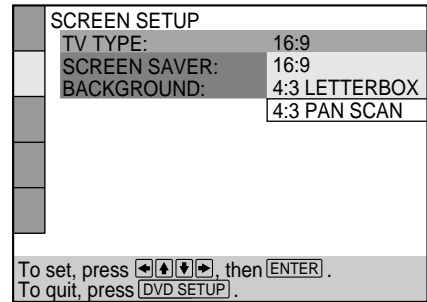

- 5 Press **DVD SETUP** to exit menu.

To cancel using the setup display

Press **DVD SETUP** on the remote.

Note

Some setup display items require operations other than selecting the setting. For details on these items, see the relevant pages.

Setup Display Item List

The default settings are underlined.

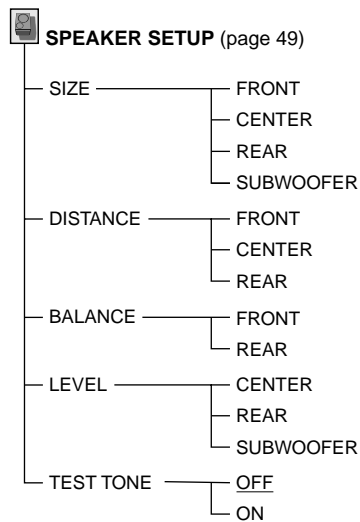
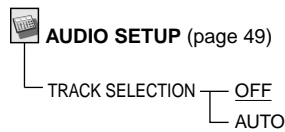
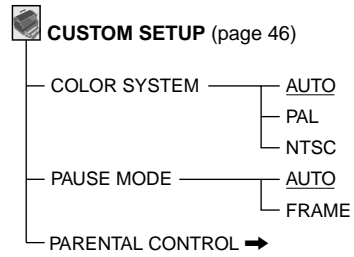
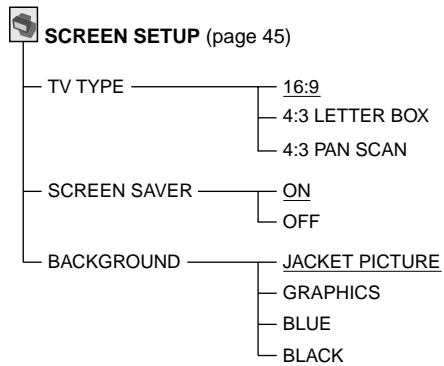
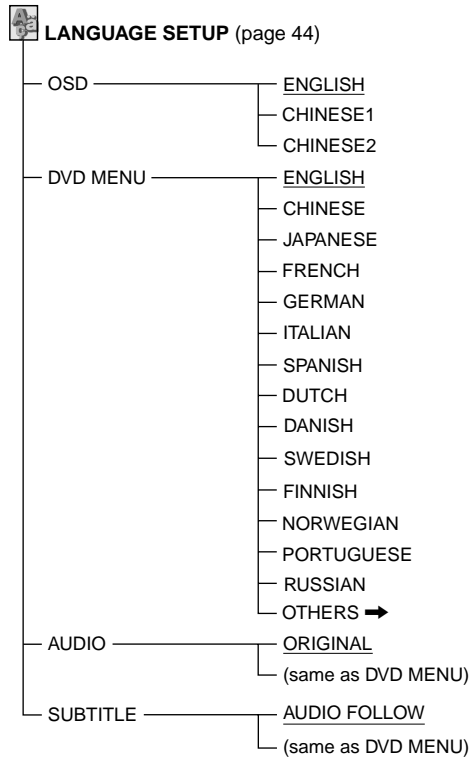

Setting the Language for Display and Sound (LANGUAGE SETUP)

Select "LANGUAGE SETUP" after pressing DVD SETUP. "LANGUAGE SETUP" allows you to set various languages for on-screen display or sound. The default settings are underlined.

Note

When you select a language that is not recorded on the DVD, one of the recorded languages is automatically selected except for the "OSD."

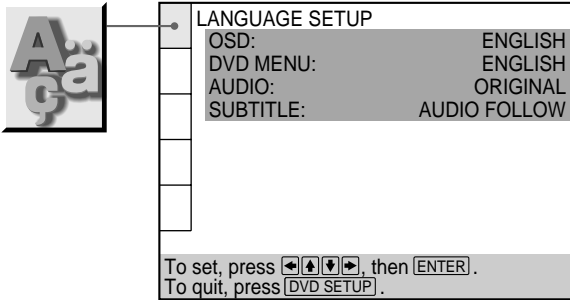

■ OSD (On-Screen Display)

Switches the language for the on-screen display.

- ENGLISH
- CHINESE 1
- CHINESE 2

■ DVD MENU

Switches the language for the DVD menu.

- ENGLISH
- CHINESE
- JAPANESE
- FRENCH
- GERMAN
- ITALIAN
- SPANISH
- DUTCH
- DANISH
- SWEDISH
- FINNISH
- NORWEGIAN
- PORTUGUESE
- RUSSIAN
- OTHERS ➔

When you select "OTHERS ➔," select and enter the language code from the list using the number buttons (page 63).

After you have once selected, the language code (4 digits) is displayed.

■ AUDIO

Switches the language for the sounds.

- ORIGINAL: the language given priority in the disc
- ENGLISH
- CHINESE
- JAPANESE
- FRENCH
- GERMAN
- ITALIAN
- SPANISH
- DUTCH
- DANISH
- SWEDISH
- FINNISH
- NORWEGIAN
- PORTUGUESE
- RUSSIAN
- OTHERS ➔

When you select "OTHERS ➔," select and enter the language code from the list using the number buttons (page 63).

After you have once selected, the language code (4 digits) is displayed.

■ SUBTITLE

Switches the language for the subtitles.

- AUDIO FOLLOW*
- ENGLISH
- CHINESE
- JAPANESE
- FRENCH
- GERMAN
- ITALIAN
- SPANISH
- DUTCH
- DANISH
- SWEDISH
- FINNISH
- NORWEGIAN
- PORTUGUESE
- RUSSIAN
- OTHERS ➔

When you select "OTHERS ➔," select and enter the language code from the list using the number buttons (page 63).

After you have once selected, the language code (4 digits) is displayed.

* When you select "AUDIO FOLLOW," the language for the subtitles changes according to the language for the setting you selected in "AUDIO."

Settings for Display (SCREEN SETUP)

Select "SCREEN SETUP" after pressing DVD SETUP.
"SCREEN SETUP" allows you to set the display according to the playback conditions.
The default settings are underlined.

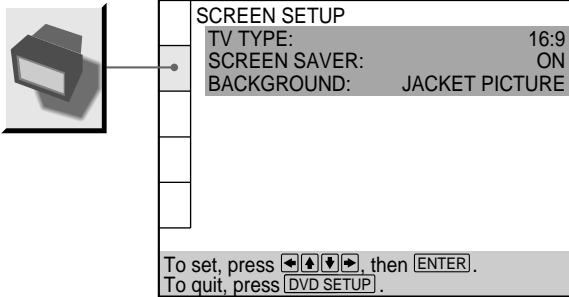

■TV TYPE

Selects the aspect ratio of the TV to be connected.

- 16:9: when you connect a wide-screen TV to the system.
- 4:3 LETTER BOX: when you connect a normal TV to the system. Displays a wide picture with bands displayed on the upper and lower portions of the screen.
- 4:3 PAN SCAN: when you connect a normal TV to the system. Displays the wide picture on the whole screen with a portion automatically cut off.

16:9

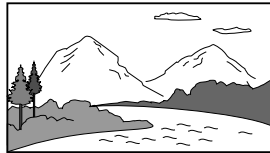

4:3 LETTER BOX



4:3 PAN SCAN

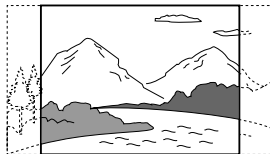

Note

Depending on the DVD, "4:3 LETTER BOX" may be selected automatically instead of "4:3 PAN SCAN" and vice versa.

■SCREEN SAVER

Turns on and off the screen saver. If you turn on the screen saver, the screen saver image appears when you leave the system or the remote in pause or stop mode for 15 minutes or when you play back a CD for more than 15 minutes. The screen saver is useful to prevent your display from becoming damaged.

- ON: turns on the screen saver.
- OFF: turns off the screen saver.

■BACKGROUND

Selects the background color or picture of the TV screen in stop mode or while playing a CD.

- JACKET PICTURE: The jacket picture appears in the background, but only when the jacket picture is already recorded on the disc.
- GRAPHICS: The graphic picture stored in memory in the system beforehand appears in the background.
- BLUE: The background color is blue.
- BLACK: The background color is black.

Note

If a disc which does not contain the jacket picture is played while "BACKGROUND" is set to "JACKET PICTURE," the graphic picture stored in the system will automatically appear in the background.

Custom Settings (CUSTOM SETUP)

Select "CUSTOM SETUP" after pressing DVD SETUP. "CUSTOM SETUP" allows you to set the playback conditions.

The default settings are underlined.

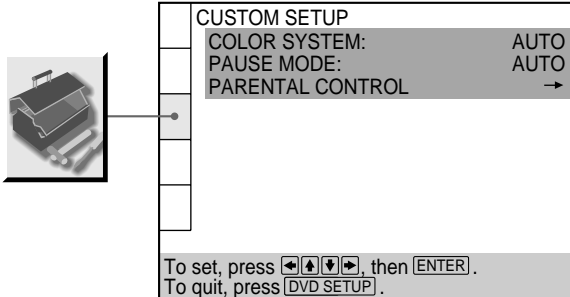

■ COLOR SYSTEM

Selects the color system when you play a VIDEO CD.

- AUTO: outputs the video signal in the color system of the VIDEO CD, either PAL or NTSC. If your TV is the DUAL system, select AUTO.
- PAL: changes the video signal of an NTSC VIDEO CD and outputs it in PAL system.
- NTSC: changes the video signal of a PAL VIDEO CD and outputs it in NTSC system.

Notes

- You cannot change the color system of the DVD.
- You can change the color system of this system according to the connected TV. See page 11.

■ PAUSE MODE

Selects the picture in pause mode.

- AUTO: A picture including subjects that move dynamically is output with no jitter. Normally select this position.
- FRAME: A picture including subjects that do not move dynamically is output with high resolution.

■ PARENTAL CONTROL →

Sets a password and playback limitation level when you play DVDs with playback limitation for children. For details, see "Limiting Playback by Children (Parental Control) ."

Limiting Playback by Children (Parental Control)

Select "CUSTOM SETUP" after pressing DVD SETUP. Playing some DVDs can be limited depending on the age of users. The "Parental Control" function allows you to set a playback limitation level.

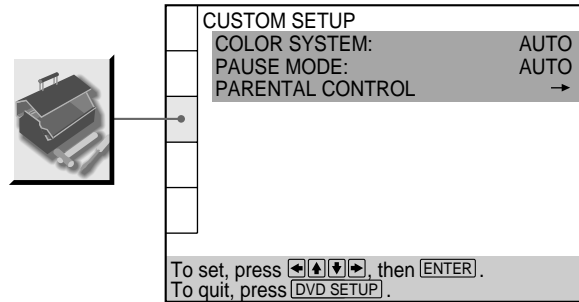

- 1 Select "PARENTAL CONTROL" using ↑/↓, then press ENTER.

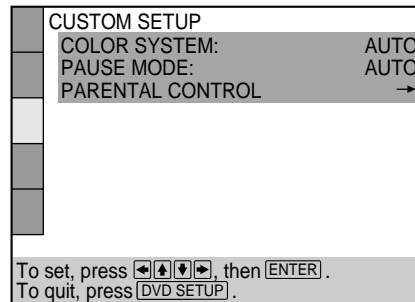

- When you have not entered a password yet
The display for entering a password appears.

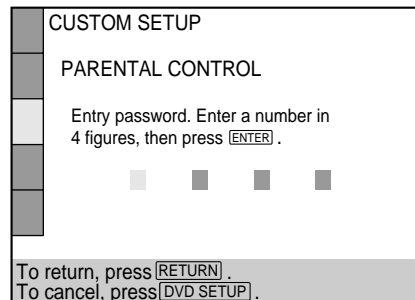

- **When you have already entered a password**
The display for confirming the password appears.
Skip Step 2.

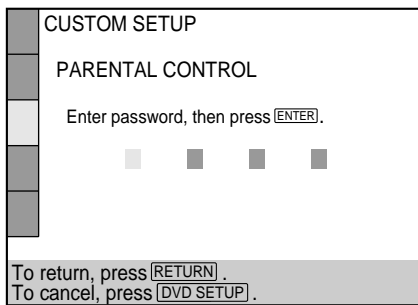

- 2** Enter a password in 4 digits using the number buttons, then press ENTER.
The digits change to asterisks (*), and the display for confirming the password appears.

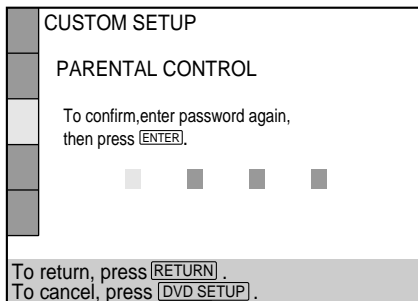

- 3** To confirm your password, enter it using the number buttons, then press ENTER.
The display for setting the playback limitation level and changing the password appears.

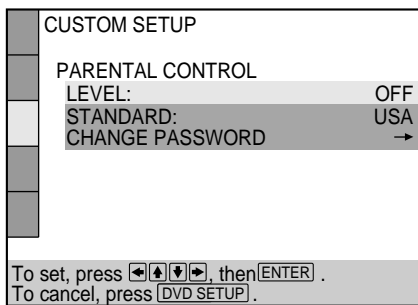

- 4** Select "STANDARD" using ↑/↓, then press →.

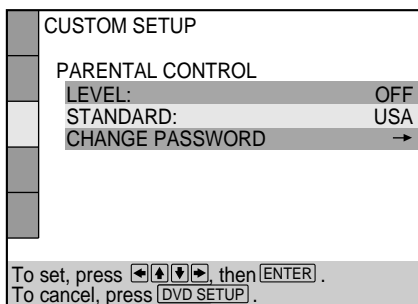

- 5** Select an area as the standard for playback limitation level using ↑/↓, then press →.
When you select "OTHERS →", select and enter the standard code in the table below using the number buttons.

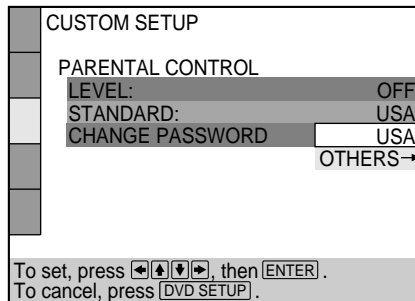

- 6** Select "LEVEL" using ↑/↓, then press →.

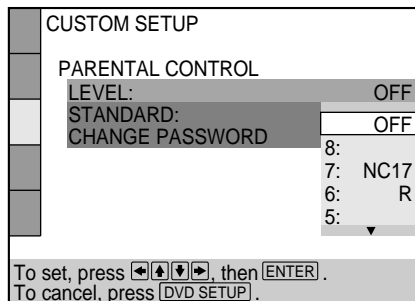

- 7** Select the level you want using ↑/↓, then press ENTER.

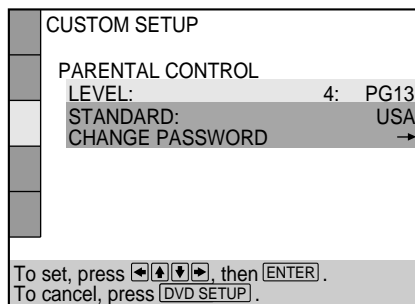

The lower the value is, the more strict the limitation.

Custom Settings (CUSTOM SETUP)

To return to the normal screen

Press DVD SETUP.

To turn off the Parental Control function and play the DVD after entering your password

Set "LEVEL" to "OFF" in Step 7, then press \triangleright .

To change the password

1 After Step 3, select "CHANGE PASSWORD" using \uparrow/\downarrow , then press \rightarrow or ENTER.

The display for changing the password appears.

2 Follow Steps 2 and 3 to enter a new password.

 You can turn off the Parental Control function just after inserting the DVD (Parental Control Temporarily Canceled) When you set a playback limitation level and insert the DVD, the PARENTAL CONTROL display appears. Enter the password to turn off the Parental Control function. When you stop playing the DVD, the level returns to the original level.

If you have forgot your password

Enter the 6 digits number "199703" in Step 2 to clear the current password. To enter a new password, follow the procedure from Step 2 again.

Notes

- When you play DVDs which do not have the Parental Control function, playback cannot be limited on this system.
- When you do not set a password, you cannot change the settings for playback limitation.
- Depending on the DVD, you may be asked to change the parental control level while playing the disc. In this case, enter the password, then change the level. When you stop playing the DVD, the level returns to the original level.

Standard	Code number
Austria	2046
Belgium	2057
Canada	2079
China	2092
Denmark	2115
Finland	2165
France	2174
Germany	2109
Hong Kong	2219
Indonesia	2238
Italy	2254
Japan	2276
Malaysia	2363
Netherlands	2376
Norway	2379
Philippines	2424
Russian	2489
Singapore	2501
Spain	2149
Sweden	2499
Switzerland	2086
Taiwan	2543
Thailand	2528
United Kingdom	2184

Settings for Sound (AUDIO SETUP)

Select "AUDIO SETUP" after pressing DVD SETUP. "AUDIO SETUP" allows you to select the sound track. The default settings are underlined.

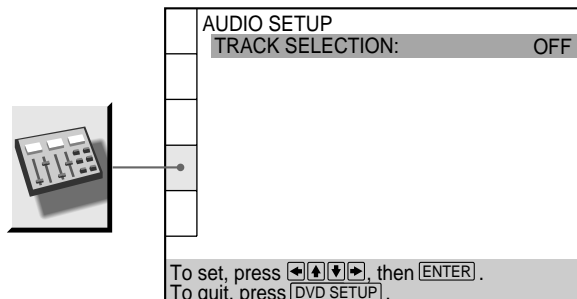

■ TRACK SELECTION

Gives the sound track which contains the highest number of the channels priority when you play a DVD on which multiple audio formats are recorded. If multiple audio channels are recorded in PCM, DTS, MPEG AUDIO or Dolby Digital format, the higher-numbered channel audio recorded in PCM, DTS, MPEG AUDIO or Dolby Digital format is played.

- OFF : No priority given.
- AUTO : Priority given.

Notes

- When you set this item to "AUTO," the language may change depending on the "AUDIO" settings in "LANGUAGE SETUP." The "TRACK SELECTION" setting has higher priority than that of "AUDIO" settings in "LANGUAGE SETUP" (page 44).
- If PCM, DTS, MPEG AUDIO and Dolby Digital sound tracks have the same number of the highest channels, the system selects PCM, DTS, Dolby Digital and MPEG AUDIO sound tracks, in this order.
- Depending on the DVD, the audio with priority may be predetermined. In this case, you cannot give priority to the DTS, MPEG AUDIO or Dolby Digital format by selecting "AUTO."

Settings for Speakers (SPEAKER SETUP)

Select "SPEAKER SETUP" after pressing DVD SETUP. To obtain the best possible surround sound, first specify the distance of the speakers from your listening position, then set the balance and level. Then use the test tone to adjust the speaker volumes to the same level.

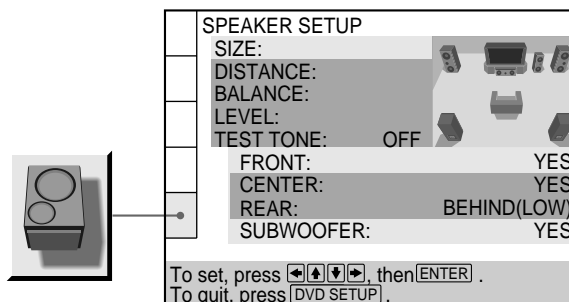

■ SIZE

When you do not connect center or rear speakers, or move the rear speakers, set the parameters for CENTER and REAR. Since the front speaker and subwoofer settings are fixed, you cannot change them. The default settings are underlined.

- FRONT
- YES
- CENTER
- YES: Normally select this.
- NONE: If you will not connect a center speaker, select this.
- REAR
- BEHIND (LOW), BEHIND (HIGH), SIDE (LOW), SIDE (HIGH): Specify the position and height to implement the Digital Cinema Surround modes in the "Virtual Multi Dimension" sound field (p. 20) properly.
- NONE: If you will not connect a rear speaker, select this.
- SUBWOOFER
- YES

Notes

- When you select an item, the sound cuts off for a moment.
- Depending on the settings of other speakers, the subwoofer may output excessive sound.

Settings for Speakers (SPEAKER SETUP)

Specifying the rear speaker position and height

If you select other than "NONE" in "REAR," specify the position and height of the rear speakers, referring to the diagram on page 15. The default setting is underlined.

- BEHIND (LOW)
Select this if the rear speakers are located in the section **B** and **D**.
- BEHIND (HIGH)
Select this if the rear speakers are located in the section **B** and **C**.
- SIDE (LOW)
Select this if the rear speakers are located in the section **A** and **D**.
- SIDE (HIGH)
Select this if the rear speakers are located in the section **A** and **C**.

These parameters are not available when "REAR" is set to "NONE".

■DISTANCE

You can vary the distance of each speaker as follows. The default adjustments are in the parentheses.

- FRONT (5m)
Front speaker distance can be set in 0.2 meter steps from 1.0 to 15.0 meters.
- CENTER (5m)
Center speaker distance can be set in 0.2 meter steps from a distance equal to the front speaker distance to a distance 1.6 meters closer to your listening position.
- REAR (3.4m)
Rear speaker distance can be set in 0.2 meter steps from a distance equal to the front speaker distance to a distance 4.6 meters closer to your listening position.

Notes

- When you set the distance, the sound cuts off for a moment.
- If each of the front or rear speakers are not placed an equal distance from your listening position, set the distance of the closest speaker.

■BALANCE

You can vary the balance of each speaker as follows. The default adjustments are in the parentheses.

- FRONT (center)
Adjust the balance between the front left and right speakers (6 dB (L) to 6 dB (R), 1 dB steps).
- REAR (center)
Adjust the balance between the rear left and right speakers (6 dB (L) to 6 dB (R), 1 dB steps).

■LEVEL

You can vary the level of each speaker as follows. The default adjustments are in the parentheses.

- CENTER (0 dB)
Adjust the level of the center speaker (-6 dB to +6 dB, 1 dB steps).
- REAR (0 dB)
Adjust the level of the rear speakers (-6 dB to +6 dB, 1 dB steps).
- SUBWOOFER (0 dB)
Adjust the level of the subwoofer (-6 dB to +6 dB, 1 dB steps).

■TEST TONE

You can hear the test tone from each speaker in sequence. The default setting is underlined.

- OFF: The test tone is not emitted from speakers.
- ON: During adjustment of "BALANCE" or "LEVEL," the test tone is emitted from both speakers simultaneously.

To adjust the volume of all the speakers at one time

Use the VOLUME control.

To return to the default setting

Select the item, then press CLEAR.

Adjusting the speaker volume

- 1 When nothing is played, select "SPEAKER SETUP" after pressing DVD SETUP.
- 2 Select "TEST TONE" and set "TEST TONE" to "ON." You will hear the test tone from each speaker in sequence.
- 3 From your listening position, select "BALANCE" or "LEVEL" and adjust the value of "BALANCE" and "LEVEL" using \uparrow/\downarrow .
During this adjustment, the test tone is emitted from both speakers simultaneously.
- 4 Select "TEST TONE" and set "TEST TONE" to "OFF" to turn off the test tone.

Other Operations

This chapter describes how to set the remote for controlling the TV, listen to the radio, etc.

Controlling the TV with the Supplied Remote

If you adjust the remote signal, you can control your TV with the supplied remote. Default setting is to control Sony TVs with the  mark.

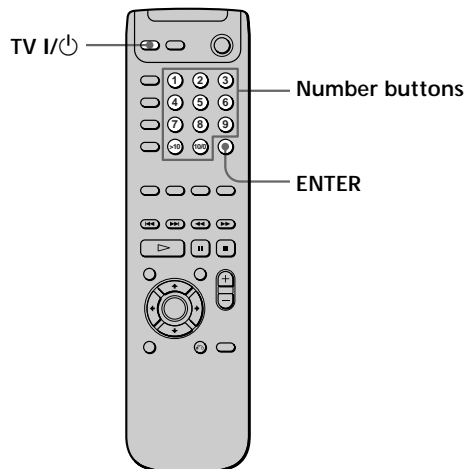

Controlling TVs with the remote

- 1 While holding down TV I/⏻,
 - ① Enter your TV's manufacturer's code (see the table on the next page) using the number buttons.
 - ② Press ENTER.
- 2 Release TV I/⏻.

Code numbers of controllable TVs

If more than one code number is listed, try entering them one at a time until you find the one that works with your TV.

Notes

- If you enter a new code number, the code number previously entered will be erased.
- When you replace the batteries of the remote, the code number may reset to 01 (Sony). Reset the appropriate code number.

Controlling the TV with the Supplied Remote

To control a TV

Make	Code(s)
DAEWOO	02, 04, 05, 06, 07, 15
FISHER	08
GOLDSTAR (LG)	02, 03, 11, 12, 15, 34
GRUNDIG	17, 34
HITACHI	02, 13, 14, 15
ITT/NOKIA	21, 22
JVC	16
MAGNAVOX	02, 03, 18
MITSUBISHI/MGA	02, 03, 19
NEC	02, 03, 20
PANASONIC	09, 24
PHILIPS	15, 18
PIONEER	09, 25, 26, 40
RCA/PROSCAN	02, 10, 27, 28, 29
SAMSUNG	02, 03, 15, 31, 32, 33, 34
SANYO	08
SHARP	35
SONY	01
TELEFUNKEN	23, 36, 37, 38
THOMSON	30, 37, 39
TOSHIBA	35, 40, 41
ZENITH	42, 43

You can control your TV using the buttons below.

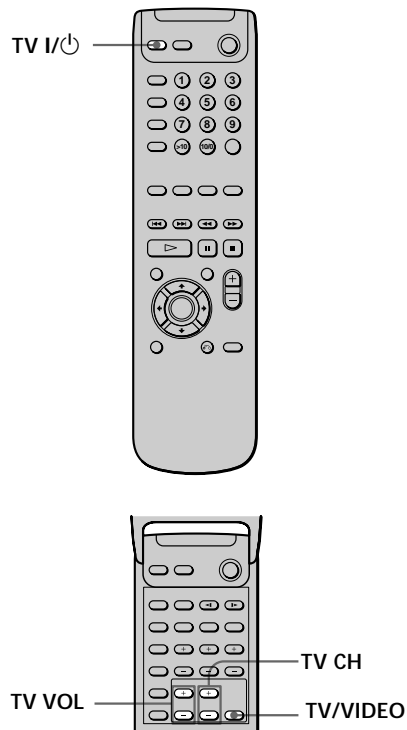

By pressing	You can
TV I/Power	Turn the TV on or off
TV/VIDEO	Select the input source for the TV
TV VOL	Adjust the volume of the TV
TV CH	Change the program position of the TV

Note

Depending on the TV, you may not be able to control your TV or to use some of the buttons above.

Listening to the Radio

Preset radio stations in the system's memory first (see "Presetting Radio Stations" on page 17).

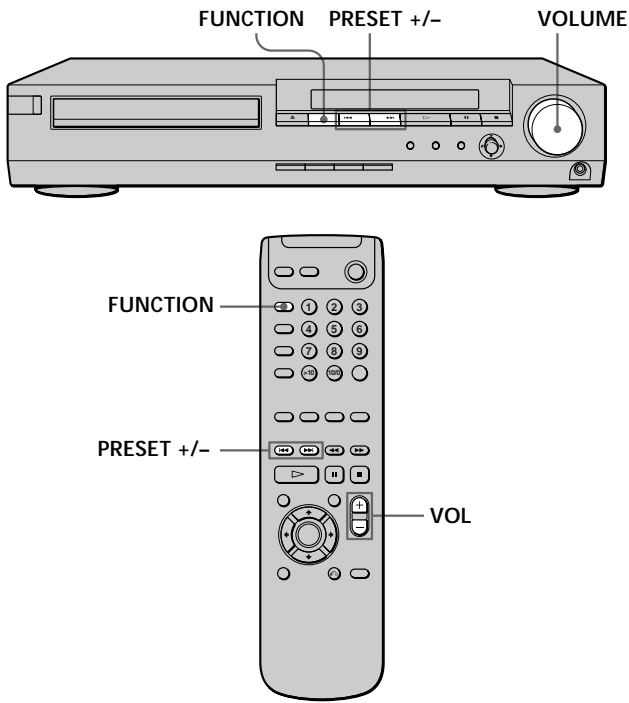

To listen to non-preset radio stations

Use manual or automatic tuning in Step 2.

For manual tuning, press ◀◀ or ▶▶ (TUNING + or -) on the remote repeatedly.

For automatic tuning, press and hold ◀◀ or ▶▶ (TUNING + or -) on the remote.

💡 If an FM program is noisy

Press MONO/STEREO on the remote so that "MONO" appears on the front panel display. There will be no stereo effect, but the reception will improve. Press the button again to restore the stereo effect.

💡 To improve reception

Reorient the supplied antennas.

To check the frequency or sound field

Press DISPLAY repeatedly.

Each time you press DISPLAY, the front panel display changes:

index name of the station → frequency → sound field → index name of the station

- 1 Press FUNCTION repeatedly until "TUNER" appears on the front panel display.

The last received station is tuned in.

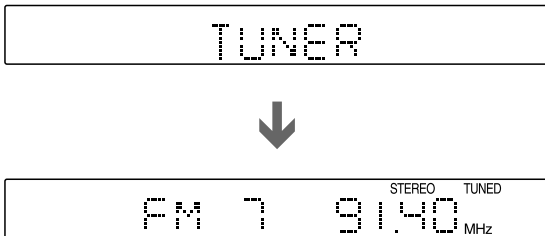

- 2 Press PRESET + or PRESET - repeatedly to select the preset station you want.

Each time you press the button, the system tunes in one preset station at a time.

- 3 Adjust the volume by rotating VOLUME.

To turn off the radio

Press I/⏻.

Naming Preset Stations

You can enter a name of up to 7 characters for preset stations. These names (for example, “XYZ”) appear in the system’s front panel display when a station is selected. Note that no more than one name can be entered for each preset station.

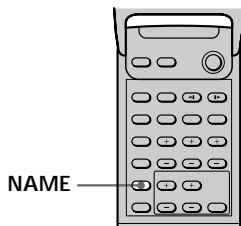
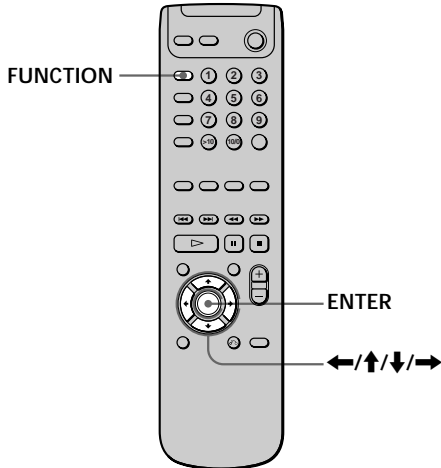

- 1** Press **FUNCTION** repeatedly until “TUNER” appears on the front panel display.

The last station you received is tuned in.
Each time you press **FUNCTION**, the mode of the system changes in the following sequence.
DVD → VIDEO 1 → VIDEO 2 → TUNER → DVD...

- 2** Tune in the preset station you want to create an index name for.

If you are not familiar with how to tune in preset stations, see “Listening to the Radio” on page 53.

- 3** Press **NAME**.

- 4** Create an index name by using the cursor buttons:
Press **↑/↓** to select a character, then press **→** to move the cursor to the next position.

If you’ve made a mistake

Press **←** or **→** repeatedly until the character to be changed flashes, then press **↑/↓** to select the right character.

- 5** Press **ENTER**.

To assign index names to other stations

Repeat Steps 2 to 5.

Using the Sleep Timer

You can set the system to turn off automatically at a specified time.

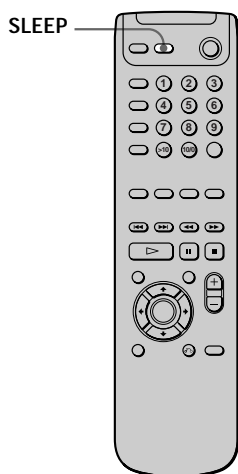

Press **SLEEP** on the remote while the power is on. Each time you press **SLEEP**, the time changes as shown below.

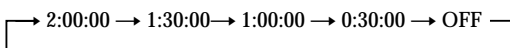
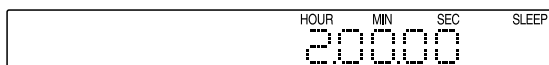

The display dims after you have specified the time.

 You can check the time remaining before the system turns off
Press **SLEEP** on the remote. The remaining time appears on the front panel display.

 You can extend the sleep timer up to 9 hours
Press **↑** on the remote while the time indication is flashing. Each time you press **↑**, the time is extended by 30 minutes up to 9 hours.
When you press **↓**, it is shortened by 30 minutes.

Additional Information

Troubleshooting

If you experience any of the following difficulties while using the system, use this troubleshooting guide to help you remedy the problem. Should any problem persist, consult your nearest Sony dealer.

Power

The power is not turned on.

- ➔ Check that the AC power cord is connected securely.

Picture

There is no picture.

- ➔ Check that the system is connected securely.
- ➔ The video connecting cord is damaged. Replace it with a new one.
- ➔ Make sure you connect the system to the video input connector on the TV (page 11).
- ➔ Make sure you turn on the TV.
- ➔ Make sure you select the video input on the TV so that you can view the pictures from the system.

The picture noise appears.

- ➔ Clean the disc.
- ➔ If video from your system has to go through your VCR to get to your TV, the copy-protection applied to some DVD programs could affect picture quality. If you still experience problems after checking your connections, please try connecting your DVD system directly to your TV's S video-input, if your TV is equipped with this input (page 11).

The aspect ratio of the screen cannot be changed even though you set "TV TYPE" in "SCREEN SETUP" in the setup display when you play a wide picture.

- ➔ The aspect ratio is fixed on your DVD.
- ➔ If you connect the system with the S video cable, connect directly to the TV. Otherwise, you may not change the aspect ratio.
- ➔ Depending on the TV, you may not change the aspect ratio.

Sound

There's no sound or only a very low-level sound is heard.

- ➔ Check that the speakers and components are connected securely.
- ➔ Make sure that you've selected the correct component on the system.

- ➔ Press **MUTING** on the remote if “**MUTING ON**” is displayed on the front panel display.
- ➔ The protective device on the system has been activated because of a short circuit. Turn off the system, eliminate the short-circuit problem and turn on the power again.
- ➔ The audio connecting cord is damaged. Replace it with a new one.
- ➔ The system is in pause mode or in Slow-motion Play mode. Press \triangleright to return to normal play mode.
- ➔ Fast forward or fast reverse is performed. Press \triangleright to return to normal play mode.
- ➔ Check the speaker settings (page 14).

The left and right sounds are unbalanced or reversed.

- ➔ Check that the speakers and components are connected correctly and securely.
- ➔ Adjust front balance parameter in the **LEVEL** menu (page 14).

Severe hum or noise is heard.

- ➔ Check that the speakers and components are connected securely.
- ➔ Check that the connecting cords are away from a transformer or motor, and at least 3 meters away from a TV set or fluorescent light.
- ➔ Move your TV away from the audio components.
- ➔ The plugs and jacks are dirty. Wipe them with a cloth slightly moistened with alcohol.
- ➔ Clean the disc.

The sound loses stereo effect when you play a VIDEO CD or a CD.

- ➔ Set “**AUDIO**” to “**STEREO**” in the Control Menu display (page 35).
- ➔ Make sure you connect the system appropriately.

The surround effect is difficult to hear when you are playing a Dolby Digital sound track.

- ➔ Make sure the sound field function is on (page 20).
- ➔ Check the speaker connections and settings (pages 8, 14).
- ➔ Depending on the DVD, the output signal may not be the entire 5.1 channel but monaural or stereo even if the sound track is recorded in Dolby Digital format.

The sound comes from the center speaker only.

- ➔ Depending on the disc, the sound may come from the center speaker only.

No sound is heard from the center speaker.

- ➔ Make sure the sound field function is on (page 20).
- ➔ Select a sound field containing the word “cinema” or “virtual” (page 20).
- ➔ Adjust the speaker volume (page 14).

No sound or only a very low-level sound is heard from the rear speakers.

- ➔ Make sure the sound field function is on (page 20).
- ➔ Select a sound field containing the word “cinema” or “virtual” (page 20).
- ➔ Adjust the speaker volume (page 14).

Operation

Recording cannot be done.

- ➔ Check that the components are connected correctly.
- ➔ Select the source with a **FUNCTION** button.

Radio stations cannot be tuned in.

- ➔ Check that the antennas are connected securely. Adjust the antennas and connect an external antenna if necessary.
- ➔ The signal strength of the stations is too weak (when tuning in with automatic tuning). Use direct tuning.
- ➔ No stations have been preset or the preset stations have been cleared (when tuning by scanning preset stations). Preset the stations (page 17).
- ➔ Press **DISPLAY** so that the frequency appears in the display.

The remote does not function.

- ➔ Remove any obstacles between the remote and the system.
- ➔ Use the remote near the system.
- ➔ Point the remote at the remote sensor \blacksquare on the system.
- ➔ Replace all the batteries in the remote with new ones if they are weak.

The disc does not play.

- ➔ There is no disc inside (“Insert disc.” appears on the TV screen). Insert a disc.
- ➔ Insert the disc correctly with the playback side facing down on the disc tray.
- ➔ Clean the disc.
- ➔ The system cannot play CD-ROMs, etc. (page 5). Insert a DVD, a VIDEO CD, or a CD.
- ➔ Check the region code of the DVD (page 4).
- ➔ Moisture has condensed inside the system. Remove the disc and leave the system turned on for about half an hour (page 6).

Troubleshooting

The system does not play from the beginning when playing a disc.

- ➔ Repeat Play, Shuffle Play or Program Play has been selected. Press CLEAR.
- ➔ Resume Play has been selected. Press ■ on the front panel or on the remote before you start playing (page 23).
- ➔ A title menu or a DVD menu automatically appears on the TV screen when you play your DVD, or a setup display automatically appears on the TV screen when you play your VIDEO CD with PBC functions.

The system starts playing the DVD automatically.

- ➔ The DVD features the auto playback function.

Playback stops automatically.

- ➔ Depending on the disc, the auto pause signal is recorded. While playing such a disc, the system stops playback at the signal.

Stopping playback, Search, Slow-motion Play, Repeat Play, Shuffle Play or Program Play, etc., cannot be done.

- ➔ Depending on the disc, you may not do some of the operations above.

Messages do not appear on the TV screen in the language you want.

- ➔ In the setup display, select the language for the on-screen display in "OSD" under "LANGUAGE SETUP" (page 44).

The language for the sound cannot be changed when you play a DVD.

- ➔ Multilingual sound is not recorded on the DVD.
- ➔ Changing the language for the sound is prohibited on the DVD.

The language for the subtitles cannot be changed when you play a DVD.

- ➔ Multilingual subtitles are not recorded on the DVD.
- ➔ Changing the language for the subtitles is prohibited on the DVD.

The subtitles cannot be turned off when you play a DVD.

- ➔ Depending on the DVD, you may not be able to turn the subtitles off.

The angles cannot be changed when you play a DVD.

- ➔ Multi-angles are not recorded on the DVD.
- ➔ Change the angles when "ANGLE" appears on the front panel display (page 37).
- ➔ Changing the angles is prohibited on the DVD.

The system does not operate properly.

- ➔ Static electricity, etc., may affect the system's operation. Disconnect the AC power cord once, then connect it again.

Nothing is displayed on the front panel display.

- ➔ Press DIMMER on the remote.

The disc tray does not open and "LOCKED" is displayed on the front panel display.

- ➔ Contact your Sony dealer or local authorized Sony service facility.

The numbers or letters of 5 characters are displayed on the front panel display.

- ➔ Self-diagnosis function was activated. See the table in page 59 and treat the system appropriately.

Self-diagnosis Function

When the self-diagnosis function works to prevent the system from malfunctioning, a five-character service number (combination of a letter and digits) flashes on the screen or the front panel display depending on the cause. In this case, check the following table.

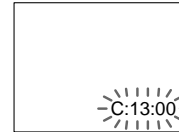

First three characters	Cause and/or Corrective Action
C 13	<ul style="list-style-type: none">• The disc is dirty. ➔ Clean the disc with a cleaning cloth (page 6).
C 31	<ul style="list-style-type: none">• The disc is not inserted correctly. ➔ Open the disc tray and insert the disc correctly.
E xx (xx is any number)	<ul style="list-style-type: none">• To prevent the system from malfunctioning, the self-diagnosis function has worked. ➔ When you contact your Sony dealer or local authorized Sony service facility, give the 5-character service number. (example: E 61 10)

Specifications

Amplifier section

Stereo mode	30 W + 30 W (3 ohms at 1 kHz, THD 10 %)
Surround mode	Front: 30 W + 30 W Center*: 30 W Rear*: 30 W + 30 W (3 ohms at 1 kHz, THD 10 %) Subwoofer*: 30 W (3 ohms at 100 Hz, THD 10 %)

* Depending on the sound field settings and the source, there may be no sound output.

Inputs	VIDEO 1, 2: Sensitivity: 150 mV Impedance: 50 kilohms
Outputs	VIDEO 1 (AUDIO OUT): Voltage: 2 V Impedance: 1 kilohms WOOFER: Voltage: 2 V Impedance: 1 kilohms PHONES: Accepts low- and high-impedance headphones

CD/DVD system

Laser	Semiconductor laser
Signal format system	NTSC/PAL (See page 11 to switch.)
Frequency response (at 2 CH STEREO mode)	DVD (PCM): 2 Hz to 22 kHz (± 1.0 dB) CD: 2 Hz to 20 kHz (± 1.0 dB)
Signal-to-noise ratio	More than 80 dB (VIDEO 1 (AUDIO) connectors only)
Harmonic distortion	Less than 0.03 %

FM tuner section

System	PLL quartz-locked digital synthesizer system
Tuning range	87.50 – 108.00 MHz (50 kHz step)
Antenna	FM wire antenna
Antenna terminals	75 ohms, unbalanced
Intermediate frequency	10.7 MHz

AM tuner section

System	Tuner section: PLL quartz-locked digital synthesizer system
Tuning range	530 – 1710 kHz (10 kHz interval) 531 – 1602 kHz (9 kHz interval)
Antenna	Loop antenna

Video section

Inputs	Video: 1 V _{p-p} 75 ohms
Outputs	Video: 1 V _{p-p} 75 ohms S-video: Y: 1 V _{p-p} 75 ohms C: PAL 0.3 V _{p-p} 75 ohms NTSC 0.286 V _{p-p} 75 ohms

Speakers

SS-TS300 (Front/Center/Rear)

Speaker system	Bass reflex
Speaker unit	70 mm (2 ⁷ / ₈ inches) dia. cone type
Rated impedance	3 ohms
Dimensions (approx.)	97 × 102 × 105 mm (3 ⁷ / ₈ × 4 ¹ / ₈ × 4 ¹ / ₄ inches) (w/h/d)
Mass (approx.)	0.57 kg (1 lb 4 oz)

SS-WS300 (Subwoofer)

Speaker system	Bass reflex
Speaker unit	180 mm (7 ¹ / ₈ inches) dia. cone type
Rated impedance	3 ohms
Dimensions (approx.)	160 × 355 × 355 mm (6 ³ / ₈ × 14 × 14 inches) (w/h/d)
Mass (approx.)	5.41 kg (11 lb 15 oz)

General

Power requirements	110 – 120 V AC, 50/60 Hz
Power consumption	68 W
Dimensions (approx.)	355 × 70 × 365 mm (15 × 2 ⁷ / ₈ × 14 ³ / ₈ inches) (w/h/d) incl. projecting parts
Mass (approx.)	3.8 kg (8 lb 6 oz)
Operating temperature	5°C to 35°C (41°F to 95°F)
Operating humidity	5 % to 90 %
Supplied accessories	See page 7.

Design and specifications are subject to change without notice.

Glossary

Bit rate (page 40)

Value indicating the amount of video data compressed in a DVD per second. The unit is Mbps (Mega bit per second). 1 Mbps indicates that the data per second is 1,000,000 bits. The higher the bit rate is, the larger the amount of data. However, this does not always mean that you can get higher quality pictures.

Chapter

Sections of a picture or a music piece on a DVD that are smaller than titles. A title is composed of several chapters. Each chapter is assigned a chapter number enabling you to locate the chapter you want.

Digital Cinema Sound (DCS)

This is the generic name of the surround sound produced by digital signal processing technology developed by Sony. Unlike previous surround sound fields mainly directed at the reproduction of music, Digital Cinema Sound is designed specifically for the enjoyment of movies.

Dolby Digital

This sound format for movie theaters is more advanced than Dolby Pro Logic Surround. In this format, the rear speakers output stereo sound with an expanded frequency range and a subwoofer channel for deep bass is independently provided. This format is also called “5.1” because the subwoofer channel is counted as 0.1 channel (since it functions only when a deep bass effect is needed). All six channels in this format are recorded separately to realize superior channel separation. Furthermore, since all the signals are processed digitally, less signal degradation occurs. The name “AC-3” comes from the fact that it is the third audio coding method to be developed by the Dolby Laboratories Licensing Corporation.

Dolby Pro Logic Surround

As one method of decoding Dolby Surround, Dolby Pro Logic Surround produces four channels from two-channel sound. Compared with the former Dolby Surround system, Dolby Pro Logic Surround reproduces left-to-right panning more naturally and localizes sounds more precisely. To take full advantage of Dolby Pro Logic Surround, you should have one pair of rear speakers and a center speaker. The rear speakers output monaural sound.

DTS

Digital audio compression technology that the Digital Theater Systems, Inc. developed. This technology conforms to 5.1-channel surround. The rear channel is stereo and there is discrete subwoofer channel in this format. DTS provides the same 5.1 discrete channels of high quality digital audio. The good channel separation is realized because the all channel data is recorded discrete and processed in digital.

DVD

A disc that contains up to 8 hours of moving pictures even though its diameter is the same as a CD.

The data capacity of a single-layer and single-sided DVD, at 4.7 GB (Giga Byte), is 7 times that of a CD.

Furthermore, the data capacity of a dual-layer and single-sided DVD is 8.5 GB, a single-layer and double-sided DVD 9.4 GB, and a dual-layer and double-sided DVD 17 GB.

The picture data uses the MPEG 2 format, one of the worldwide standards of digital compression technology. The picture data is compressed to about 1/40 of its original size. The DVD also uses the variable rate coding technology that changes the data to be allocated according to the status of the picture.

The audio data is recorded in Dolby Digital as well as in PCM, allowing you to enjoy more real audio presence. Furthermore, various advanced functions such as the multi-angle, multilingual, and Parental Control functions are provided with the DVD.

MPEG AUDIO (page 36)

International standard coding system to compress audio digital signals authorized by ISO/IEC. MPEG 1 conforms to up to 2-channel stereo. MPEG 2 used on DVDs conforms to up to 7.1-channel surround.

Multi-angle function (page 37)

Various angles, or viewpoints of the video camera, for a scene are recorded on some DVDs.

Multilingual function (pages 13, 35, 44)

Several languages for the sound or subtitles in a picture are recorded on some DVDs.

Parental Control (page 46)

A function of the DVD to limit playback of the disc by the age of the users according to the limitation level in each country. The limitation varies from disc to disc; when it is activated, playback is completely prohibited, violent scenes are skipped or replaced with other scenes and so on.

Playback Control (PBC) (page 25)

Signals encoded on VIDEO CDs (Version 2.0) to control playback.

By using menu screens recorded on VIDEO CDs with PBC functions, you can enjoy playing simple interactive programs, programs with search functions, and so on.

Title

The longest sections of a picture or a music piece on a DVD; a movie, etc., for a picture piece on video software; or an album, etc., for a music piece on an audio software. Each title is assigned a title number enabling you to locate the title you want.

Track

Sections of a picture or a music piece on a CD or VIDEO CD. Each track is assigned a track number enabling you to locate the track you want.

VIDEO CD

A compact disc that contains moving pictures.

The picture data uses the MPEG 1 format, one of the worldwide standards of digital compression technology.

The picture data is compressed to about 1/140 of its original size. Consequently, a 12 cm VIDEO CD can contain up to 74 minutes of moving pictures.

VIDEO CDs also contain compact audio data. Sounds outside the range of human hearing are compressed while the sounds we can hear are not compressed. VIDEO CDs can hold 6 times the audio information of conventional audio CDs.

There are 2 versions of VIDEO CDs.

- Version 1.1: You can play only moving pictures and sounds.
- Version 2.0: You can play high-resolution still pictures and enjoy PBC functions.

This system conforms to both versions.

Language Code List

For details, see pages 35 and 44.

The language spellings conform to the ISO 639: 1988 (E/F) standard.

Code	Language	Code	Language	Code	Language	Code	Language
1027	Afar	1186	Scots Gaelic	1350	Malayalam	1513	Siswati
1028	Abkhazian	1194	Galician	1352	Mongolian	1514	Sesotho
1032	Afrikaans	1196	Guarani	1353	Moldavian	1515	Sundanese
1039	Amharic	1203	Gujarati	1356	Marathi	1516	Swedish
1044	Arabic	1209	Hausa	1357	Malay	1517	Swahili
1045	Assamese	1217	Hindi	1358	Maltese	1521	Tamil
1051	Aymara	1226	Croatian	1363	Burmese	1525	Telugu
1052	Azerbaijani	1229	Hungarian	1365	Nauru	1527	Tajik
1053	Bashkir	1233	Armenian	1369	Nepali	1528	Thai
1057	Byelorussian	1235	Interlingua	1376	Dutch	1529	Tigrinya
1059	Bulgarian	1239	Interlingue	1379	Norwegian	1531	Turkmen
1060	Bihari	1245	Inupiak	1393	Occitan	1532	Tagalog
1061	Bislama	1248	Indonesian	1403	(Afan) Oromo	1534	Setswana
1066	Bengali; Bangla	1253	Icelandic	1408	Oriya	1535	Tonga
1067	Tibetan	1254	Italian	1417	Punjabi	1538	Turkish
1070	Breton	1257	Hebrew	1428	Polish	1539	Tsonga
1079	Catalan	1261	Japanese	1435	Pashto; Pushto	1540	Tatar
1093	Corsican	1269	Yiddish	1436	Portuguese	1543	Twi
1097	Czech	1283	Javanese	1463	Quechua	1557	Ukrainian
1103	Welsh	1287	Georgian	1481	Rhaeto-Romance	1564	Urdu
1105	Danish	1297	Kazakh	1482	Kirundi	1572	Uzbek
1109	German	1298	Greenlandic	1483	Romanian	1581	Vietnamese
1130	Bhutani	1299	Cambodian	1489	Russian	1587	Volapük
1142	Greek	1300	Kannada	1491	Kinyarwanda	1613	Wolof
1144	English	1301	Korean	1495	Sanskrit	1632	Xhosa
1145	Esperanto	1305	Kashmiri	1498	Sindhi	1665	Yoruba
1149	Spanish	1307	Kurdish	1501	Sangho	1684	Chinese
1150	Estonian	1311	Kirghiz	1502	Serbo-Croatian	1697	Zulu
1151	Basque	1313	Latin	1503	Singhalese	1703	Not specified
1157	Persian	1326	Lingala	1505	Slovak		
1165	Finnish	1327	Laothian	1506	Slovenian		
1166	Fiji	1332	Lithuanian	1507	Samoan		
1171	Faroese	1334	Latvian; Lettish	1508	Shona		
1174	French	1345	Malagasy	1509	Somali		
1181	Frisian	1347	Maori	1511	Albanian		
1183	Irish	1349	Macedonian	1512	Serbian		

Index to Parts and Controls

Refer to the pages indicated in parentheses for details.

Front Panel

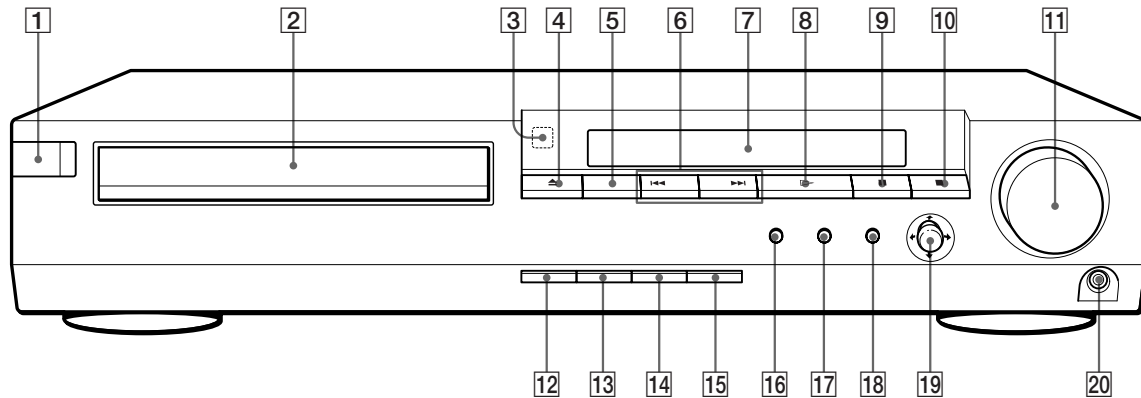

- | | |
|---|--|
| <p>1 I/⏻ (POWER) switch and indicator (18)
Turns on and off the power of the system.</p> <p>2 Disc tray (18)
Place a disc on the tray.</p> <p>3 remote sensor (7)
Accepts the remote control signals.</p> <p>4 OPEN/CLOSE button (18)
Opens or closes the disc tray.</p> <p>5 FUNCTION button (53, 54)
Selects the component you want to use.</p> <p>6 PREV/NEXT/PRESET +/- button
 PREV/NEXT : Press to go to the next chapter or track or to go back to the previous chapter or track (19).
PRESET +/- : Scans all preset stations (17, 53).</p> <p>7 Front Panel Display (28)
Indicates the playing time, etc.</p> <p>8 PLAY button (18)
Plays a disc.</p> <p>9 PAUSE button (19)
Pauses playing a disc.</p> <p>10 STOP button (19, 23)
Stops playing a disc.</p> <p>11 VOLUME control (18)
Adjusts the volume.</p> | <p>12 DISPLAY button (20, 53)
Switches the item displayed on the front panel display.
In the VIDEO 1/2 functions, it switches:
VIDEO 1 (or 2) → Sound field → VIDEO 1 (or 2)</p> <p>13 BAND button (17)
Selects AM or FM band.</p> <p>14 SOUND FIELD button (20)
Selects the sound field.</p> <p>15 MUTING button (19)
Mutes the sound.</p> <p>16 TITLE button (24)
Displays the title menu on the TV screen.</p> <p>17 DVD MENU button (24)
Displays the DVD menu on the TV screen.</p> <p>18 RETURN button (25, 31)
Press to return to the previously selected screen, etc.</p> <p>19 PUSH ENTER button
Selects and executes the items or settings.</p> <p>20 PHONES connector (18)
Connect the headphones to this connector.</p> |
|---|--|

Rear Panel

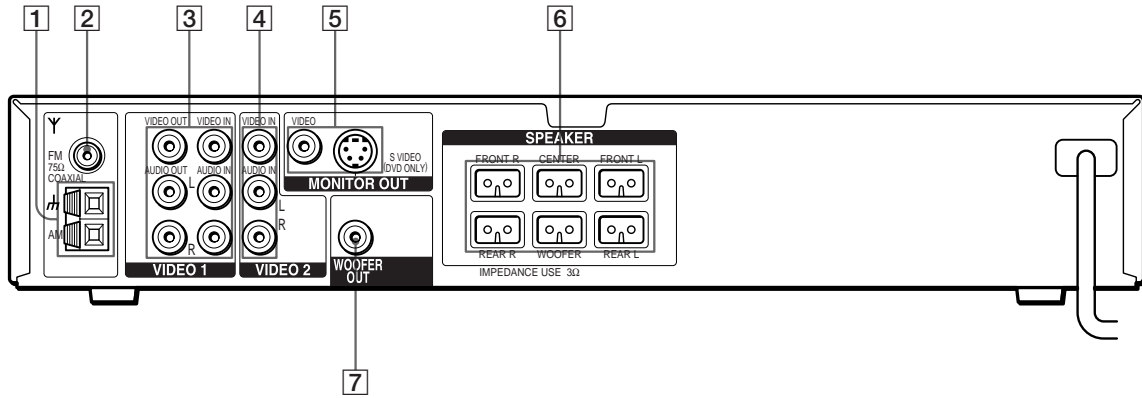

- 1** AM antenna connector (10)
Connects to the supplied AM loop antenna.
- 2** FM 75 Ω COAXIAL antenna connector (10)
Connects to the supplied FM wire antenna.
- 3** VIDEO 1 connectors (11)
Connect to a VCR.
- 4** VIDEO 2 connectors (11)
Connect to an additional VCR.
- 5** MONITOR OUT (VIDEO/S VIDEO) connectors (11)
Connect to a TV monitor.
- 6** SPEAKER connectors (8)
Connect to the supplied speakers.
- 7** WOOFER OUT connector (9)
Connects to a subwoofer of active type.

Remote

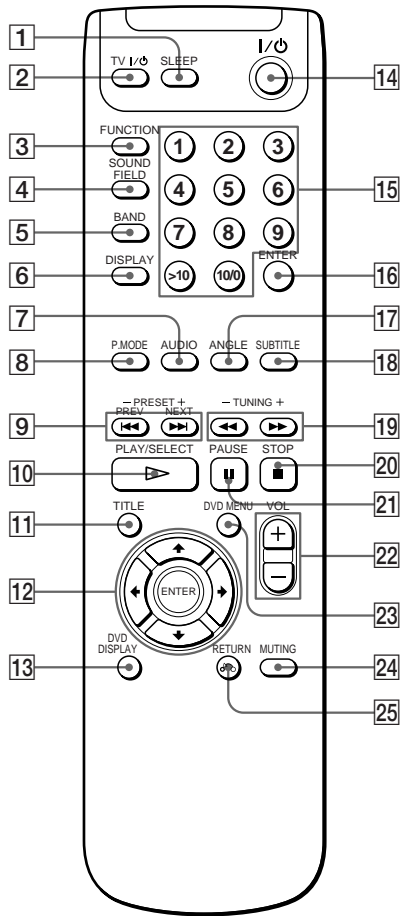

Additional Information

- 1 **SLEEP button (55)**
Activates the sleep timer.
- 2 **TV I/⏻ (POWER) switch (52)**
Turns the TV on and off.
- 3 **FUNCTION button (53, 54)**
Selects the component you want to use.
- 4 **SOUND FIELD button (20)**
Selects the sound field.
- 5 **BAND button (17)**
Selects AM or FM band.
- 6 **DISPLAY button (20, 53)**
Switches the item displayed on the front panel display.
In the VIDEO 1/2 functions, it switches:
VIDEO 1 (or 2) → Sound field → VIDEO 1 (or 2)
- 7 **AUDIO button (35)**
Changes the sound while playing a DVD or VIDEO CD.

- 8 **P. MODE button (26, 27)**
Selects program or shuffle play mode.
- 9 **◀◀/▶▶PREV/NEXT/PRESET +/- buttons**
◀◀/▶▶PREV/NEXT : Press to go to the next chapter or track or to go back to the previous chapter or track (19).
PRESET +/- : Scan all preset stations (17, 53).
- 10 **▶PLAY/SELECT button (18)**
Plays a disc.
- 11 **TITLE button (24)**
Displays the title menu on the TV screen.
- 12 **←/↑/↓/→/ENTER button**
Selects and executes the items or settings.
- 13 **DVD DISPLAY button (30)**
Displays the Control Menu display on the TV screen to set or adjust the items.
- 14 **I/⏻ (POWER) switch (18)**
Turns on and off the power of the system.
- 15 **Number buttons**
Select the items or settings.
- 16 **ENTER button**
Executes the items or settings.
- 17 **ANGLE button (37)**
Changes the angles when playing a DVD.
- 18 **SUBTITLE button (36)**
Displays the "SUBTITLE" menu in the Control Menu display.
- 19 **◀◀/▶▶ (SCAN)/TUNING +/- buttons**
◀◀/▶▶ (SCAN) : Locate a point while monitoring the picture (19).
TUNING +/- : Scan all available radio stations (17).
- 20 **■STOP button (19, 23)**
Stops playing a disc.
- 21 **▬PAUSE button (19)**
Pauses playing a disc.
- 22 **VOL (volume) +/- buttons (18)**
Adjust the volume.
- 23 **DVD MENU button (24)**
Displays the DVD menu on the TV screen.
- 24 **MUTING button (19)**
Mutes the sound.
- 25 **↶RETURN button (25, 31)**
Press to return to the previously selected screen, etc.

Remote

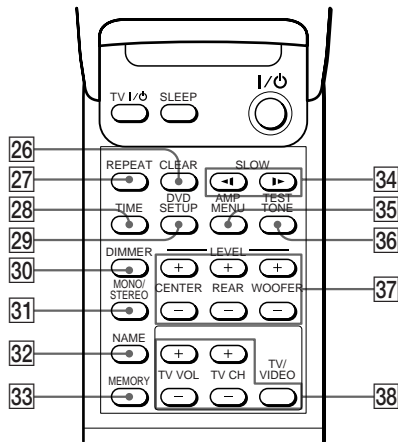

Inside the cover

- 26 CLEAR button**
Press to return to the Continuous play, etc.
- 27 REPEAT button (38)**
Displays the “REPEAT” display on the TV screen.
- 28 TIME button (28)**
Displays the playing time of the disc, etc., on the front panel display.
- 29 DVD SETUP button (41)**
Displays the setup display on the TV screen to set or adjust the items.
- 30 DIMMER button (28)**
Turns the front panel display on or off.
- 31 MONO/STEREO button (53)**
Switches monaural or stereo of FM stereo reception.
- 32 NAME button (54)**
Activates the name function.
- 33 MEMORY button (17)**
Press to store a preset station.
- 34 ◀/▶ SLOW buttons (19)**
Play a disc in slow motion.
- 35 AMP MENU button (14)**
Displays the speaker set up parameters on the front panel display.
- 36 TEST TONE button (14)**
Turns test tone on and off.
- 37 SPEAKER LEVEL +/- buttons (16)**
Press to adjust the speaker level.
- 38 TV operation buttons (52)**
Control TVs.

Index

Numerics

- 4:3 LETTER BOX 45
- 4:3 PAN SCAN 45
- 16:9 45

A

- A-B REPEAT 38
- A↔B Repeat 38
- Angle 37
- ANGLE 37
- AUDIO 35, 44
- AUDIO SETUP 49

B

- BACKGROUND 45
- BALANCE 16, 50
- Batteries 7

C

- CD 18
- Chapter 5, 32
- CHAPTER 32
- Color system 11
- Connecting 8, 10, 11, 12
- Continuous play
 - CD/VIDEO CD 18
 - DVD 18
- Control Menu display 30
- CUSTOM SETUP 46

D, E

- Display
 - Control Menu display 30
 - Front panel display 28
 - Setup display 41
- DISTANCE 15, 50
- Dolby Digital 20, 61
- DTS 49
- DVD 18
- DVD MENU 24, 44

F, G

- Fast Forward 19
- Fast Reverse 19
- Front panel display 28

H

- Handling discs 6
- Hi-speed search 19
- Hooking up 8, 10, 11, 12

I, J, K

- INDEX 32

L, M, N

- LANGUAGE SETUP 44
- LETTER BOX 45
- LEVEL 16, 50
- Locating
 - a specific point 19
- MPEG 62

O

- On-screen display
 - Control Menu display 30
 - Setup display 41
- OSD 44

P, Q

- PAN SCAN 45
- PARENTAL CONTROL 46
- PBC functions 25
- PBC Playback 25, 62
- PRO LOGIC 20, 61
- Program Play 26

R

- Remote 7, 51
- REPEAT 38
- Resume Play 23

S

- S video output 11
- Scene 5
- SCENE 32
- SCREEN SAVER 45
- SCREEN SETUP 45
- Searching 19
- Setup display 41
- Shuffle Play 27
- SIZE 15, 49
- Slow-motion Play 19
- SOUND FIELD
 - customizing 22
 - selecting 20
- SPEAKER SETUP 14, 49
- Speakers
 - hookup 8
 - set up 14
- SUBTITLE 36

T

- TEST TONE 16, 50
- TIME 28, 33, 34
- Title 5, 32, 62
- TITLE 32
- Title menu 24
- Track 5, 32, 62
- TRACK 32
- TRACK SELECTION 49
- Troubleshooting 56
- TV TYPE 45

U

- Usable discs 4

V, W, X, Y, Z

- VIDEO CD 18