

FM Stereo FM-AM Receiver

Operating Instructions

STR-DE675

WARNING

To prevent fire or shock hazard, do not expose the unit to rain or moisture.

To avoid electrical shock, do not open the cabinet. Refer servicing to qualified personnel only.

Do not install the appliance in a confined space, such as a bookcase or built-in cabinet.



Don't throw a battery, dispose it as the injurious wastes.

Precautions

On safety

- Should any solid object or liquid fall into the cabinet, unplug the receiver and have it checked by qualified personnel before operating it any further.
- To prevent fire, do not cover the ventilation of the receiver with newspapers, table cloths, curtains, etc. And don't place lighted candles on the receiver.
- To prevent fire or shock hazards, do not place vases on the receiver.

On power sources

- Before operating the receiver, check that the operating voltage is identical with your local power supply. The operating voltage is indicated on the nameplate at the rear of the receiver.
- The unit is not disconnected from the AC power source (mains) as long as it is connected to the wall outlet, even if the unit itself has been turned off.
- If you are not going to use the receiver for a long time, be sure to disconnect the receiver from the wall outlet. To disconnect the AC power cord, grasp the plug itself; never pull the cord.
- AC power cord must be changed only at the qualified service shop.

On placement

- Place the receiver in a location with adequate ventilation to prevent heat buildup and prolong the life of the receiver.
- Do not place the receiver near heat sources, or in a place subject to direct sunlight, excessive dust or mechanical shock.
- Do not place anything on top of the cabinet that might block the ventilation holes and cause malfunctions.
- Although the receiver heats up during operation, this is not a malfunction. If you continuously use this receiver at a large volume, the cabinet temperature of the top, side and bottom rises accordingly. To avoid burning yourself, do not touch the cabinet.

On operation

Before connecting other components, be sure to turn off and unplug the receiver.

On cleaning

Clean the cabinet, panel and controls with a soft cloth slightly moistened with a mild detergent solution. Do not use any type of abrasive pad, scouring powder or solvent such as alcohol or benzene.

If you have any question or problem concerning your receiver, please consult your nearest Sony dealer.

About This Manual

The instructions in this manual is for model STR-DE675. Check your model number by looking at the lower right corner of the front panel.

About area codes

The area code of the player you purchased is shown on the lower portion of the rear panel (see the illustration below).

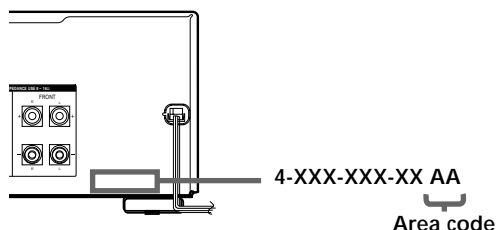

Any differences in operation, according to the area code, are clearly indicated in the text, for example, "Models of area code AA only".

Conventions

- The instructions in this manual describe the controls on the receiver. You can also use the controls on the supplied remote if they have the same or similar names as those on the receiver.
- The following icon is used in this manual:
💡 Indicates hints and tips for making the task easier.

This receiver incorporates Dolby* Digital and Pro Logic Surround and the DTS** Digital Surround System.

- * *Manufactured under license from Dolby Laboratories. "Dolby", "Pro Logic" and the double-D symbol $\square\square$ are trademarks of Dolby Laboratories. Confidential unpublished Works. © 1992-1997 Dolby Laboratories. All rights reserved.*
- ***Manufactured under license from Digital Theater Systems, Inc. US Pat. No. 5,451,942, 5,956,674, 5,974,380, 5,978,762 and other world-wide patents issued and pending. "DTS" and "DTS Digital Surround" are registered trademarks of Digital Theater Systems, Inc. Copyright 1996, 2000 Digital Theater Systems, Inc. All Rights Reserved.*

TABLE OF CONTENTS

Hooking Up the Components 4

Unpacking	4
Antenna Hookups	5
Audio Component Hookups	6
Video Component Hookups	7
Digital Component Hookups	8
MULTI CH IN Hookups	10
Other Hookups	11

Hooking Up and Setting Up the Speaker System 13

Speaker System Hookup	14
Performing Initial Setup Operations	16
Multi Channel Surround Setup	17
Before You Use Your Receiver	21

Location of Parts and Basic Operations 23

Front Panel Parts Descriptions	23
--------------------------------	----

Enjoying Surround Sound 27

Selecting a Sound Field	28
Understanding the Multi-Channel Surround Displays	32
Customizing Sound Fields	34

Receiving Broadcasts 38

Direct Tuning	40
Automatic Tuning	40
Preset Tuning	41

Other Operations 42

Naming Preset Stations and Program Sources	43
Recording	43
Using the Sleep Timer	44
Adjustment Using the SET UP Button	45
CONTROL A1II Control System	45

Additional Information 47

Troubleshooting	47
Specifications	49
Glossary	51
Settings Using SURR, LEVEL, EQ, and SET UP buttons	52
Remote Button Description	53
Index	Back cover

Hooking Up the Components

This chapter describes how to connect various audio and video components to the receiver. Be sure to read the sections for the components you have before you actually connect them to the receiver.

Unpacking

Check that you received the following items with the receiver:

- FM wire antenna (1)
- AM loop antenna (1)
- R6 (size-AA) batteries (2)
- Remote Commander (remote) (1)

Inserting batteries into the remote

Insert R6 (size-AA) batteries with the + and – properly oriented in the battery compartment. When using the remote, point it at the remote sensor  on the receiver.

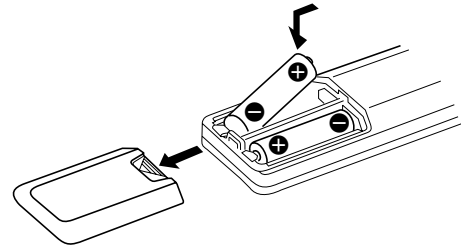

When to replace batteries

Under normal conditions, the batteries should last for about 6 months. When the remote no longer operates the receiver, replace all batteries with new ones.

Notes

- Do not leave the remote in an extremely hot or humid place.
- Do not use a new battery with an old one.
- Do not expose the remote sensor to direct sunlight or lighting apparatuses. Doing so may cause a malfunction.
- If you don't use the remote for an extended period of time, remove the batteries to avoid possible damage from battery leakage and corrosion.

Before you get started

- Turn off the power to all components before making any connections.
- Do not connect the AC power cords until all of the connections are completed.
- Be sure to make connections firmly to avoid hum and noise.
- When connecting an audio/video cord, be sure to match the color-coded pins to the appropriate jacks on the components: yellow (video) to yellow; white (left, audio) to white; and red (right, audio) to red.

Antenna Hookups

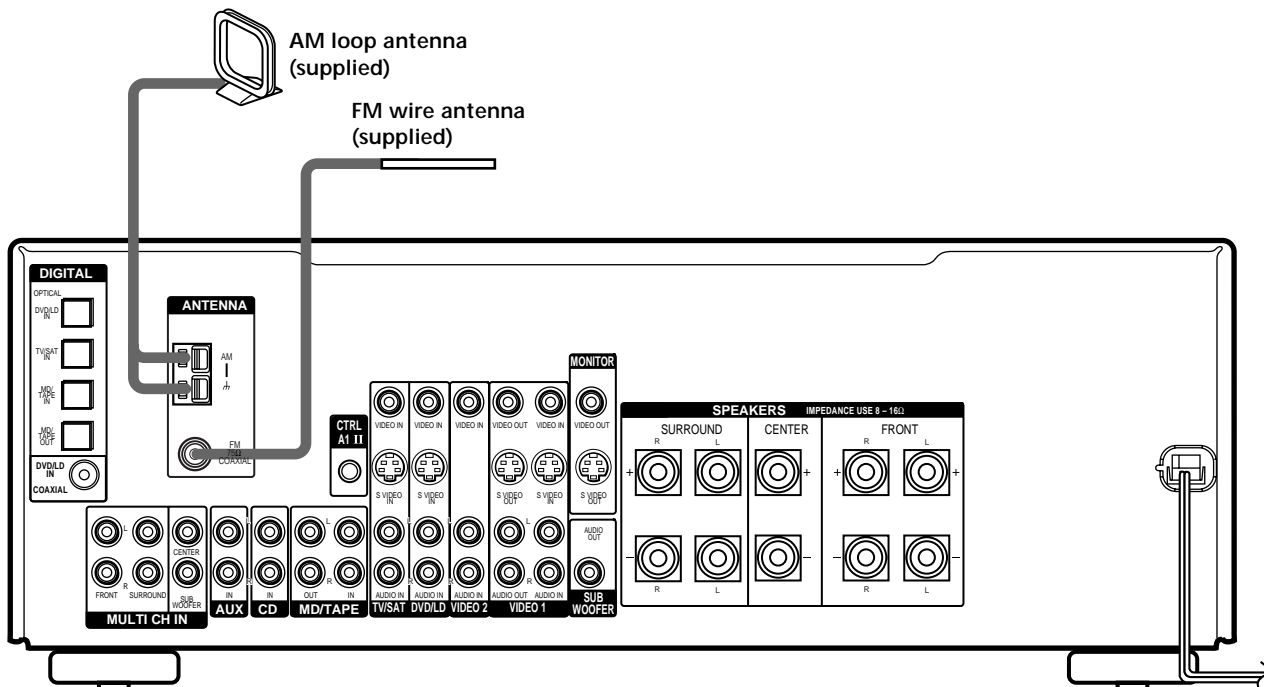

Terminals for connecting the antennas

Connect the	To the
AM loop antenna	AM terminals
FM wire antenna	FM 75Ω COAXIAL terminal

Notes on antenna hookups

- To prevent noise pickup, keep the AM loop antenna away from the receiver and other components.
- Be sure to fully extend the FM wire antenna.
- After connecting the FM wire antenna, keep it as horizontal as possible.

💡 If you have poor FM reception
Use a 75-ohm coaxial cable (not supplied) to connect the receiver to an outdoor FM antenna as shown below.

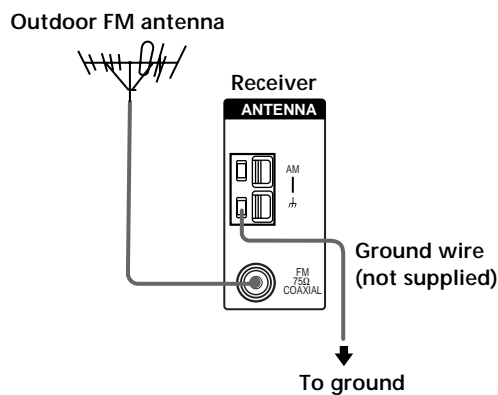

Important

If you connect the receiver to an outdoor antenna, ground it against lightning. To prevent a gas explosion, do not connect the ground wire to a gas pipe.

Audio Component Hookups

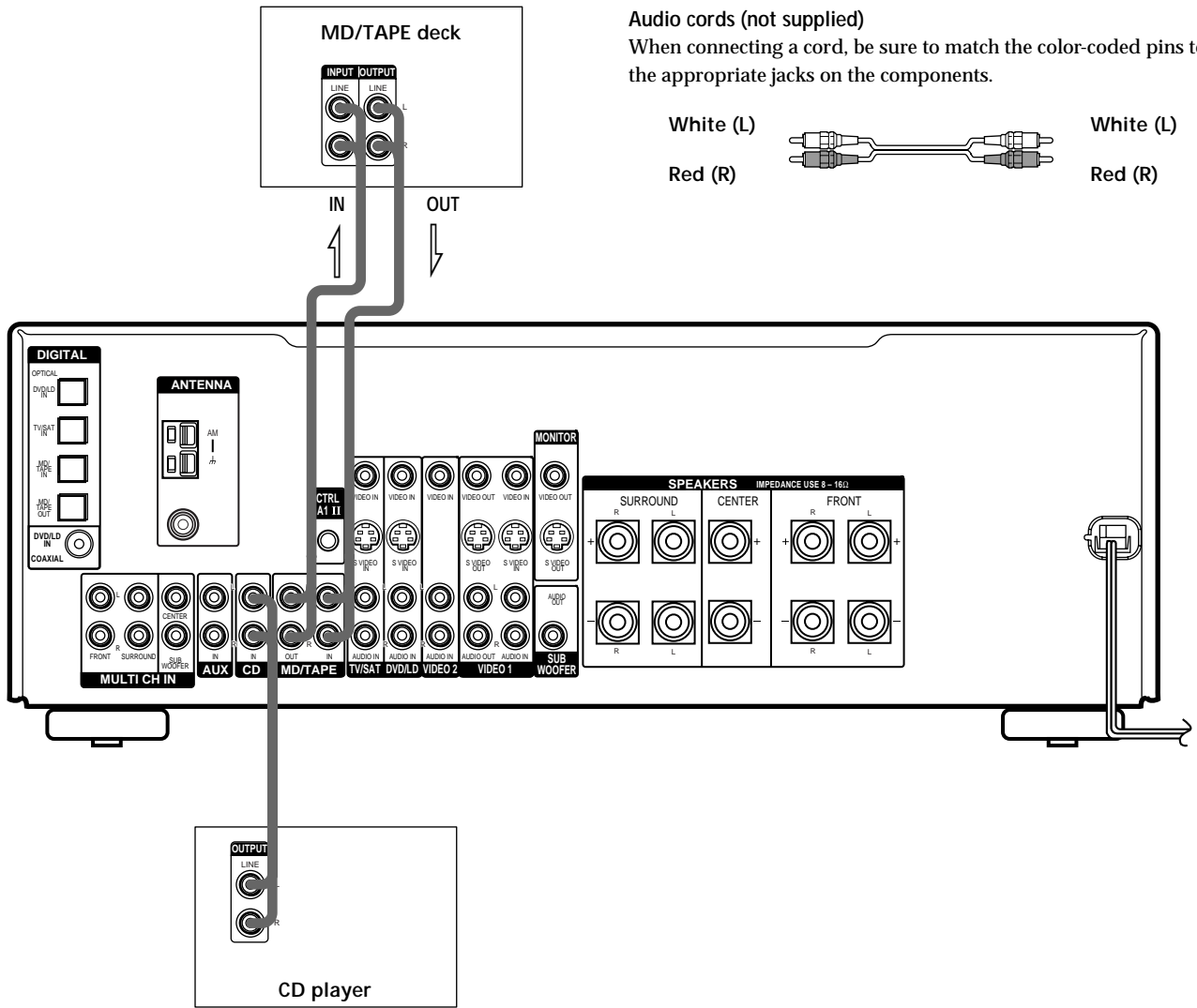

Required cords

Audio cords (not supplied)
When connecting a cord, be sure to match the color-coded pins to the appropriate jacks on the components.

White (L) White (L)
Red (R) Red (R)

Jacks for connecting audio components

Connect a	To the
CD player	CD jacks
MD deck or Tape deck	MD/TAPE jacks

Video Component Hookups

Required cords

Audio/video cords (not supplied)

When connecting a cord, be sure to match the color-coded pins to the appropriate jacks on the components.

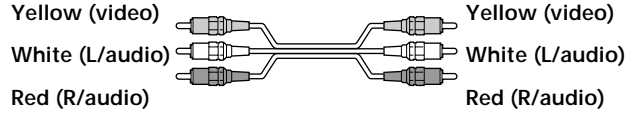

Video cord for connecting a TV monitor (not supplied)

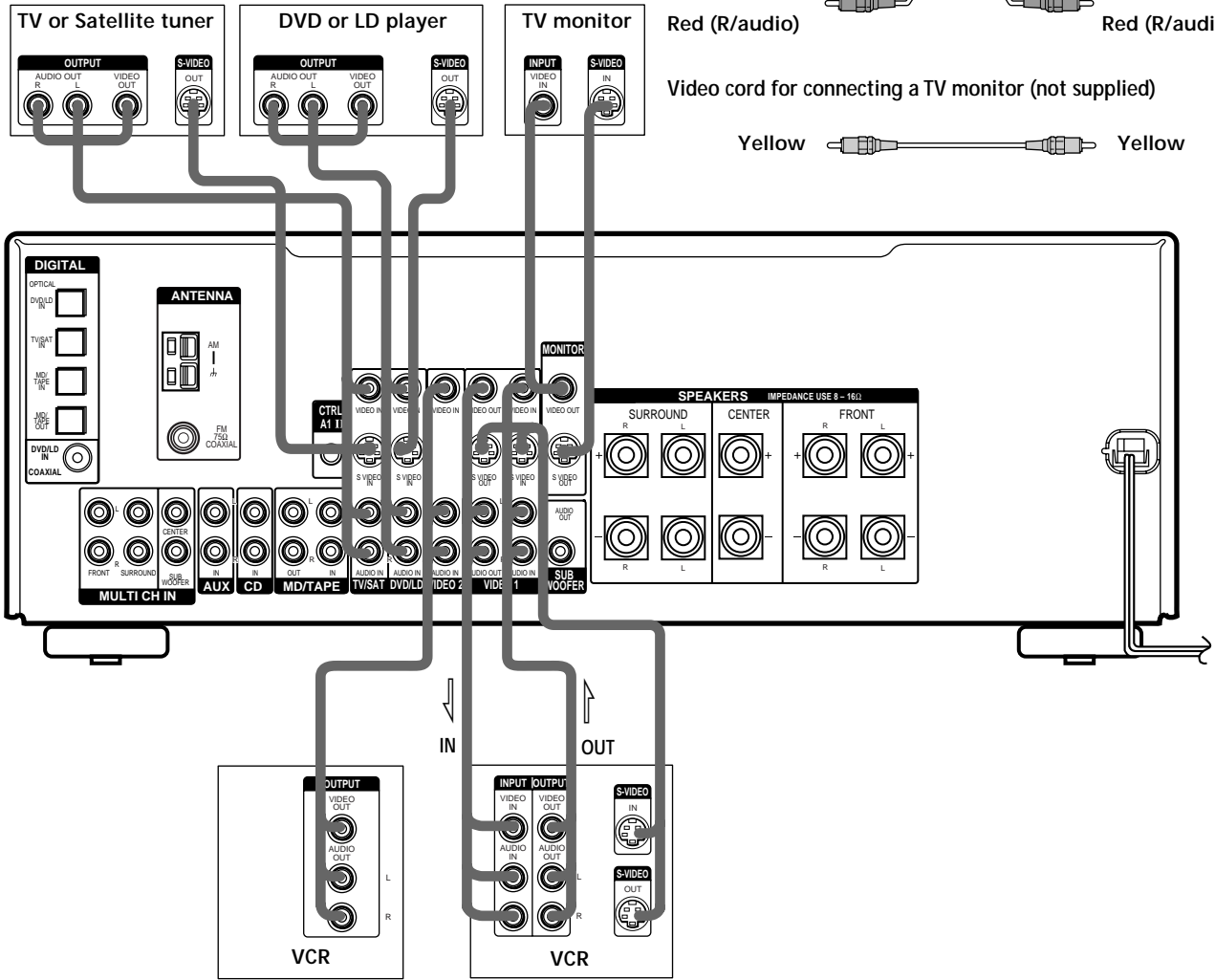
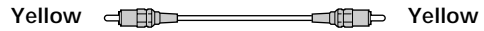

Jacks for connecting video components

Connect a	To the
TV or Satellite tuner	TV/SAT jacks
VCR	VIDEO 1 jacks
Additional VCR	VIDEO 2 jacks
DVD or LD player	DVD/LD jacks
TV monitor	MONITOR VIDEO OUT jack

Note on video component hookups

You can connect your TV's audio output jacks to the TV/SAT AUDIO IN jacks on the receiver and apply sound effects to the audio from the TV. In this case, do not connect the TV's video output jack to the TV/SAT VIDEO IN jack on the receiver. If you are connecting a separate TV tuner (or satellite tuner), connect both the audio and video output jacks to the receiver as shown above.

When using the S-video jacks instead of the video jacks Your monitor must also be connected via an S-video jack. S-video signals are on a separate bus from the video signals and will not be output through the video jacks.

Digital Component Hookups

Connect the digital output jacks of your DVD player and satellite tuner (etc.) to the receiver's digital input jacks to bring the multi channel surround sound of a movie theater into your home. To enjoy full effect of multi channel surround sound, five speakers (two front speakers, two surround speakers, and a center speaker) and a sub woofer are required. You can also connect an LD player with an RF OUT jack via an RF demodulator, such as the Sony MOD-RF1 (not supplied).

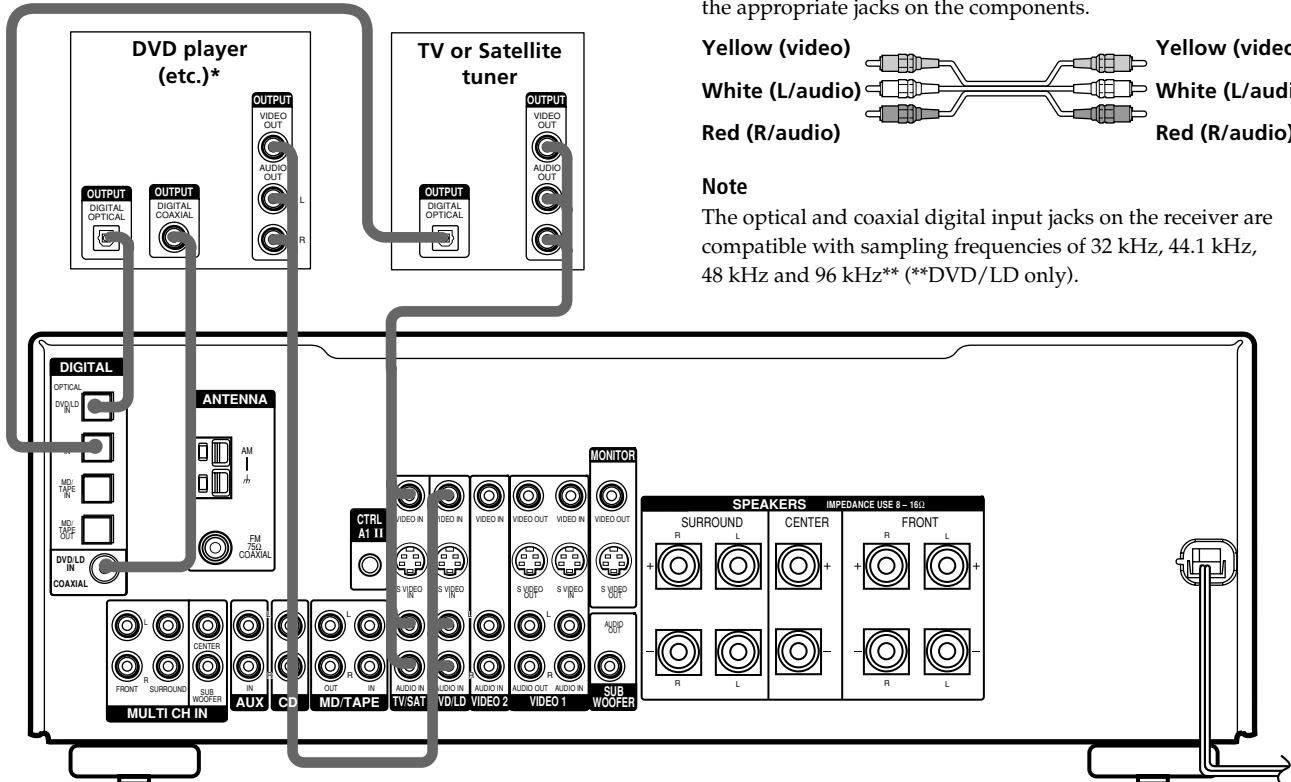

Required cords

Optical digital cords (not supplied)

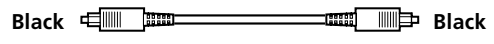

Coaxial digital cord (not supplied)

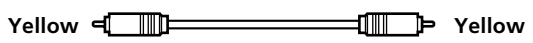

Audio/video cords (not supplied)

When connecting a cord, be sure to match the color-coded pins to the appropriate jacks on the components.

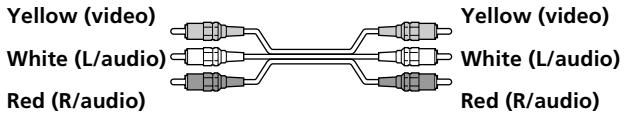

Note

The optical and coaxial digital input jacks on the receiver are compatible with sampling frequencies of 32 kHz, 44.1 kHz, 48 kHz and 96 kHz** (**DVD/LD only).

* When making digital audio connections to a DVD player, connect to either the coaxial OR optical digital jacks, and not both. It is recommended to make digital audio connections to the coaxial jack.

Example of LD player connected via an RF demodulator

Please note that you cannot connect an LD player's AC-3 RF OUT jack directly to the receiver's digital input jacks. You must first convert the RF signal to either an optical or coaxial digital signal. Connect the LD player to the RF demodulator, then connect the RF demodulator's optical or coaxial digital output to the receiver's OPTICAL or COAXIAL DVD/LD IN jack. Refer to the instruction manual supplied with your RF Demodulator for details on AC-3 RF hookups.

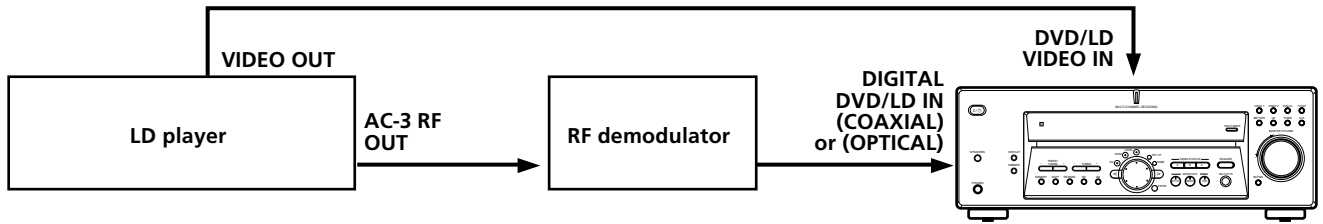

Note

When making connections as shown above, be sure to set INPUT MODE (8) on page 25) manually. The receiver may not operate correctly if INPUT MODE is set to "AUTO."

Connect the digital output jacks of your MD or tape deck to the receiver's digital input jack and connect the digital input jacks of your MD or tape deck to the receiver's digital output jack. These connections allow you to make digital recordings of a CDs played back through your DVD (or LD player) and satellite broadcasts.

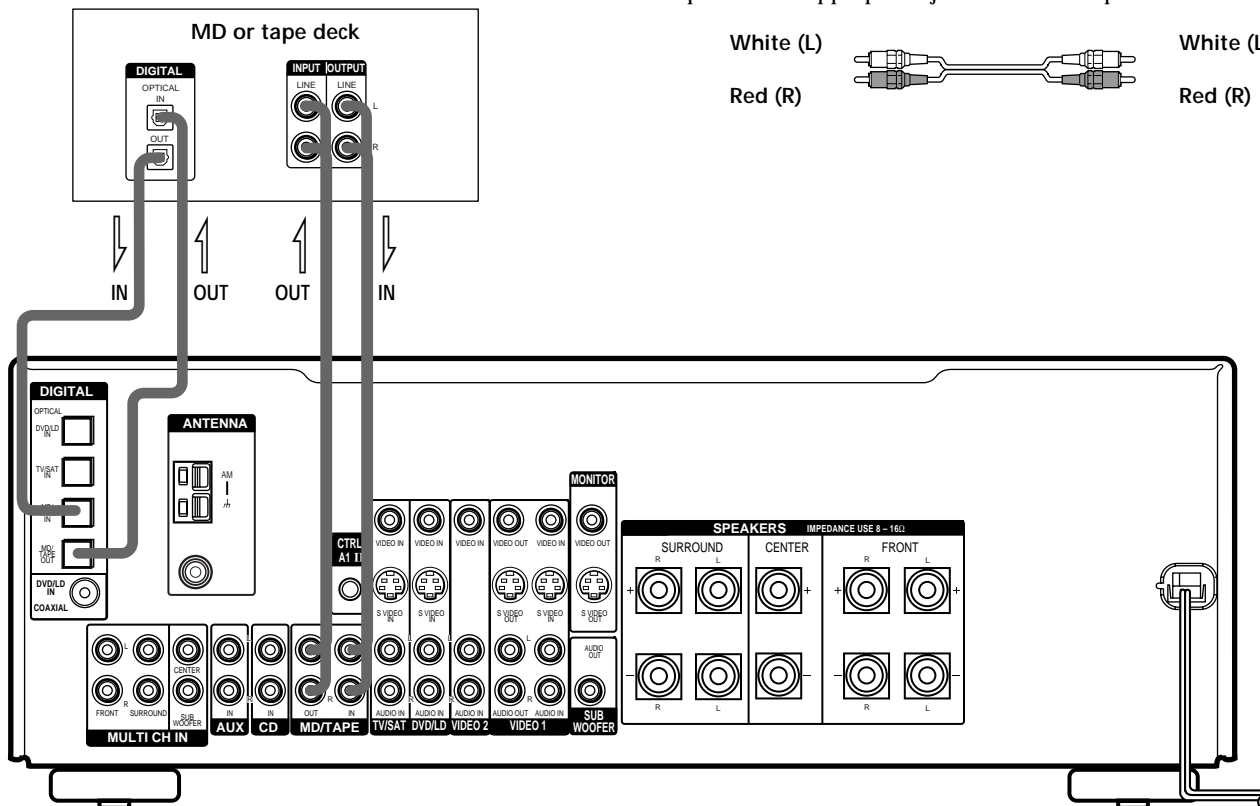

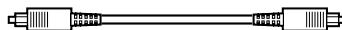

Required cords

Optical digital cords (not supplied)

Black  Black

Audio cords (not supplied)

When connecting a cord, be sure to match the color-coded pins to the appropriate jacks on the components.

White (L)  White (L)
 Red (R)  Red (R)

Notes

- Please note that you cannot make a digital recording of a digital multi channel surround signal.
- To make a digital recording from your CD player, connect the CD player's digital output directly to the digital input on your MD or tape deck. Refer to the instructions supplied with your CD player and MD or tape deck for details.
- The DVD/LD IN OPTICAL and COAXIAL jacks are compatible with 96 kHz, 48 kHz, 44.1 kHz and 32 kHz sampling frequencies. The other OPTICAL jacks are compatible with 48 kHz, 44.1 kHz and 32 kHz sampling frequencies.
- It is not possible to record analog signals to TAPE and VIDEO with only digital connections. To record analog signals, make analog connections. To record digital signals, make digital connections.
- Input signals with 96 kHz sampling frequencies to the DVD/LD IN OPTICAL or COAXIAL jacks. Using other jacks may result in intermittent sound.

MULTI CH IN Hookups

Although this receiver incorporates a multi channel decoder, it is also equipped with MULTI CH IN jacks. These connections allow you to enjoy multichannel software encoded in formats other than Dolby Digital and DTS. If your DVD player is equipped with MULTI CH OUTPUT jacks, you can connect them directly to the receiver to enjoy the sound of the DVD player's multi channel decoder. Alternatively, the MULTI CH IN jacks can be used to connect an external multi channel decoder. To fully enjoy multi channel surround sound, you will need five speakers (two front speakers, two surround speakers, and a center speaker) and a subwoofer. Refer to the instruction manual supplied with your DVD player, multi channel decoder, etc., for details on the multi channel input hookups.

Required cords

Audio cords (not supplied)

Two for the MULTI CH IN FRONT and SURROUND jacks



Monaural audio cords (not supplied)

Two for the MULTI CH IN CENTER and SUB WOOFER jacks



Video cord (not supplied)

One for the DVD/LD VIDEO IN jacks (etc.)

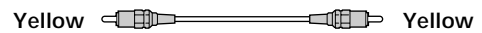

Note

When using the connections described below, adjust the level of your surround speakers and subwoofer from the DVD player or multichannel decoder.

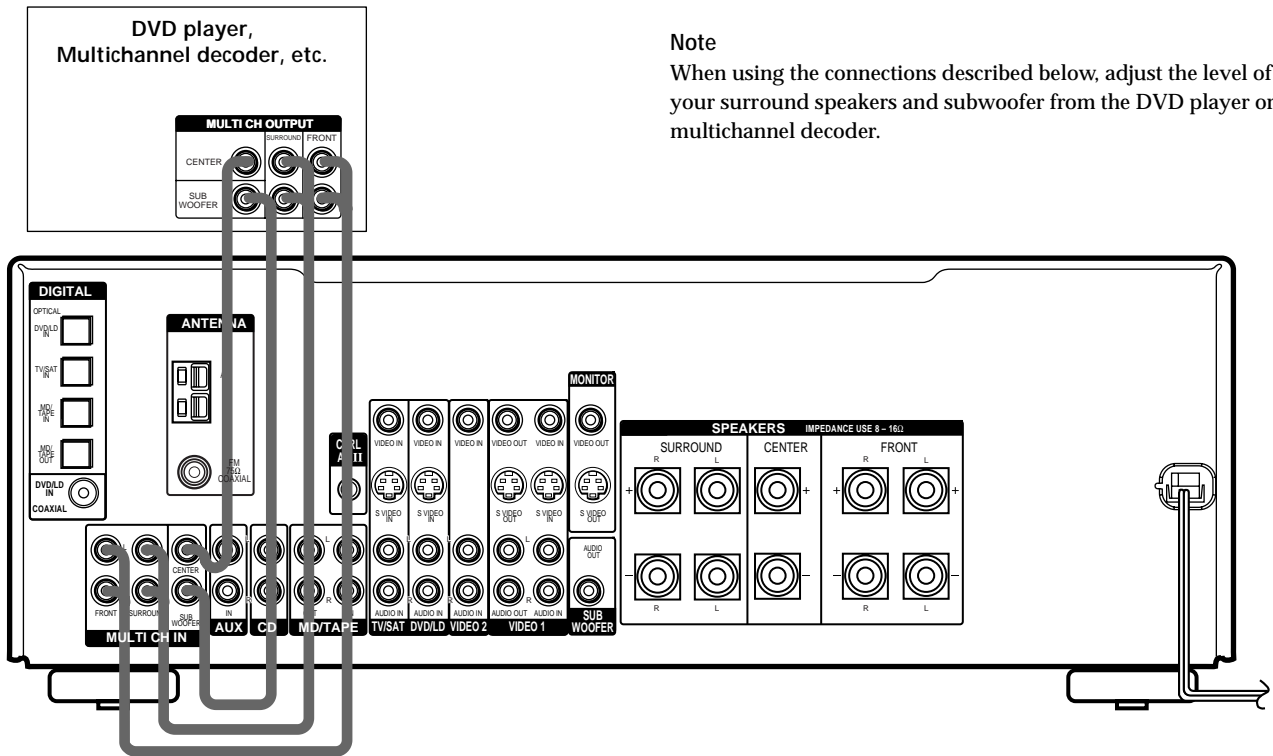

Example of a DVD player hookup using the MULTI CH IN jacks

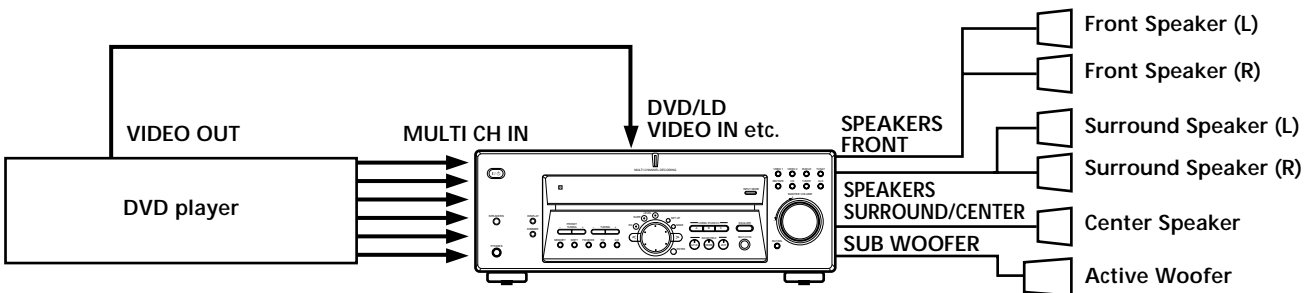

Note

See page 14 for details on speaker system hookup.

Other Hookups

Required cords

Audio cords (not supplied)

When connecting a cord, be sure to match the color-coded pins to the appropriate jacks on the components.

White (L)		White (L)
Red (R)		Red (R)

CONTROL A1 connecting cord (not supplied)

Black		Black
-------	--	-------

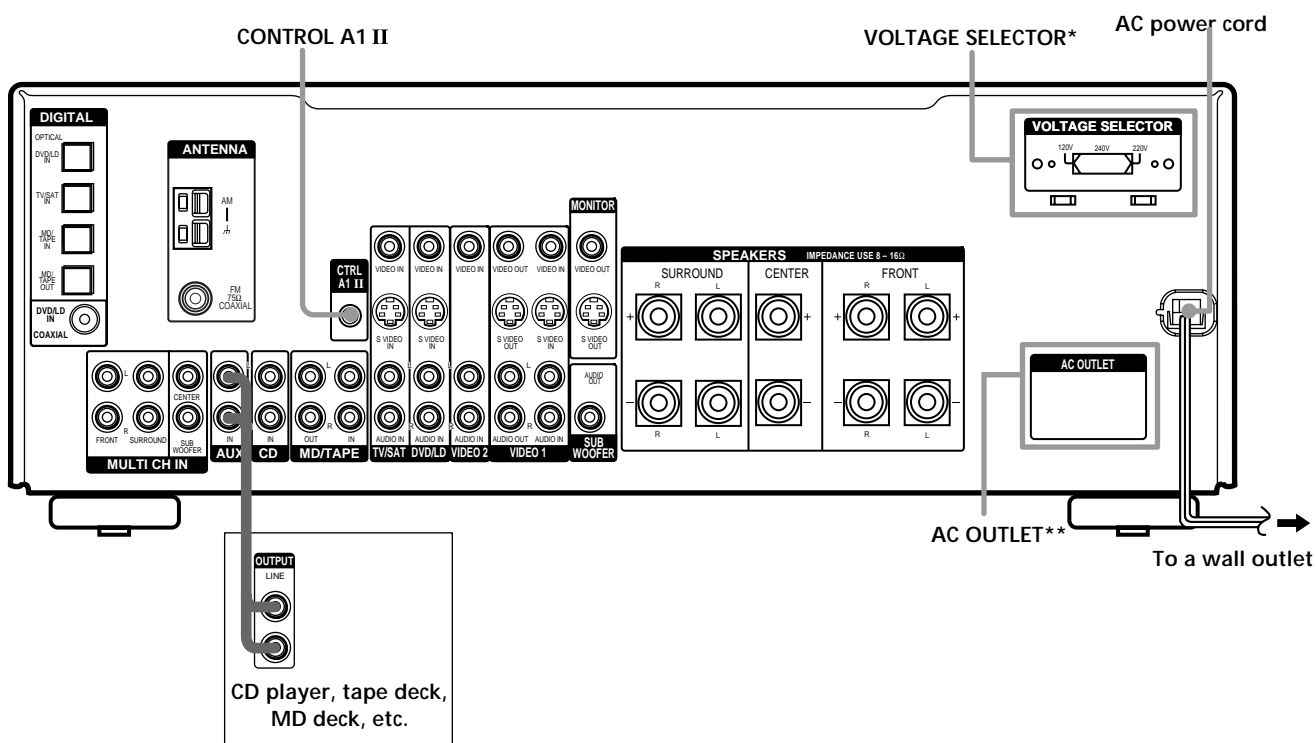

* Models of area code E2, E3 only.

** The configuration, shape and number of AC outlets on the rear panel varies according to the model and country to which the receiver is shipped. (except models of area code CN).

Other Hookups

CONTROL A1 II hookup

- **If you have a CONTROL A1 II compatible Sony CD player, tape deck, or MD deck**
Use a CONTROL A1 cord (not supplied) to connect the CONTROL A1 II jack on the CD player, tape deck, or MD deck to the CONTROL A1 II jack on the receiver. Refer “CONTROL-A1 II Control System” on page 45 and the operating instructions supplied with your CD player, tape deck, or MD deck for details.

Note

If you make CONTROL A1 II connections from the receiver to an MD deck that is also connected to a computer, do not operate the receiver while using the “Sony MD Editor” software. This may cause a malfunction.

- **If you have a Sony CD changer with a COMMAND MODE selector**
If your CD changer’s COMMAND MODE selector can be set to CD 1, CD 2, or CD 3, be sure to set the command mode to “CD 1” and connect the changer to the CD jacks on the receiver.
If, however, you have a Sony CD changer with VIDEO OUT jacks, set the command mode to “CD 2” and connect the changer to the VIDEO IN jacks on the receiver.

AUX AUDIO IN hookup

- **If you have an individual audio component (except PHONO)**
Use the audio cords to connect the LINE OUT jacks on the CD player, tape deck, or MD deck to the AUX AUDIO IN jack on the receiver so that you can listen to stereo sources in surround sound.

Setting the VOLTAGE SELECTOR (Models of area code E2, E3 only)

Check that the voltage selector on the rear panel of the player is set to the local power line voltage. If not, set the selector to the correct position using a screwdriver before connecting the AC power cord to a wall outlet.

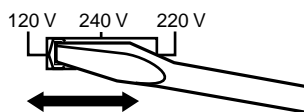

Connecting the AC power cord

Before connecting the AC power cord of this receiver to a wall outlet:

- Connect the speaker system to the receiver (see page 14).

Connect the AC power cord(s) of your audio/video components to a wall outlet.

If you connect other audio/video components to the AC OUTLET(s) on the receiver, the receiver will supply power to the connected component(s), allowing you to turn the whole system on or off when you turn the receiver on or off. (except models of area code CN)

Caution

Make sure that the total power consumption of the component(s) connected to the receiver’s AC OUTLET(s) does not exceed the wattage stated on the rear panel. Do not connect high-wattage electrical home appliances such as electric irons, fans, or TVs to this outlet. (except models of area code CN)

Note

If the AC power cord is disconnected for about one week, the receiver’s entire memory will be cleared and the demonstration will start.

Hooking Up and Setting Up the Speaker System

This chapter describes how to hook up your speaker system to the receiver, how to position each speaker, and how to set up your speakers to enjoy multi channel surround sound.

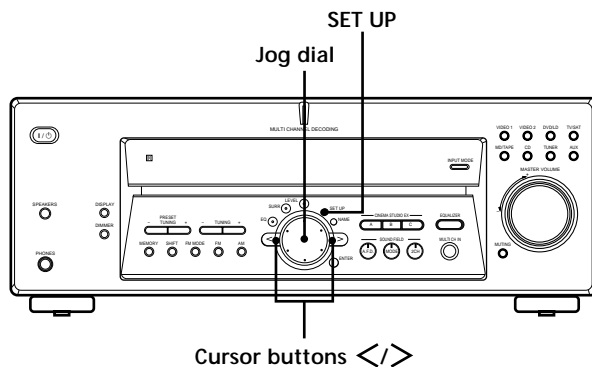

Brief descriptions of buttons and control used to set up the speaker system

SET UP button: Press to enter the setup mode when specifying speaker types and distances.

Cursor buttons (</>): Use to select parameters after pressing the SET UP button.

Jog dial: Use to adjust the setting of each parameter.

Speaker System Hookup

Required cords

Speaker cords (not supplied)

One for each front, surround, and center speaker



Monaural audio cord (not supplied)

One for an active sub woofer

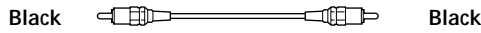

Black

Black

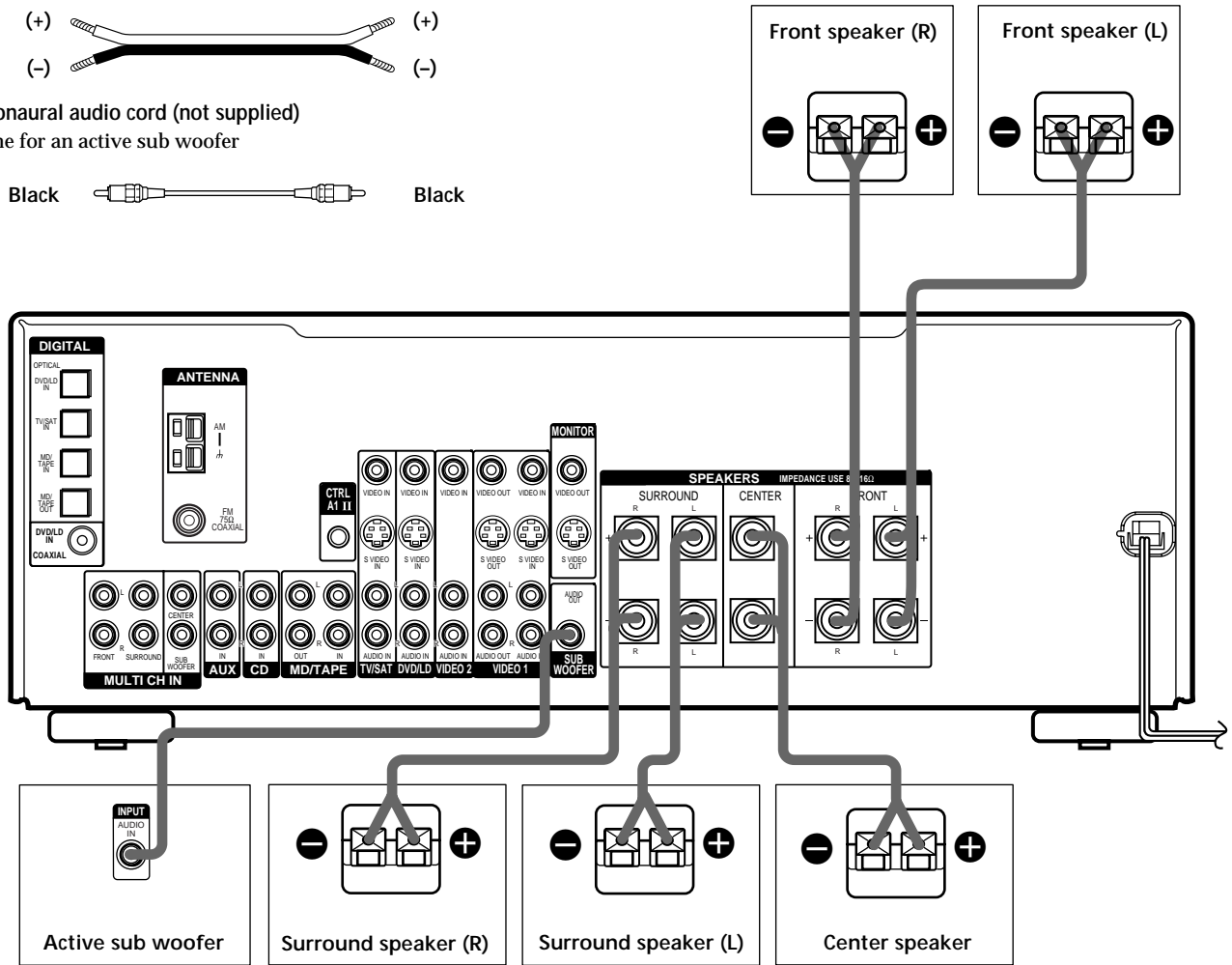

Terminals for connecting the speakers

Connect the	To the
Front speakers (8 ohm)	SPEAKERS FRONT terminals
Surround speakers (8 ohm)	SPEAKERS SURROUND terminals
Center speaker (8 ohm)	SPEAKERS CENTER terminals
Active sub woofer	SUB WOOFER AUDIO OUT jack

Notes on speaker system hookup

- Twist the stripped ends of the speaker cords about 10 mm (2/3 inch). Be sure to match the speaker cord to the appropriate terminal on the components: + to + and - to -. If the cords are reversed, the sound will be distorted and will lack bass.
- If you use speakers with low maximum input rating, adjust the volume carefully to avoid excessive output on the speakers.

To avoid short-circuiting the speakers

Short-circuiting of the speakers may damage the receiver. To prevent this, make sure to take the following precautions when connecting the speakers.

Make sure the stripped ends of each speaker cord does not touch another speaker terminal or the stripped end of another speaker cord.

Examples of poor conditions of the speaker cord

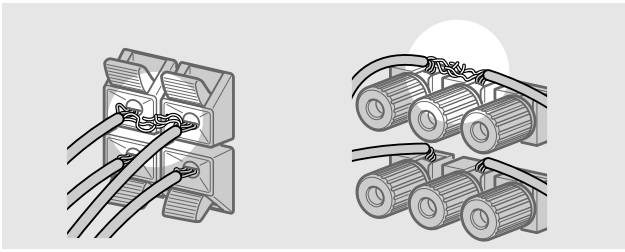

Stripped speaker cord is touching another speaker terminal.

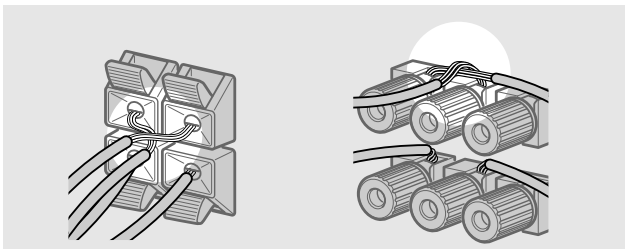

Stripped cords are touching each other due to excessive removal of insulation.

After connecting all the components, speakers, and AC power cord, output a test tone to check that all the speakers are connected correctly. For details on outputting a test tone, see page 20.

If no sound is heard from a speaker while outputting a test tone or a test tone is output from a speaker other than the one whose name is currently displayed on the receiver, the speaker may be short-circuited. If this happens, check the speaker connection again.

To avoid damaging your speakers

Make sure that you turn down the volume before you turn off the receiver. When you turn on the receiver, the volume remains at the level you turn off the receiver.

Performing Initial Setup Operations

Once you have made speaker connections and have turned on the power for the first time, clear the receiver's memory. After you have done this, set the speaker sizes, speaker locations and other initial system settings that are necessary.

Clearing the receiver's memory

Before you use your receiver for the first time or when you want to clear the receiver's memory, do the following. If the Demonstration appears when the power is turned on, this procedure is not necessary.

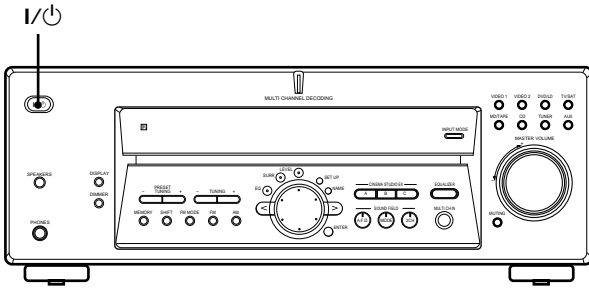

1 Turn off the receiver.

2 Hold down I/O for four seconds.

The currently selected function, then the demonstration message appears in the display and the items including the following are reset or cleared:

- All preset stations are reset or cleared.
- All sound field parameters are reset to their factory settings.
- All index names (of preset stations and program sources) are cleared.
- All adjustments made with the SET UP button are reset to their factory settings.
- The sound field memorized for each program source and preset stations are cleared.

Setting up the receiver

Before you use your receiver for the first time, use the SET UP button to adjust settings to correspond to your system. You can set the following items. For details on how to adjust each setting, see the page in parentheses.

- Set the speaker size (page 17).
- Set the speaker distance (page 19).
- Select the MULTI CH IN video signal (page 45).
- Whether the display turns off or not when you press DIMMER (page 45).

Demonstration Mode

The demonstration will activate the first time you turn on the power. When the demonstration starts, the following message appears in the display :

"NOW DEMONSTRATION MODE IF YOU FINISH
DEMONSTRATION PLEASE PRESS POWER KEY
WHILE THIS MESSAGE APPEARS IN THE DISPLAY
THANK YOU"

To cancel the demonstration

Press I/O to turn the receiver off while the above message is being displayed. The next time you turn the receiver on, the demonstration will not appear.

To view the demonstration

Hold down SET UP and press I/O to turn on the power.

Notes

- Running the demonstration will clear the receiver's memory. For details on what will be cleared, see "Clearing the receiver's memory" on this page.
- There will be no sound when the demonstration mode is activated.
- You cannot cancel demonstration if you did not press I/O while the above message is being displayed. To cancel demonstration after the above message appears, press I/O twice to activate the demonstration again. Then, press I/O while the above message is being displayed.

Multi Channel Surround Setup

For the best possible surround sound all speakers should be the same distance from the listening position (A). (However, this unit lets you to place the center speaker up to 1.5 meters (5 feet) closer (B) and the surround speakers up to 4.5 meters (15 feet) closer (C) to the listening position.

The front speakers can be placed from 1.0 to 12.0 meters (3 to 40 feet) from the listening position (A).)

You can place the surround speakers either behind you or to the side, depending on the shape of your room (etc.).

When the surround speakers are placed to the side

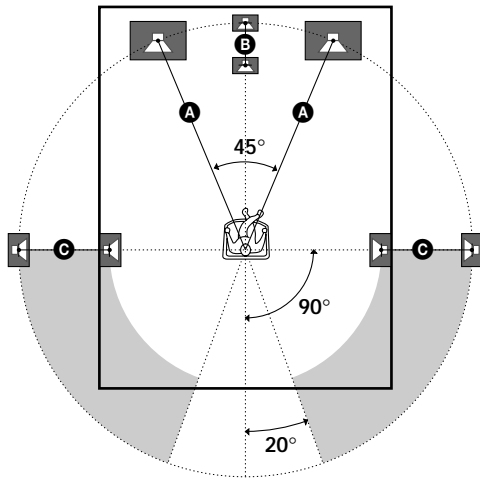

When the surround speakers are placed behind you

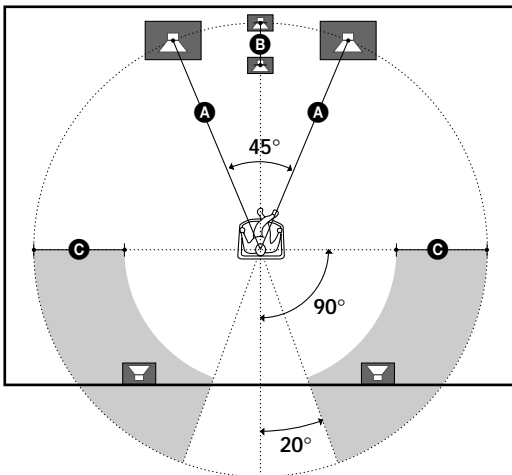

Note

Do not place the center speaker farther away from the listening position than the front speakers.

Specifying the speaker parameters

- 1 Press I/⏻ to turn on the receiver.
- 2 Press SET UP.
- 3 Press the cursor buttons (< or >) to select the parameter you want to adjust.
- 4 Turn the jog dial to select the setting you want. The setting is stored automatically.
- 5 Repeat steps 3 and 4 until you have set all of the parameters that follow.



Normal speaker and Micro Satellite speaker

Choose NORM. SP. if you're using normal speakers and MICRO SP. if you're using Micro Satellite speakers. If you choose NORM. SP., you can adjust the speaker size and the sub woofer selection as mentioned below. However, if you choose MICRO SP., the speaker size and the sub woofer selection has been configured as follows:

Speakers	Settings
Front	SMALL
Center	SMALL
Surround	SMALL
Woofer	YES

You cannot change the configuration if you choose MICRO SP.

The setting for Micro Satellite speaker (MICRO SP.) has been programmed to optimize the sound balance. If you use Sony's Micro Satellite speakers, select MICRO SP. When you use Micro Satellite speaker and the speaker size is set to LARGE, you may not obtain the correct soundstage. The speaker may also be damaged at high volume position.

Multi Channel Surround Setup

■ Front speaker size (L R)

Initial setting : LARGE

- If you connect large speakers that will effectively reproduce bass frequencies, select "LARGE". Normally, select "LARGE".
- If the sound is distorted, or you feel a lack of surround effects when using multi channel surround sound, select "SMALL" to activate the bass redirection circuitry and output the front channel bass frequencies from the sub woofer.
- When the front speaker is set to "SMALL", the center and surround speakers are also automatically set to "SMALL" (unless previously set to "NO").

■ Center speaker size (C)

Initial setting : LARGE

- If you connect a large speaker that will effectively reproduce bass frequencies, select "LARGE". Normally, select "LARGE". However, if the front speakers are set to "SMALL", you cannot set the center speaker to "LARGE".
- If the sound is distorted, or you feel a lack of surround effects when using multi channel surround sound, select "SMALL" to activate the bass redirection circuitry and output the center channel bass frequencies from the front speakers (if set to "LARGE") or sub woofer.*¹
- If you do not connect the center speaker, select "NO". The sound of the center channel will be output from the front speakers.*²

■ Surround speaker size (SL SR)

Initial setting : LARGE

- If you connect large speakers that will effectively reproduce bass frequencies, select "LARGE". Normally, select "LARGE". However, if the front speakers are set to "SMALL", you cannot set the surround speakers to "LARGE".
- If the sound is distorted, or you feel a lack of surround effects when using multi channel surround sound, select "SMALL" to activate the bass redirection circuitry and output the surround channel bass frequencies from the sub woofer or other "LARGE" speakers.
- If you do not connect surround speakers, select "NO".*³

*1~*3 correspond to the following Dolby Pro Logic modes

*¹ NORMAL

*² PHANTOM

*³ 3 STEREO

💡 About speaker sizes (LARGE and SMALL)

Internally, the LARGE and SMALL settings for each speaker determine whether or not the internal sound processor will cut the bass signal from that channel. When the bass is cut from a channel the bass redirection circuitry sends the corresponding bass frequencies to the sub woofer or other "LARGE" speaker. However, since bass sounds have a certain amount of directionality it best not to cut them, if possible. Therefore, even when using small speakers, you can set them to "LARGE" if you want to output the bass frequencies from that speaker. On the other hand, if you are using a large speaker, but prefer not to have bass frequencies output from that speaker, set it to "SMALL".

If the overall sound level is lower than you prefer, set all speakers to "LARGE". If there is not enough bass, you can use the equalizer to boost the bass levels. To adjust the equalizer, see page 36.

■ Surround speaker position (SL SR)*

Initial setting : PL. BEHD.

This parameter lets you specify the location of your surround speakers for proper implementation of the Digital Cinema Sound surround modes in the "VIRTUAL" sound fields. Refer to the illustration below.

- Select "PL. SIDE" if the location of your surround speakers corresponds to section A.
- Select "PL. MID" if the location of your surround speakers corresponds to section B.
- Select "PL. BEHD." if the location of your surround speakers corresponds to section C.

This setting only effects the surround modes in the "VIRTUAL" sound fields.

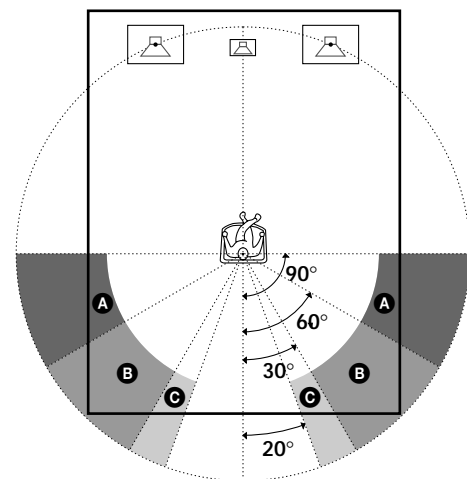

* These parameters are not available when "Surround speaker size" is set to "NO".

■ Surround speaker height (SL SR)*

Initial setting : HGT. LOW

This parameter lets you specify the height of your surround speakers for proper implementation of the Digital Cinema Sound surround modes in the "VIRTUAL" sound fields. Refer to the illustration below.

- Select "HGT. LOW" if the location of your surround speakers corresponds to section **A**.
- Select "HGT. HIGH" if the location of your surround speakers corresponds to section **B**.

This setting only affects the surround modes in the "VIRTUAL" sound fields.

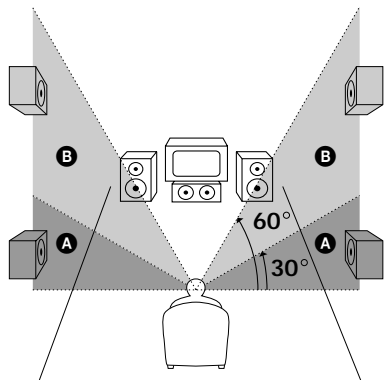

* These parameters are not available when "Surround speaker size" is set to "NO".

💡 About the surround speaker position (PL. SIDE, PL. MID and PL. BEHD.)

This setting is designed specifically for implementation of the Digital Cinema Sound modes in the "VIRTUAL" sound fields. With the Digital Cinema Sound modes, speaker position is not as critical as other modes. All of the modes in the "VIRTUAL" sound fields were designed under the premise that the surround speaker would be located behind the listening position, but presentation remains fairly consistent even with the surround speakers positioned at a rather wide angle. However, if the speakers are pointing toward the listener from the immediate left and right of the listening position, the "VIRTUAL" sound fields will not be effective unless the surround speaker position parameter is set to "PL. SIDE".

Nevertheless, each listening environment has many variables, such as wall reflections, and you may obtain better results using "PL. BEHD." or "PL. MID" if your speakers are located high above the listening position, even if they are to the immediate left and right. Therefore, although it may result in a setting contrary to the "Surround speaker position" explanation, we recommend that you play back multi channel surround encoded software and listen to the effect each setting has on your listening environment. Choose the setting that provides a good sense of spaciousness and that best succeeds in forming a cohesive space between the surround sound from the surround speakers and the sound from the front speakers. If you are not sure which sounds best, select "PL. BEHD." and then use the speaker distance parameter and speaker level adjustments to obtain proper balance.

■ Sub woofer selection

Initial setting : S. W. YES

- If you connect a sub woofer, select "S. W. YES".
- If you do not connect a sub woofer, select "S. W. NO". This activates the bass redirection circuitry and outputs the LFE signals from other speakers.
- In order to take full advantage of the Dolby Digital (AC-3) bass redirection circuitry, we recommend that you set your sub woofer's cut off frequency as high as possible.

■ Front speaker distance (L R)

Initial setting : DIST. 5.0 m (5.0 meter)

Set the distance from your listening position to the front (left or right) speaker (**A** on page 17).

- Front speaker distance can be set in 0.1 meter (1 foot) steps from 1.0 to 12.0 meters (3 to 40 feet).
- If both speakers are not placed an equal distance from your listening position, set the distance to the closest speaker.

■ Center speaker distance (C)

Initial setting : DIST. 5.0 m (5.0 meter)

Set the distance from your listening position to the center speaker.

- Center speaker distance can be set in 0.1 meter (1 foot) steps from a distance equal to the front speaker distance (**A** on page 17) to a distance 1.5 meters (5 feet) closer to your listening position (**E** on page 17).
- Do not place the center speaker farther away from your listening position than the front speakers.

■ Surround speaker distance (SL SR)

Initial setting : DIST. 3.5 m (3.5 meter)

Set the distance from your listening position to the surround (left or right) speaker.

- Surround speaker distance can be set in 0.1 meter (1 foot) steps from a distance equal to the front speaker distance (**A** on page 17) to a distance 4.5 meters (15 feet) closer to your listening position (**C** on page 17).
- Do not place the surround speakers farther away from your listening position than the front speakers.
- If both speakers are not placed an equal distance from your listening position, set the distance to the closest speaker.



About speaker distances

This receiver allows you to input the speaker position in terms of distance. However, it is not possible to set the center speaker farther away than the front speakers. Also, the center speaker can not be set more than 1.5 meters (5 feet) closer than the front speakers.

Likewise, the surround speakers cannot be set farther away from the listening position than the front speakers. And they can be no more than 4.5 meters (15 feet) closer.

This is because incorrect speaker placement is not conducive to enjoy the surround sound.

Please note that, setting the speaker distance closer than the actual location of the speakers will cause a delay in the output of the sound from that speaker. In other words, the speaker will sound like it is farther away.

For example, setting the center speaker distance 1~2 m (3~6 feet) closer than the actual speaker position will create a fairly realistic sensation of being "inside" the screen. If you cannot obtain a satisfactory surround effect because the surround speakers are too close, setting the surround speaker distance closer (shorter) than the actual distance will create a larger soundstage. (1 foot corresponds to a 1 ms difference.)

Adjusting these parameters while listening to the sound often results in much better surround sound. Give it a try!

Adjusting the speaker volume

Use the remote while seated in your listening position to adjust the volume of each speaker.

Note

This receiver incorporates a new test tone with a frequency centered at 800 Hz for easier speaker volume adjustment.

- 1 Press I/⏻ to turn on the receiver.
- 2 Press TEST TONE on the supplied remote.
You will hear the test tone from each speaker in sequence.
- 3 Adjust the volume level so that the volume of the test tone from each speaker sounds the same when you are in your main listening position.
 - To adjust the balance of the front right and front left speakers, use the front balance parameter in the LEVEL menu (see page 35).
 - To adjust the balance of the surround right and surround left speakers, use the surround balance parameter in the LEVEL menu (see page 35).
 - To adjust the volume level of the center speaker, press MENU </> to select the center parameter. Use +/- on the remote to adjust the level.
 - To adjust the volume level of the surround speaker, press MENU </> to select the surround parameter. Use +/- on the remote to adjust the level.
- 4 Press TEST TONE on the remote again to turn off the test tone.

Note

The test tone cannot be output when the receiver is set to MULTI CH IN.



You can adjust the volume level of all speakers at the same time

Rotate MASTER VOLUME on the receiver or press MASTER VOL +/- on the remote.

Notes

- The front balance, surround balance, center level, and surround level are shown in the display during adjustment.
- Although these adjustments can also be made via the front panel using the LEVEL menu (when the test tone is output, the receiver switches to the LEVEL menu automatically), we recommend you follow the procedure described above and adjust the speaker levels from your listening position using the remote control.

💡 When setting the volume levels for each speaker

Let's assume that you have matched the sound levels of all the speakers using the test tone. Although this lays the foundation for high quality surround sound, it may be necessary to make further adjustments while listening to playback of actual software. This is because most software contains center and surround channels recorded at slightly lower levels than the two front channels.

When you actually play back software recorded in multi channel surround, you will notice that increasing the center and surround speaker levels produces a better blend between the front and center speakers and greater cohesion between the front and surround speakers. Increasing the level of the center speaker about 1 dB, and the surround speakers about 1~2 dB is likely to produce better results.

In other words, in order to create a more cohesive soundstage with balanced dialog, we recommend that you make some adjustments while playing your software. Changes of only 1 dB can make a huge difference in the character of the soundstage.

Before You Use Your Receiver

Checking the connections

After connecting all of your components to the receiver, do the following to verify that the connections were made correctly.

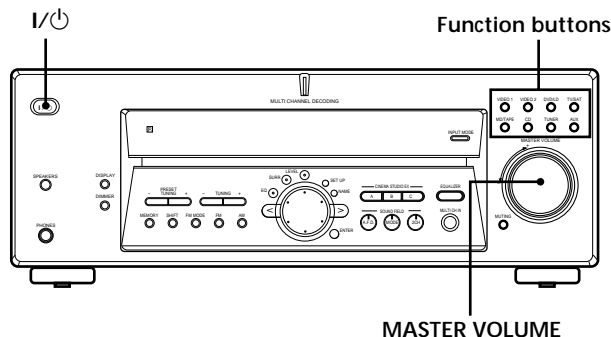

- 1 Press I/Power to turn on the receiver.
- 2 Press a function button to select a component (program source) that you connected (e.g., CD player or tape deck).
- 3 Turn on the component and start playing it.
- 4 Rotate MASTER VOLUME to turn up the volume.

If you do not obtain normal sound output after performing this procedure, look for the reason in the checklist on the following page and take the appropriate measures to correct the problem.

There is no sound no matter which component is selected.

- ➔ Check that both the receiver and all components are turned on.
- ➔ Check that the volume level on the display is not set to VOL MIN by turning the MASTER VOLUME.
- ➔ Check that the SPEAKERS button is not set to OFF.
- ➔ Check that all speaker cords are connected correctly.
- ➔ Press the MUTING if MUTING appears on the display.
- ➔ Check that the headphones are not connected to the PHONES jack. No sound will come from the speakers if the headphones are connected.
- ➔ Check that the receiver is not in "Demonstration Mode" (see page 16).

Before You Use Your Receiver

There's no sound from a specific component.

- ➔ Check that the component is connected correctly to audio input jacks for that component.
- ➔ Check that the cord(s) used for the connection is (are) fully inserted into the jacks on both the receiver and the component.

No sound is heard from one of the front speakers.

- ➔ Connect a pair of headphones to the PHONES jack to verify that sound is output from the headphones (see "14 SPEAKERS button" and "PHONES jack" on page 25).
If only one channel is output from the headphones, the component may not be connected to the receiver correctly. Check that all the cords are fully inserted into the jacks on both the receiver and the component.
If both channels are output from the headphones, the front speaker may not be connected to the receiver correctly. Check the connection of the front speaker which is not outputting any sound.

If you encounter a problem that is not included above, see "Troubleshooting" on page 47.

Location of Parts and Basic Operations

This chapter provides information about the locations and functions of the buttons and controls on the front panel. It also explains basic operations.

Front Panel Parts Descriptions

1 I/⏻ switch

Press to turn the receiver on and off.

2 DISPLAY button

Press repeatedly to change the information on the display window as follows:

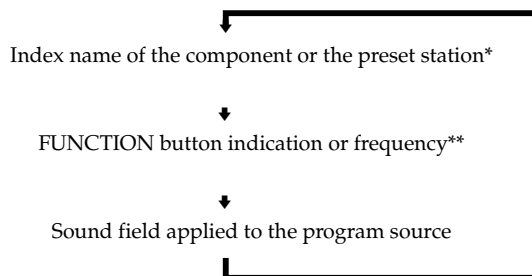

* Index name appears only when you have assigned one to the component or preset station (see page 41). Index name does not appear when only blank spaces have been entered, or it is the same as the function button.

** Frequency appears only when the tuner is selected.

3 DIMMER button

Press repeatedly to adjust the brightness of the display. When you want to turn off the display, set in the "DIM.RANGE" parameter in the SET UP menu (page 45).

Front Panel Parts Description

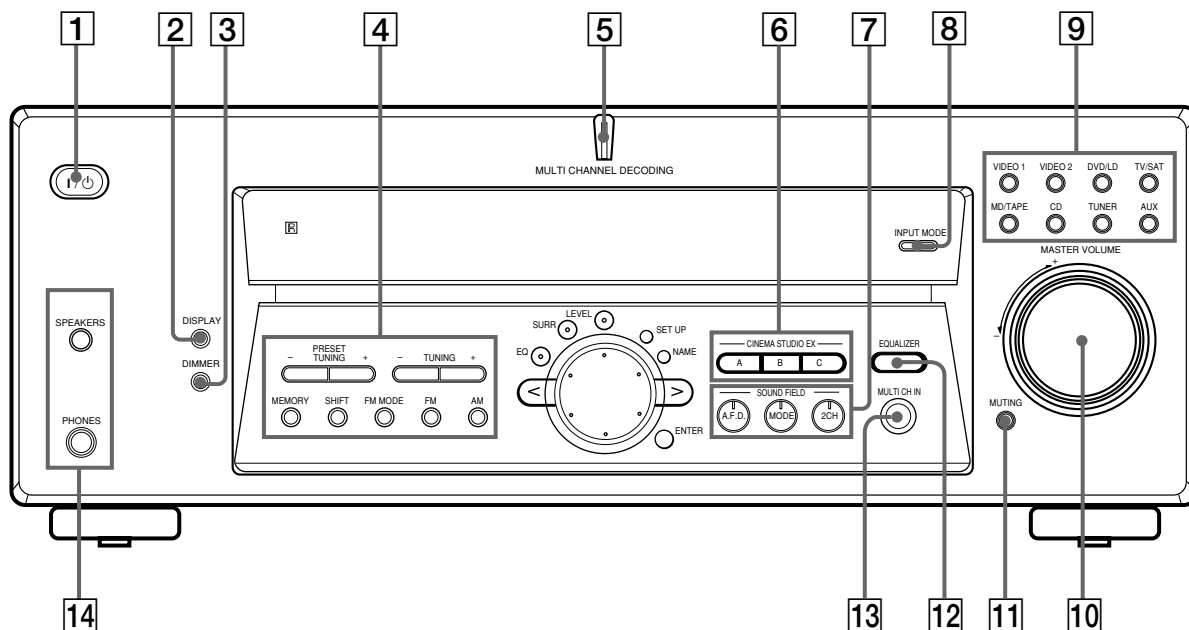

- 4** The following buttons operate the built-in tuner. For details, see “Receiving Broadcasts” starting from page 38.

PRESET TUNING +/- buttons

Scan all preset stations.

TUNING +/- buttons

Scan all the available radio stations.

MEMORY button

Press to memorize a preset station.

SHIFT button

Selects a memory page for preset stations.

FM MODE button

If “STEREO” flashes in the display and the FM stereo reception is poor, press this button. You will not have the stereo effect but the sound is improved.

FM button

Selects the FM band.

AM button

Selects the AM band.

- 5** **MULTI CHANNEL DECODING indicator**

This indicator lights up when the unit is decoding signals recorded in a multi channel format.

- 6** Use the CINEMA STUDIO EX buttons to enjoy the CINEMA STUDIO EX sound effects.

A/B/C buttons

Press to activate the CINEMA STUDIO EX A, B or C sound field (page 29).

- 7** Use the SOUND FIELD buttons to enjoy surround sound. For details, see “Enjoying Surround Sound” starting from page 27.

A.F.D. button / indicator

Press to set the receiver to automatically detect the type of audio signal being input and perform proper decoding (if necessary).

MODE button / indicator

Press to activate the sound field selection mode (page 28).

2CH button / indicator

Press to output sound from only the front (left and right) speakers.

8 INPUT MODE button

Press to select the input mode for your digital components (DVD/LD, TV/SAT and MD/TAPE). Each press switches the input mode of the currently selected component.

Select	To
AUTO	Give priority to digital signals when there are both digital and analog connections. If there are no digital signals, analog is selected
DIGITAL (OPTICAL)	Specify the digital audio signals input to the DIGITAL OPTICAL input jacks
DIGITAL (COAXIAL)	Specify the digital audio signals input to the DIGITAL COAXIAL input jacks (DVD/LD only)
ANALOG	Specify the analog audio signals input to the AUDIO IN (L and R) jacks

Note

If 96 kHz digital signal is input, the EQ, sound field and surround parameters do not function.

9 Function buttons

Press one of the buttons to select the component you want to use.

To select	Press
VCR	VIDEO 1 or VIDEO 2
DVD or LD player	DVD/LD
TV or satellite tuner	TV/SAT
MD or Tape deck	MD/TAPE
CD player	CD
Built in tuner	TUNER
An audio component	AUX

After selecting the component, turn on the component you selected and play the program source.

- After selecting VCR, DVD player, or LD player, turn on the TV and set the TV's video input to match the component you selected.

10 MASTER VOLUME control

After turning on the component you selected, rotate to adjust the volume.

11 MUTING button

Press to mute the sound. MUTING appears in the display when the sound is muted.

12 EQUALIZER button

Press to turn the equalizer on or off. The EQ indicator lights up when the equalizer is turned on. When you adjust the equalizer using the EQ parameters (page 36), the settings are stored automatically and can be reproduced whenever you turn on the equalizer.

- The equalizer is not compatible with 96 kHz digital audio signals and during MULTI CH IN input.

When you want to listen to an analog source without any digital processing

Do the following to bypass the sound field, and equalizer circuits.

- 1 Press 2CH
- 2 Press EQ to turn off the EQ indicator.

The result will be a sound that is highly faithful to the program source.

13 MULTI CH IN button

Press to enjoy the audio source connected to the MULTI CH IN jacks with the video from the selected component. Press again to cancel MULTI CH IN.

- When the MULTI CH IN is selected, equalizer, and sound field effects do not function.

14 SPEAKERS button

Press SPEAKERS button to ON.

PHONES jack

Connects headphones.

- When you connect the headphones, no sound will come from the speakers.

Front Panel Parts Description

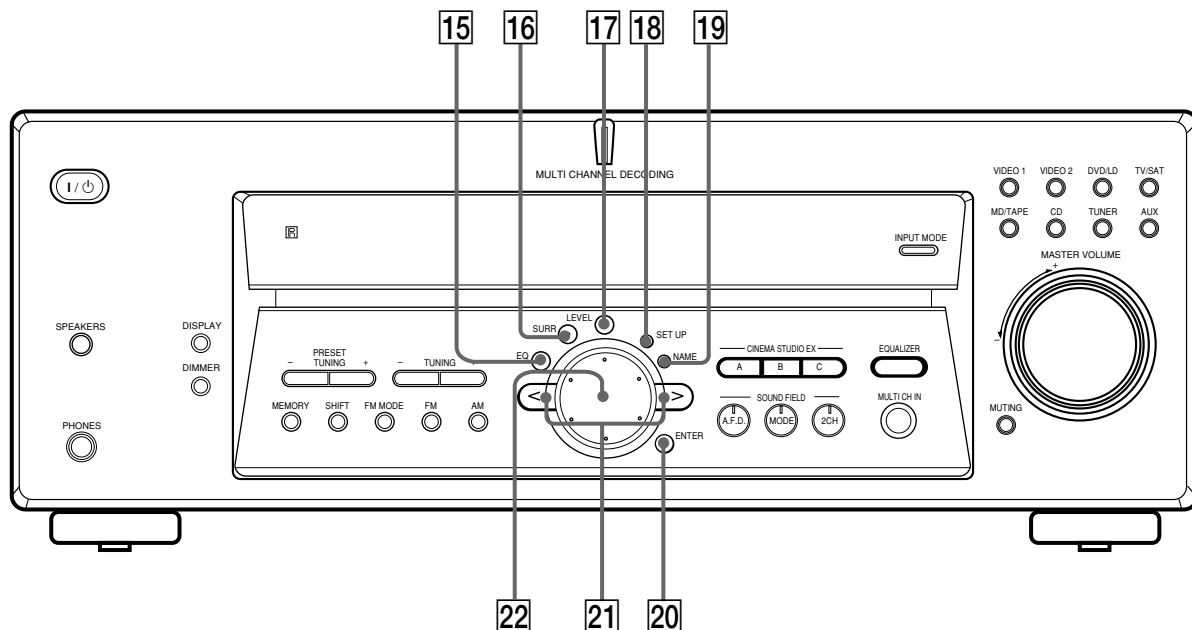

15 EQ button

Press to activate the equalizer parameters (page 36). The indicator on the button lights up and you can adjust the various equalizer parameters.

16 SURR button

Press to activate the surround parameters (page 34). The indicator on the button lights up and you can adjust the various surround parameters (effect level, wall type, etc.).

17 LEVEL button

Press to activate the speaker level parameters (page 35). The indicator on the button lights up and you can adjust the various speaker level parameters (front balance, surround balance, etc.).

18 SET UP button

Press to activate the setup mode, then use the cursor buttons (21) to select any of the following indications. You can then make various settings using the jog dial (22).

When you select	You can
Speaker type	Specify the type of speakers. (page 17)
Speaker setup	Specify the front, center, surround speaker sizes, the surround speaker position, and whether or not you are using a sub woofer. (page 17)

When you select

You can

Speaker Distance

Specify the front, center, and surround speaker distances. (page 19)

MULTI CH IN video input

Specify the video input to be used with the audio signals from the MULTI CH IN jacks. (page 45)

Dimmer range

Specify the display to turn off when you press the DIMMER button several times. (page 45)

19 NAME button

Press to activate the name function and enter names for preset stations and program sources (page 43).

20 ENTER button

Press to enter individual characters for the preset station and program source names.

21 Cursor buttons (</>)

Press to select various speaker level, surround, and equalizer parameters (etc.).

22 Jog dial

Turn to adjust the selected speaker level, surround, and equalizer parameters (etc.).

Enjoying Surround Sound

This chapter describes how to set up the receiver to enjoy surround sound. You can enjoy multi channel surround when playing back software encoded with Dolby Digital or DTS.

You can take advantage of surround sound simply by selecting one of the receiver's pre-programmed sound modes. They bring the exciting and powerful sound of movie theaters and concert halls into your home. You can also customize the sound modes to obtain the sound you desire by changing the various surround parameters. The receiver contains a variety of different sound modes. The cinema sound modes are designed for use when playing back movie software (DVD, LD, etc.) encoded with multi channel surround sound or Dolby Pro Logic. In addition to decoding the surround sound, some of these modes also provide sound effects commonly found in movie theaters.

The virtual sound modes contain compelling applications of the Sony Digital Cinema Sound digital signal processing technology. They shift the sound away from the actual speaker locations to simulate the presence of several "virtual" speakers.

The music (etc.) sound modes are designed for use with standard audio sources and TV broadcasts. They add reverberation to the source signal to make you feel as if you were in a concert hall or stadium (etc.). Use these sound modes with two-channel sources like CD and stereo broadcasts of sports programs or musical concerts. For more information about the sound modes, see pages 29 - 31.

A.F.D.

The "Auto Format Decoding" sound mode presents the sound exactly as it was encoded, without adding any reverberation (etc.).

To fully enjoy surround sound, you must register the number and location of your speakers. See "Multi-Channel Surround setup" starting on page 17 to set the speaker parameters before enjoying surround sound.

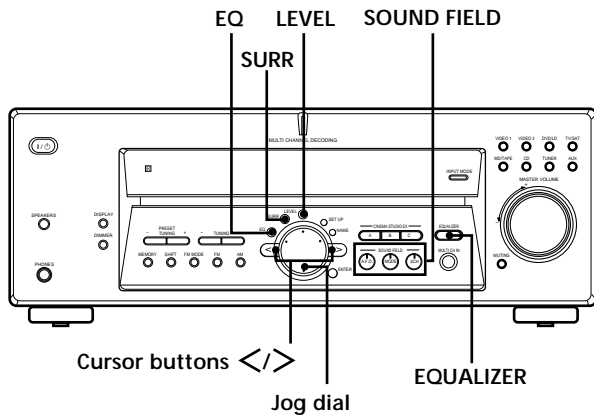

Brief descriptions of buttons used to enjoy surround sound

- LEVEL button:** Press to customize the level parameters.
- SURR button:** Press to customize the surround parameters in the current sound field.
- EQ button:** Press to customize the equalizer parameters in the current sound field.
- Cursor buttons (</>):** Use to select parameters after pressing the LEVEL, SURR, EQ or SET UP buttons.
- Jog dial:** Use to adjust parameters and select sound fields (etc.).
- SOUND FIELD buttons:**
 - A.F.D. button:** Press to set the receiver to automatically detect the type of audio signal being input and perform proper decoding (if necessary).
 - MODE button:** Press to activate the sound field selection mode.
 - 2CH button:** Press to output sound from only the front (left and right) speakers.
- EQUALIZER button:** Turns the equalizer effect on or off.

Selecting a Sound Field

You can enjoy surround sound simply by selecting one of the pre-programmed sound fields according to the program you want to listen to.

- 1 Press MODE.**
The current sound field is indicated in the display.
- 2 Turn the jog dial or press the cursor buttons (< or >) to select the sound field you want.**
See the table starting on page 29 for information on each sound field.



To turn the sound field off

Press A.F.D. or 2CH (page 24).

 The receiver memorizes the last sound field selected for each program source (Sound Field Link)

Whenever you select a program source, the sound field that was last applied is automatically applied again. For example, if you listen to CD with SMALL HALL as the sound field, change to a different program source, then return to CD, SMALL HALL will be applied again. With the tuner, sound fields are memorized separately for AM, FM, and all preset stations.

 You can identify Dolby Surround-encoded software by looking at the packaging

Dolby Digital discs are labeled with the  logo, and Dolby Surround encoded programs are labeled with the  logo.

Sound field information

Sound field	Effect	Notes
NORM. SURR. (NORMAL SURROUND)	Software with multi channel surround audio signals is played according to the way it was recorded. Software with two channel audio signals, is decoded with Dolby Pro Logic to create surround effects.	
C. ST. EX A (CINEMA STUDIO EX. A) ¹⁾²⁾ (Press CINEMA STUDIO EX. A button)	Reproduces the sound characteristics of Sony Pictures Entertainment's classic editing studio by using the 3D sound imaging of V.M.DIMENS. (page 30) to create 5 sets of virtual speakers surrounding the listener from a single pair of actual surround speakers.	This is a standard mode, great for watchiÆg most any type of movie.
C. ST. EX B (CINEMA STUDIO EX. B) ¹⁾²⁾ (Press CINEMA STUDIO EX. B button)	Reproduces the sound characteristics of Sony Pictures Entertainment's mixing studio which is one of the most up-to-date facilities in Hollywood. The 3D sound imaging of V.M.DIMENS. (page 30) is used to create 5 sets of virtual speakers surrounding the listener from a single pair of actual surround speakers.	This mode is ideal for watching science-fiction or action movies with lots of sound effects.
C. ST. EX C (CINEMA STUDIO EX. C) ¹⁾²⁾ (Press CINEMA STUDIO EX. C button)	Reproduces the sound characteristics of Sony Pictures Entertainment's BGM recording studio by using the 3D sound imaging of V.M.DIMENS (page 30) to create 5 sets of virtual speakers surrounding the listener from a single pair of actual surround speakers.	This mode is ideal for watching musicals or classic films where music is featured in the soundtrack.
S. C. EX A (SEMI CINEMA STUDIO EX. A) ¹⁾	Reproduces the sound characteristics of Sony Pictures Entertainment's classic editing studio using the 3D sound imaging of V. SEMI M.D. (page 30) to create 5 set of virtual speakers surrounding the listener from the sound of the front speakers (without using actual surround speakers).	
S. C. EX B (SEMI CINEMA STUDIO EX. B) ¹⁾	Reproduces the sound characteristics of Sony Pictures Entertainment's mixing studio which is one of the most up-to-date facilities in Hollywood. The 3D sound imaging of V. SEMI M.D. (page 30) is used to create 5 sets of virtual speakers surrounding the listener from the sound of the front speakers (without using actual surround speakers).	
S. C. EX C (SEMI CINEMA STUDIO EX. C) ¹⁾	Reproduces the sound characteristics of Sony Pictures Entertainment's BGM recording studio using the 3D sound imaging of V.SEMI M.D. (page 30) to create 5 sets of virtual speakers surrounding the listener from the sound of the front speakers (without using actual surround speakers).	

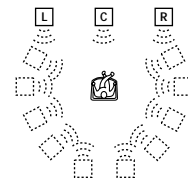

¹⁾ "VIRTUAL" sound field: Sound field with virtual speakers.

²⁾ You can select by pressing the buttons on the front panel.

Selecting a Sound Field

Sound field information

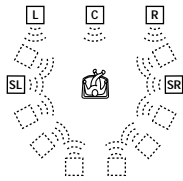
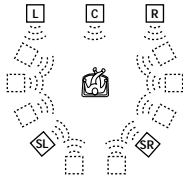
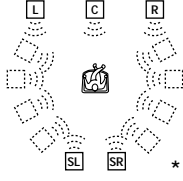
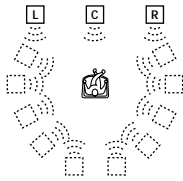
Sound field	Effect	Notes
V. M.DIMENS. ¹⁾ (VIRTUAL MULTI DIMENSION)	Uses 3D sound imaging to create an array of virtual surround speakers positioned higher than the listener from a single pair of actual surround speakers. This mode creates four sets of virtual speakers surround the listener at approximately a 30° angle of elevation.	 <p>SIDE**</p>  <p>MIDDLE**</p>  <p>BEHIND**</p> <p>** See page 18</p>
V. SEMI M.D. ¹⁾ (VIRTUAL SEMI-MULTI DIMENSION)	Uses 3D sound imaging to create virtual surround speakers from the sound of the front speakers without using actual surround speakers. This mode creates five sets of virtual speakers surround the listener at a 30° angle of elevation.	
S. HALL (SMALL HALL)	Reproduces the acoustics of a small rectangular concert hall.	Ideal for musicals and opera.
L. HALL (LARGE HALL)	Reproduces the acoustics of a large rectangular concert hall.	
JAZZ (JAZZ CLUB)	Reproduces the acoustics of a jazz club.	Great for rock or pop music.
L. HOUSE (LIVE HOUSE)	Reproduces the acoustics of a 300-seat live house.	
GAME	Obtains maximum audio impact from video game software.	Be sure to set the game machine to stereo mode when using game software with stereo sound capabilities.

¹⁾ "VIRTUAL" sound field: Sound field with virtual speakers.

Notes

- When you select S. HALL, L. HALL, JAZZ and L. HOUSE, no sound is output from the sub woofer if you select NORM. SP. and your front speaker size is set to "LARGE". However, sound will be output from the sub woofer if the digital input signal contains L.F.E. signals.
- The effects provided by the virtual speakers may cause increased noise in the play back signal.
- When listening to sound fields that employ the virtual speakers, you will not be able to hear any sound coming directly from the surround speakers.

Use the buttons on the front panel to operate the following modes

<p>A.F.D. AUTO FORMAT DECODING (Press the A.F.D. button)</p>	<p>Automatically detects the type of audio signal being input (Dolby Digital, Dolby Pro Logic, or standard two channel stereo) and performs the proper decoding if necessary. This mode presents the sound as it was recorded/encoded, without adding any effects.</p>	<p>You can use this mode as a reference. Set the EQUALIZER to OFF while using this mode to hear the source sound exactly as it was recorded.</p>
<p>2 CH ST. 2 CHANNEL (Press the 2CH button)</p>	<p>Outputs the sound from the front left and right speakers only. Standard two channel (stereo) sources completely bypass the sound field processing. Multi channel surround formats are downmixed to two channels.</p>	<p>This allows you to play any source using only the front left and right speakers.</p>

Notes

- No sound is output from the sub woofer when the 2 CHANNEL mode is selected. To listen to two channel (stereo) sources using the front left and right speakers and a sub woofer, use the AUTO FORMAT DECODING mode.
- When you select "Micro Satellite Speaker", internal sound processor will automatically redirect bass sound to subwoofer. If you want to listen to two channel (stereo) sources under this setting, we recommend that you choose AUTO FORMAT DECODING mode so that you can take advantage of your subwoofer to get back correct bass signal.

Understanding the Multi-Channel Surround Displays

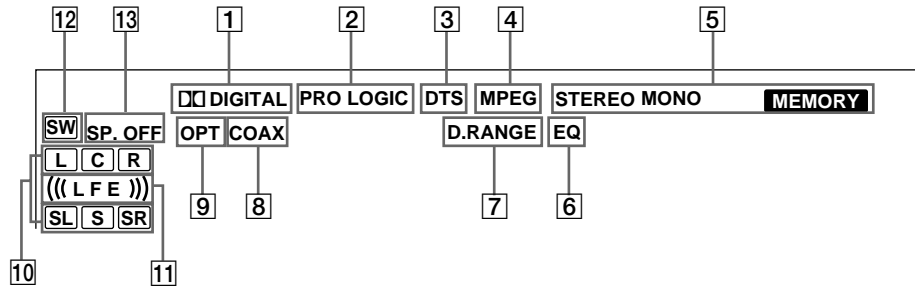

1 DIGITAL

This indicator lights up when the receiver is decoding signals recorded in the Dolby Digital format.

2 PRO LOGIC

Lights up when the receiver applies Pro Logic processing to two channel signals in order to output the center and surround channel signals.*

* However, this indicator does not light if the center and surround speakers are set to "NO", or the SPEAKERS button is set to OFF and the A.F.D. or NORMAL SURROUND sound fields are selected.

3 DTS

Lights up when DTS signals are input.

Note

When playing a DTS format disc, be sure that you have made digital connections and that INPUT MODE is NOT set to ANALOG (see **8** on page 25).

4 MPEG

Lights up when MPEG** signals are input.

**Supports MPEG 2 channel only.

5 Tuner indicators

These indicators light up when using the receiver to tune in radio stations, etc. See pages 38 – 41 for tuner operations.

6 EQ

Lights when the equalizer functions.

7 D. RANGE

Lights up when dynamic range compression is active. See page 36 to adjust the dynamic range compression.

8 COAX

Lights up when the source signal is a digital signal being input through the COAX terminal.

9 OPT

Lights up when the source signal is a digital signal being input through the OPT terminal.

10 Play back channel indicators

The letters light up to indicate the channels being played back.

L: Front Left

R: Front Right

C: Center (monaural)

SL: Left Surround

SR: Right Surround

S: Surround (monaural or the surround components obtained by Pro Logic processing)

The boxes around the letters light up to indicate the speakers used to playback the channels.

See the next page for details regarding the playback channel indicators.

11 ((LFE))

((LFE)) will light up when the disc being played contains the LFE (Low Frequency Effect) channel and when the sound of the LFE channel signal is actually being reproduced.

12 SW

Lights up when sub woofer selection is set to "YES" (page 19) and the audio signal is output from the SUB WOOFER jack(s).

13 SP. OFF

Lights up when headphone is inserted or the SPEAKERS button is set to OFF.

Source sound displays

The letters (L, C, R, etc.) indicate the source sound. The box around the letters varies to show how the receiver downmixes the source sound (based on the speakers settings). When using music sound modes such as SMALL HALL or JAZZ CLUB, the receiver adds reverberation based on the source sound.

The following table shows how the indicators light up when using AUTO FORMAT DECODING mode.

Although the table below shows almost all of the configurations available from multi channel surround signals, the ones marked “☆” are the most common.

Recording Format (Front/Surround)	Input Channel Display	Source sound and Output Channel Display			
		All speakers present	Surround speakers absent	Center speaker absent	Surround/center speakers absent
1/0	DOLBY DIGITAL [1/0]	<input checked="" type="checkbox"/> DIGITAL <input type="checkbox"/> C	<input checked="" type="checkbox"/> DIGITAL <input type="checkbox"/> C	<input checked="" type="checkbox"/> DIGITAL <input type="checkbox"/> c <input type="checkbox"/>	<input checked="" type="checkbox"/> DIGITAL <input type="checkbox"/> c <input type="checkbox"/>
	DTS [1/0]	<input type="checkbox"/> dts <input type="checkbox"/> C	<input type="checkbox"/> dts <input type="checkbox"/> C	<input type="checkbox"/> dts <input type="checkbox"/> c <input type="checkbox"/>	<input type="checkbox"/> dts <input type="checkbox"/> c <input type="checkbox"/>
2/0*	DOLBY DIGITAL [2/0]	<input checked="" type="checkbox"/> DIGITAL <input type="checkbox"/> L <input type="checkbox"/> R	<input checked="" type="checkbox"/> DIGITAL <input type="checkbox"/> L <input type="checkbox"/> R	<input checked="" type="checkbox"/> DIGITAL <input type="checkbox"/> L <input type="checkbox"/> R	<input checked="" type="checkbox"/> DIGITAL <input type="checkbox"/> L <input type="checkbox"/> R
	DTS [2/0]	<input type="checkbox"/> dts <input type="checkbox"/> L <input type="checkbox"/> R	<input type="checkbox"/> dts <input type="checkbox"/> L <input type="checkbox"/> R	<input type="checkbox"/> dts <input type="checkbox"/> L <input type="checkbox"/> R	<input type="checkbox"/> dts <input type="checkbox"/> L <input type="checkbox"/> R
3/0	DOLBY DIGITAL [3/0]	<input checked="" type="checkbox"/> DIGITAL <input type="checkbox"/> L <input type="checkbox"/> C <input type="checkbox"/> R	<input checked="" type="checkbox"/> DIGITAL <input type="checkbox"/> L <input type="checkbox"/> C <input type="checkbox"/> R	<input checked="" type="checkbox"/> DIGITAL <input type="checkbox"/> L <input type="checkbox"/> c <input type="checkbox"/> R	<input checked="" type="checkbox"/> DIGITAL <input type="checkbox"/> L <input type="checkbox"/> c <input type="checkbox"/> R
	DTS [3/0]	<input type="checkbox"/> dts <input type="checkbox"/> L <input type="checkbox"/> C <input type="checkbox"/> R	<input type="checkbox"/> dts <input type="checkbox"/> L <input type="checkbox"/> C <input type="checkbox"/> R	<input type="checkbox"/> dts <input type="checkbox"/> L <input type="checkbox"/> c <input type="checkbox"/> R	<input type="checkbox"/> dts <input type="checkbox"/> L <input type="checkbox"/> c <input type="checkbox"/> R
2/1	DOLBY DIGITAL [2/1]	<input checked="" type="checkbox"/> DIGITAL <input type="checkbox"/> L <input type="checkbox"/> R <input type="checkbox"/> S	<input checked="" type="checkbox"/> DIGITAL <input type="checkbox"/> L <input type="checkbox"/> R <input type="checkbox"/> S	<input checked="" type="checkbox"/> DIGITAL <input type="checkbox"/> L <input type="checkbox"/> R <input type="checkbox"/> S	<input checked="" type="checkbox"/> DIGITAL <input type="checkbox"/> L <input type="checkbox"/> R <input type="checkbox"/> S
	DTS [2/1]	<input type="checkbox"/> dts <input type="checkbox"/> L <input type="checkbox"/> R <input type="checkbox"/> S	<input type="checkbox"/> dts <input type="checkbox"/> L <input type="checkbox"/> R <input type="checkbox"/> S	<input type="checkbox"/> dts <input type="checkbox"/> L <input type="checkbox"/> R <input type="checkbox"/> S	<input type="checkbox"/> dts <input type="checkbox"/> L <input type="checkbox"/> R <input type="checkbox"/> S
3/1	DOLBY DIGITAL [3/1]	<input checked="" type="checkbox"/> DIGITAL <input type="checkbox"/> L <input type="checkbox"/> C <input type="checkbox"/> R <input type="checkbox"/> S	<input checked="" type="checkbox"/> DIGITAL <input type="checkbox"/> L <input type="checkbox"/> C <input type="checkbox"/> R <input type="checkbox"/> S	<input checked="" type="checkbox"/> DIGITAL <input type="checkbox"/> L <input type="checkbox"/> c <input type="checkbox"/> R <input type="checkbox"/> S	<input checked="" type="checkbox"/> DIGITAL <input type="checkbox"/> L <input type="checkbox"/> c <input type="checkbox"/> R <input type="checkbox"/> S
	DTS [3/1]	<input type="checkbox"/> dts <input type="checkbox"/> L <input type="checkbox"/> C <input type="checkbox"/> R <input type="checkbox"/> S	<input type="checkbox"/> dts <input type="checkbox"/> L <input type="checkbox"/> C <input type="checkbox"/> R <input type="checkbox"/> S	<input type="checkbox"/> dts <input type="checkbox"/> L <input type="checkbox"/> c <input type="checkbox"/> R <input type="checkbox"/> S	<input type="checkbox"/> dts <input type="checkbox"/> L <input type="checkbox"/> c <input type="checkbox"/> R <input type="checkbox"/> S
2/2	DOLBY DIGITAL [2/2]	<input checked="" type="checkbox"/> DIGITAL <input type="checkbox"/> L <input type="checkbox"/> R <input type="checkbox"/> SL <input type="checkbox"/> SR	<input checked="" type="checkbox"/> DIGITAL <input type="checkbox"/> L <input type="checkbox"/> R <input type="checkbox"/> SL <input type="checkbox"/> SR	<input checked="" type="checkbox"/> DIGITAL <input type="checkbox"/> L <input type="checkbox"/> R <input type="checkbox"/> SL <input type="checkbox"/> SR	<input checked="" type="checkbox"/> DIGITAL <input type="checkbox"/> L <input type="checkbox"/> R <input type="checkbox"/> SL <input type="checkbox"/> SR
	DTS [2/2]	<input type="checkbox"/> dts <input type="checkbox"/> L <input type="checkbox"/> R <input type="checkbox"/> SL <input type="checkbox"/> SR	<input type="checkbox"/> dts <input type="checkbox"/> L <input type="checkbox"/> R <input type="checkbox"/> SL <input type="checkbox"/> SR	<input type="checkbox"/> dts <input type="checkbox"/> L <input type="checkbox"/> R <input type="checkbox"/> SL <input type="checkbox"/> SR	<input type="checkbox"/> dts <input type="checkbox"/> L <input type="checkbox"/> R <input type="checkbox"/> SL <input type="checkbox"/> SR
3/2	☆ DOLBY DIGITAL [3/2]	<input checked="" type="checkbox"/> DIGITAL <input type="checkbox"/> L <input type="checkbox"/> C <input type="checkbox"/> R <input type="checkbox"/> SL <input type="checkbox"/> SR	<input checked="" type="checkbox"/> DIGITAL <input type="checkbox"/> L <input type="checkbox"/> C <input type="checkbox"/> R <input type="checkbox"/> SL <input type="checkbox"/> SR	<input checked="" type="checkbox"/> DIGITAL <input type="checkbox"/> L <input type="checkbox"/> c <input type="checkbox"/> R <input type="checkbox"/> SL <input type="checkbox"/> SR	<input checked="" type="checkbox"/> DIGITAL <input type="checkbox"/> L <input type="checkbox"/> c <input type="checkbox"/> R <input type="checkbox"/> SL <input type="checkbox"/> SR
	☆ DTS [3/2]	<input type="checkbox"/> dts <input type="checkbox"/> L <input type="checkbox"/> C <input type="checkbox"/> R <input type="checkbox"/> SL <input type="checkbox"/> SR	<input type="checkbox"/> dts <input type="checkbox"/> L <input type="checkbox"/> C <input type="checkbox"/> R <input type="checkbox"/> SL <input type="checkbox"/> SR	<input type="checkbox"/> dts <input type="checkbox"/> L <input type="checkbox"/> c <input type="checkbox"/> R <input type="checkbox"/> SL <input type="checkbox"/> SR	<input type="checkbox"/> dts <input type="checkbox"/> L <input type="checkbox"/> c <input type="checkbox"/> R <input type="checkbox"/> SL <input type="checkbox"/> SR
2/0**	☆ DOLBY DIGITAL [2/0]	<input checked="" type="checkbox"/> DIGITAL <input type="checkbox"/> L <input type="checkbox"/> C <input type="checkbox"/> R <input type="checkbox"/> PRO LOGIC <input type="checkbox"/> S	<input checked="" type="checkbox"/> DIGITAL <input type="checkbox"/> L <input type="checkbox"/> C <input type="checkbox"/> R <input type="checkbox"/> PRO LOGIC <input type="checkbox"/> S	<input checked="" type="checkbox"/> DIGITAL <input type="checkbox"/> L <input type="checkbox"/> c <input type="checkbox"/> R <input type="checkbox"/> PRO LOGIC <input type="checkbox"/> S	<input checked="" type="checkbox"/> DIGITAL <input type="checkbox"/> L <input type="checkbox"/> R <input type="checkbox"/> PRO LOGIC <input type="checkbox"/> S
	☆ DOLBY PRO LOGIC	<input type="checkbox"/> PRO LOGIC <input type="checkbox"/> L <input type="checkbox"/> C <input type="checkbox"/> R <input type="checkbox"/> S	<input type="checkbox"/> PRO LOGIC <input type="checkbox"/> L <input type="checkbox"/> C <input type="checkbox"/> R <input type="checkbox"/> S	<input type="checkbox"/> PRO LOGIC <input type="checkbox"/> L <input type="checkbox"/> c <input type="checkbox"/> R <input type="checkbox"/> S	<input type="checkbox"/> PRO LOGIC <input type="checkbox"/> L <input type="checkbox"/> R <input type="checkbox"/> S
	☆ PCM XX kHz***	<input type="checkbox"/> L <input type="checkbox"/> R	<input type="checkbox"/> L <input type="checkbox"/> R	<input type="checkbox"/> L <input type="checkbox"/> R	<input type="checkbox"/> L <input type="checkbox"/> R

* Signals with Dolby Surround encoded flag OFF

** Signals with Dolby Surround encoded flag ON

*** The sampling rate is displayed.

Notes

- The receiver performs Pro Logic decoding and the display conforms to 2/0** when using the following movie sound modes with 2/0* or STEREO PCM format signals. (C. ST. EX A, B, C, S. C. EX A, B, C, V.M.DIMENS. and V. SEMI M.D.)
- When using music sound modes such as SMALL HALL or JAZZ CLUB with standard audio formats e.g., PCM, the receiver creates surround signals from the front L and R signals. In this case, sound is output from the surround speakers, but output channel indicators for the surround speakers do not light.

Customizing Sound Fields

By adjusting the surround parameters and the tone characteristics of the front speakers, you can customize the sound fields to suit your particular listening situation.

Once you customize a sound field, the changes are stored in memory indefinitely (unless the receiver is unplugged for about one week). You can change a customized sound field any time by making new adjustments to the parameters.

See the table on page 37 for the parameters available in each sound field.

To get the most from multi channel surround sound

Position your speakers and do the procedures described in “Multi Channel Surround Setup” starting on page 17 before you customize a sound field.

Adjusting the surround parameters

The SURR menu contains parameters that let you customize various aspects of the current sound field. The settings available in this menu are stored individually for each sound field.

- 1 Start playing a program source encoded with multi channel surround sound.**
- 2 Press SURR.**
The button lights up and the first parameter is displayed.
- 3 Press the cursor buttons (< or >) to select the parameter you want to adjust.**
- 4 Turn the jog dial to select the setting you want.**
The setting is stored automatically.

Effect level (EFFECT)

Initial setting : (depends on sound mode)

This parameter lets you adjust the “presence” of the current surround effect.

Wall type

Initial setting : WALL MID

When sound is reflected off soft material, such as a curtain, the high frequency elements are reduced. A hard wall is highly reflective and does not significantly affect the frequency response of the reflected sound. This parameter lets you control the level of the high frequencies to alter the sonic character of your listening environment by simulating a softer (S) or harder (H) wall.

- The wall type can be adjusted from WALL S. 1 ~ WALL S. 8 (soft) to WALL H. 1 ~ WALL H. 8 (hard) in 17 steps.
- The midpoint WALL MID designates a neutral wall (made of wood).

Reverberation

Initial setting : REVB. MID

Before sound reaches our ears, it is reflected (reverberated) many times between the left and right walls, ceiling, and floor. In a large room, sound takes more time to bounce from one surface to another than in a smaller room. This parameter lets you control the spacing of the early reflections to simulate a sonically larger (L) or smaller (S) room.

- The reverberation can be adjusted from REVB. S. 1 ~ REVB. S. 8 (short) to REVB. L. 1 ~ REVB. L. 8 (long) in 17 steps.
- The midpoint REVB. MID designates a standard room with no adjustment.

Screen depth

Initial setting : SCR. MID

In a movie theater, sound seems to come from inside the image reflected on the movie screen. This parameter allows you to create the same sensation in your listening room by shifting the sound of the front speakers “into” the screen.

- The screen depth can be set to SCR. OFF, SCR. MID, or SCR. DEEP.
- SCR. DEEP provides the greatest amount of screen depth.

Adjusting the level parameters

The LEVEL menu contains parameters that let you adjust the balance and speaker volumes of each speaker. The settings available in this menu are applied to all sound fields.

- 1 Start playing a program source encoded with multi channel surround sound.
- 2 Press LEVEL.
The button lights up and the first parameter is displayed.
- 3 Press the cursor buttons (< or >) to select the parameter you want to adjust.
- 4 Turn the jog dial to select the setting you want.
The setting is stored automatically.

*Front balance (◀L▶ ▶R▶)

Initial setting : BALANCE

Lets you adjust the balance between the front left and right speakers.

- The balance can be adjusted ± 8 steps.
- These settings can also be adjusted using the supplied remote. See "Adjusting the speaker volume" (page 20).

*Surround balance (◀SL▶ ▶SR▶)

Initial setting : BALANCE

Lets you adjust the balance between the surround left and right speakers.

- The balance can be adjusted ± 8 steps.
- These settings can also be adjusted using the supplied remote. See "Adjusting the speaker volume" (page 20).

*Center level

Initial setting : CTR 0 dB

Lets you adjust the level of the center speaker.

- The level can be adjusted in 1 dB steps from -6 dB to +6 dB.

*Surround level

Initial setting : SURR 0 dB

Lets you adjust level of the surround (left and right) speakers.

- The level can be adjusted in 1 dB steps from -6 dB to +6 dB.

*Sub woofer level

Initial setting : S.W. 0 dB

Lets you adjust the level of the sub woofer.

- The level can be adjusted in 1 dB steps from -6 dB to +6 dB.

* The parameters can be adjusted separately for MULTI CHIN.

Low Frequency Effect

Initial setting : L.F.E. 0 dB

This parameter lets you attenuate the level of the LFE (Low Frequency Effect) channel output from the sub woofer without affecting the level of the bass frequencies sent to the sub woofer from the front, center or surround channels via the bass redirection circuitry.

- The level can be adjusted in 1 dB steps from -20.0 dB to 0 dB (line level). 0 dB outputs the full LFE signal at the mix level determined by the recording engineer.
- Selecting OFF mutes the sound of the LFE channel from the sub woofer. However, the low frequency sounds of the front, center, or surround speakers are output from the sub woofer according to the settings made for each speaker in the speaker setup (page 17).

Dynamic range compressor (D. RANGE)

Initial setting : COMP. OFF

Lets you compress the dynamic range of the sound track. This may be useful when you want to watch movies at low volumes late at night.

- COMP. OFF reproduces the sound track with no compression.
- COMP. STD reproduces the sound track with the dynamic range intended by the recording engineer.
- COMP. 0.1 ~ 0.9 allow you to compress the dynamic range in small steps to achieve the sound you want.
- COMP. MAX provides a dramatic compression of the dynamic range.

Note

Dynamic range compression is not possible with DTS sources.

About the Dynamic Range Compressor

This parameter allows you to compress the dynamic range of the soundtrack based on the dynamic range information included in the Dolby Digital signal. "COMP. STD" is standard compression, but because many sources have only light compression, you may not notice much difference when using COMP. 0.1~0.9. Therefore, we recommend using the "COMP. MAX" setting. This greatly compresses the dynamic range and allows you to view movies late at night at low volumes. Unlike analog limiters, the levels are predetermined and it provides a very natural compression.

Adjusting the equalizer

The EQ menu lets you adjust the equalization (low and high frequencies) of the front speakers. The equalizer settings are stored individually for each sound field.

- 1 Start playing a program source encoded with multi channel surround sound.
- 2 Press EQ.
The button lights up and the first parameter is displayed.
- 3 Press the cursor buttons (< or >) to select the parameter you want to adjust.
- 4 Turn the jog dial to select the setting you want.
The setting is stored automatically.

 You can turn off the equalization without erasing it
The equalization settings are stored separately for each sound field. Press the EQUALIZER button to turn the EQ indicator off.

Front speaker bass adjustment (Level/Frequency)

- ① Use the cursor buttons (</>) to select the level (dB) or frequency (Hz).
- ② Use the jog dial to adjust.
Repeat until you achieve the sound you desire.
 - The level can be adjusted ± 6 dB in 1 dB steps.
 - The frequency can be adjusted from 99 Hz to 1.0 kHz in 21 steps.

Front speaker treble adjustment (Level/Frequency)

Adjust as described in "Front speaker bass adjustment".

- The level can be adjusted ± 6 dB in 1 dB steps.
- The frequency can be adjusted from 1.0 kHz to 10 kHz in 23 steps.

Resetting customized sound fields to the factory settings

- 1 If the power is on, press I/⏻ to turn off the power.
- 2 Hold down MODE and press I/⏻.
"SF. CLR" appears in the display and all sound fields are reset at once.

Adjustable parameters for each sound field

	EFFECT LEVEL	WALL TYPE	REVERB TIME	SCREEN DEPTH	FRONT BAL.	SURR BAL.	CENTER LEVEL	SURR LEVEL	SUB WOOFER LEVEL	LFE MIX
2CH					●					●
A.F.D.					●	●	●	●	●	●
NORMAL SURROUND					●	●	●	●	●	●
CINEMA STUDIO EX. A	●			●	●	●	●	●	●	●
CINEMA STUDIO EX. B	●			●	●	●	●	●	●	●
CINEMA STUDIO EX. C	●			●	●	●	●	●	●	●
SEMI CINEMA STUDIO EX. A	●			●	●		●		●	●
SEMI CINEMA STUDIO EX. B	●			●	●		●		●	●
SEMI CINEMA STUDIO EX. C	●			●	●		●		●	●
V. MULTI DIMENSION					●	●	●	●	●	●
V. SEMI-M. DIMENSION					●		●		●	●
SMALL HALL	●	●	●		●	●	●	●	●	●
LARGE HALL	●	●	●		●	●	●	●	●	●
JAZZ CLUB	●	●	●		●	●	●	●	●	●
LIVE HOUSE	●	●	●		●	●	●	●	●	●
GAME	●	●	●		●	●	●	●	●	●
MULTI CH IN					●	●	●	●	●	

	D.RANGE COMP.	EQ
2CH	●	●
A.F.D.	●	●
NORMAL SURROUND	●	●
CINEMA STUDIO EX. A	●	●
CINEMA STUDIO EX. B	●	●
CINEMA STUDIO EX. C	●	●
SEMI CINEMA STUDIO EX. A	●	●
SEMI CINEMA STUDIO EX. B	●	●
SEMI CINEMA STUDIO EX. C	●	●
V. MULTI DIMENSION	●	●
V. SEMI-M. DIMENSION	●	●
SMALL HALL	●	●
LARGE HALL	●	●
JAZZ CLUB	●	●
LIVE HOUSE	●	●
GAME	●	●
MULTI CH IN		

Receiving Broadcasts

This chapter describes how to receive FM or AM broadcasts and how to preset selected stations.

You can tune in stations on this receiver in the following ways:

Direct Tuning

You can enter a frequency of the station you want directly by using the numeric buttons on the remote (see page 40).

Automatic Tuning

If you don't know the frequency of the station you want, you can let the receiver scan all available stations in your area (see page 40).

Preset Tuning

After you have tuned in stations using Direct Tuning or Automatic Tuning, you can preset them to the receiver (see page 41). Then you can tune in any of the stations directly by entering its 2-character code (see page 41). Up to 30 FM or AM stations can be preset. The receiver will also scan all the stations that you have preset (see page 41).

Before you begin, make sure you have:

- Connected an FM and AM antenna to the receiver (see page 5).

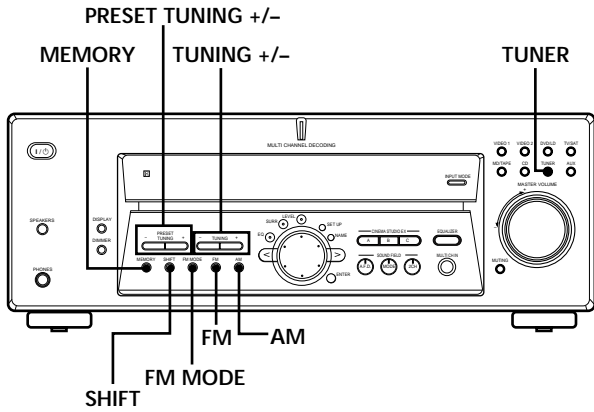

Brief descriptions of buttons used to receive broadcasts

PRESET TUNING +/- : Press to scan all preset radio stations.

TUNING +/-: Press to scan all available radio stations.

FM MODE: If “STEREO” flashes in the display and the FM stereo reception is poor, press this button to improve the sound. You will not be able to enjoy stereo effect but the sound will be less distorted.

Note
If “STEREO” does not appear at all even when the FM broadcast is received normally, press this button to turn on the “STEREO” indication.

FM: Press to select the FM band.

AM: Press to select the AM band.

MEMORY: Uses for memorizing preset stations.

SHIFT: Press to select a memory page (A, B, or C) for presetting radio stations or tuning to preset stations.

TUNER: Press to select the tuner.

On the remote:
D. TUNING: Press this button to enter a frequency directly using the numeric buttons.

Numeric buttons: Press to enter a numeric value when inputting the frequency directly, presetting radio stations, or tuning to preset stations.

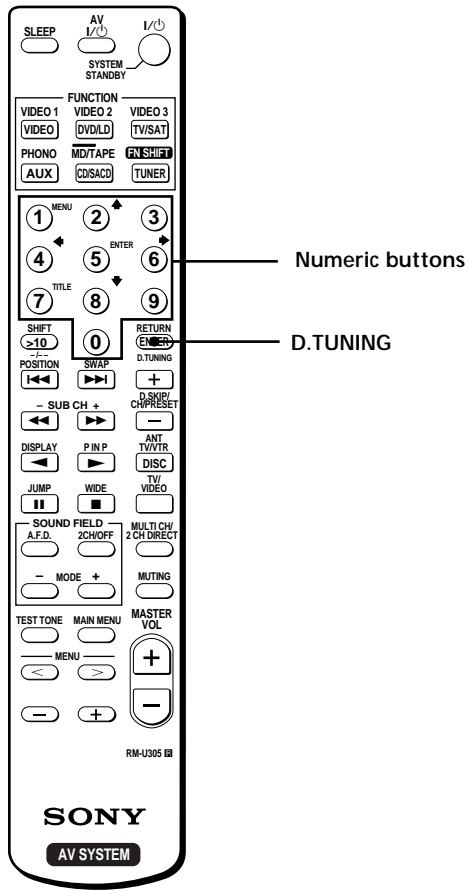

Direct Tuning

For details on the buttons used in this section, see “Brief descriptions of buttons used to receive broadcasts” on page 39.

- 1 Press TUNER.
The last received station is tuned in.
- 2 Press FM or AM to select the FM or AM band.
- 3 Press D.TUNING on the remote.
- 4 Press the numeric buttons on the remote to enter the frequency.

Example 1: FM 102.50 MHz

① → ② → ⑤ → ① → ②

Example 2: AM 1350 kHz

(You don't have to enter the last “0” when tuning interval is set to 10 kHz)

① → ③ → ⑤ → ①

If you cannot tune in a station and the entered numbers flash

Make sure you've entered the right frequency. If not, repeat Steps 3 and 4.

If the entered numbers still flash, the frequency is not used in your area.

- 5 If you've tuned in an AM station, adjust the direction of the AM loop antenna for optimum reception.
- 6 Repeat Steps 2 to 5 to receive other stations.



If you try to enter a frequency not covered by the tuning interval

The entered value is automatically rounded up or down.

The tuning scale for direct tuning differs depending on the area code as shown in the following table. For details on area codes, see page 3.

Area code	FM tuning scale	AM tuning scale
E2, E3, TW	50kHz	9kHz (can be changed to 10kHz)*
AU, CN, SP	50kHz	9kHz

* To change the AM tuning scale, see page 50.

Automatic Tuning

For details on the buttons used in this section, see “Brief descriptions of buttons used to receive broadcasts” on page 39.

- 1 Press TUNER.
The last received station is tuned in.
- 2 Press FM or AM to select the FM or AM band.
- 3 Press TUNING + or TUNING –.
Press the + button to scan from low to high; press the – button to scan from high to low.

When the receiver reaches either end of the band

Scanning is repeated in the same direction.

The receiver stops scanning whenever a station is received.

- 4 To continue scanning, press TUNING + or TUNING – again.

Preset Tuning

For details on the buttons used in this section, see “Brief descriptions of buttons used to receive broadcasts” on page 39.

Before tuning to preset stations, be sure to preset them by performing steps on “Presetting radio stations” below.

Presetting radio stations

- 1 Press **TUNER**.
The last received station is tuned in.
- 2 Tune in the station that you want to preset using **Direct Tuning**, or **Automatic Tuning** (page 40).
- 3 Press **MEMORY**.
“MEMORY” appears in the display for a few seconds. Do Steps 4 to 6 before “MEMORY” goes out.
- 4 Press **SHIFT** to select a memory page (A, B or C).
Each time you press **SHIFT**, the letter “A,” “B” or “C” appears in the display.
- 5 Select a preset number by pressing **PRESET TUNING +** or **PRESET TUNING -**.
If “MEMORY” goes out before you press the preset number, start again from Step 3.
- 6 Press **MEMORY** again to store the station.
If “MEMORY” goes out before you can store the station, start again from Step 3.
- 7 Repeat Steps 2 to 6 to preset another station.

To change a preset number to another station

Do Steps 1 to 6 to preset the new station to the number.

Note

If the AC power cord is disconnected for about one week, all the preset stations will be cleared from the receiver’s memory, and you will have to preset the stations again.

Tuning to preset stations

You can tune the preset stations either of the following two ways.

Scanning the preset stations

- 1 Press **TUNER**.
The last received station is tuned in.
- 2 Press **PRESET TUNING +** or **PRESET TUNING -** repeatedly to select the preset station you want. Each time you press the button, the receiver tunes in one preset station at a time, in the corresponding order and direction as follows:

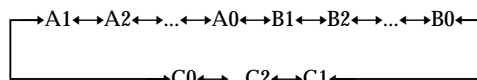

Using the preset codes

- 1 Press **TUNER**.
The last received station is tuned in.
- 2 Press **SHIFT** to select a memory page (A, B or C), then press the preset number of the station you want using the numeric buttons on the supplied remote.

Other Operations

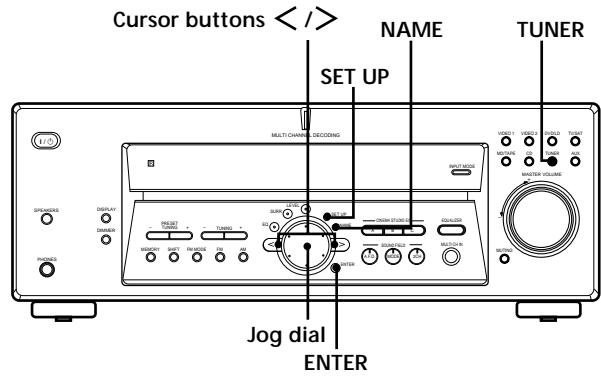

Brief descriptions of buttons that appear in this chapter

NAME button: Press to name preset stations or program sources.

Jog dial: Use to select characters when naming preset stations or program sources.

Cursor buttons (< / >): Use to move the cursor when naming preset stations or program sources.

TUNER button: Press to select the tuner.

SET UP button: Press to enter the set up mode.

ENTER button: Press to enter the completed name of the preset station or program source.

Naming Preset Stations and Program Sources

You can enter a name (index name) of up to 8 characters for preset stations and program sources. These names (for example, "VHS") appear in the receiver's display when a station or program source is selected.

Note that no more than one name can be entered for each preset station or program source.

This function is useful for distinguishing components of the same kind. For example, two VCRs can be specified as "VHS" and "8MM", respectively. It is also handy for identifying components connected to jacks meant for another type of component, for example, a second CD player connected to the MD/TAPE jacks.

1 To name a preset station

Press TUNER.

The last station you received is tuned in.

To name a program source

Select the program source (component) to be named, then go to Step 3.

2 Tune in the preset station you want to create an index name for.

If you are not familiar with how to tune in preset stations, see "Tuning to preset stations" on page 41.

3 Press NAME.

4 Create an index name by using the jog dial and cursor buttons:

Turn the jog dial to select a character, then press > to move the cursor to the next position.

To insert a space

Turn the jog dial until a blank space appears in the display (you can find the space character between "J" and "A").

If you've made a mistake

Press < or > repeatedly until the character to be changed flashes, then turn the jog dial to select the right character.

5 Press ENTER.

To assign index names to other stations

Repeat Steps 2 to 5.

Recording

Your receiver makes it easy to record to and from the components connected to it. You don't have to connect the playback and recording components directly to each other: once you select a program source on the receiver, you can record and edit as you normally would using the controls on each component.

Before you begin, make sure you've connected all components properly.

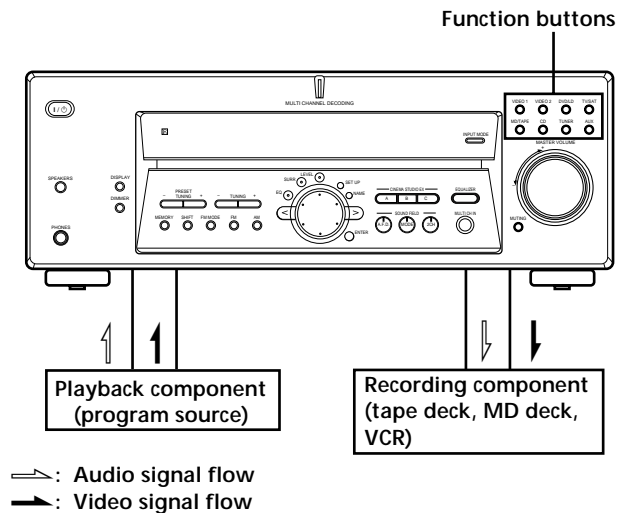

Recording on an audio tape or MiniDisc

You can record on a cassette tape or MiniDisc using the receiver. Refer to the instruction manual of your cassette deck or MD deck if you need help.

- 1 Select the component to be recorded.
- 2 Prepare the component for playing.
For example, insert a CD into the CD player.
- 3 Insert a blank tape or MD into the recording deck and adjust the recording level, if necessary.
- 4 Start recording on the recording deck, then start playback on the playback component.

Recording

Recording on a video tape

You can record from a TV, or an LD player using the receiver. You can also add audio from a variety of audio sources when editing a video tape. See your LD player's instruction manual if you need help.

- 1 Select the program source to be recorded.
- 2 Prepare the component for playing.
For example, insert the laser disc you want to record into the LD player.
- 3 Insert a blank video tape into the VCR for recording.
- 4 Start recording on the recording VCR, then start playing the laser disc you want to record.

 You can record the sound from any audio source onto a video tape while recording from a laser disc. Locate the point where you want to start recording from another audio source, select the program source, then start playback. The audio from that source will be recorded onto the audio track of the video tape instead of the audio from the original medium.

To resume audio recording from the original medium, select the video source again.

Notes

- You cannot record a digital audio signal using a component connected to the analog MD/TAPE OUT or VIDEO OUT jacks.
- Sound adjustments do not affect the signal output from the MD/TAPE OUT or VIDEO OUT jacks.
- When MULTI CH IN is selected, audio signals are not output from MD/TAPE OUT or VIDEO OUT jacks.

Using the Sleep Timer

You can set the receiver to turn off automatically at a specified time.

Press **SLEEP** on the remote while the power is on. Each time you press **SLEEP**, the time changes as shown below.

→ 2-00-00 → 1-30-00 → 1-00-00 → 0-30-00 → OFF

The display dims after you have specified the time.

 You can freely specify the time. First, press **SLEEP** on the remote, then specify the time you want using the jog dial on the receiver. The sleep time changes in 1 minute intervals. You can specify up to 5 hours.

 You can check the time remaining before the receiver turns off. Press **SLEEP** on the remote. The remaining time appears in the display.

Adjustment Using the SET UP Button

The SET UP button allows you to make the following adjustments.

Selecting the MULTI CH IN video input

This parameter lets you specify the video input to be used with the audio signals from the MULTI CH IN jack. The MULTI CH IN video input is set to DVD/LD by default.

- 1 Press SET UP.
- 2 Press the cursor buttons (< or >) to select "MULTI CH IN" VISUAL.
- 3 Turn the jog dial to select the video input you want.

Set the display to turn off

This parameter lets you specify whether or not the display turns off when you press the DIMMER button several times. When "WIDE" is selected, you can set the display to turn off, but when "NARROW" is selected, you cannot set the display to turn off. The default setting is set to "NARROW".

- 1 Press SET UP.
- 2 Press the cursor buttons (< or >) to select "DIM. RANGE".
- 3 Turn the jog dial to select "NARROW" or "WIDE".

CONTROL A1 II Control System

Getting Started

This section explains the basic functions of the CONTROL A1 II Control System. Certain components have special functions, like "CD Synchro Dubbing" on cassette decks, that require CONTROL A1 II connections. For detailed information regarding specific operations, be sure to also refer to the Operating Instructions supplied with your component(s).

The CONTROL A1 II Control System was designed to simplify the operation of audio systems composed of separate Sony components. CONTROL A1 II connections provide a path for the transmission of control signals which enable automatic operation and control features usually associated with integrated systems. Currently, CONTROL A1 II connections between a Sony CD player, amplifier (receiver), MD deck and cassette deck provide automatic function selection and synchronized recording.

In the future the CONTROL A1 II connection will work as a multifunction bus allowing you to control various functions for each component.

Notes

- The CONTROL A1 II Control System is designed to maintain upward compatibility as the Control System is upgraded to handle new functions. In this case, however, older components will not be compatible with the new functions.
- Do not operate a 2 way remote control unit when the CONTROL A1 II jacks are connected via a PC interface kit to a personal computer running "MD Editor" or similar application. Also, do not operate the connected component in a manner contrary to the functions of the application, as this may cause the application to operate incorrectly.

CONTROL A1 II and CONTROL A1 compatibility

The CONTROL A1 control system has been updated to the CONTROL A1 II which is the standard system in the SONY 300 disc CD changer and other recent Sony components. Components with CONTROL A1 jacks are compatible with components with CONTROL A1 II, and can be connected to each other. Basically, the majority of the functions available with the CONTROL A1 control system will be available with the CONTROL A1 II control system.

However, when making connections between components with CONTROL A1 jacks and components with CONTROL A1 II jacks, the number of functions that can be controlled may be limited depending on the component. For detailed information, refer to the Operating Instructions supplied with the component(s).

Connections

Connect monaural (2P) mini-plug cords in series to the CONTROL A1II jacks on the back of each component. You can connect up to ten CONTROL A1II compatible components in any order. However, you can connect only one of each type of component (i.e., 1 CD player, 1 MD deck, 1 tape deck and 1 receiver). (You may be able to connect more than one CD player or MD deck, depending on the model. Refer to the operating instructions supplied with the respective component for details.)

Example

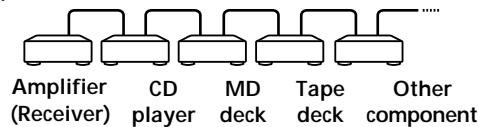

In the CONTROL A1II control system, the control signals flow both ways, so there is no distinction of IN and OUT jacks. If a component has more than one CONTROL A1II jack, you can use either one, or connect different components to each jack.

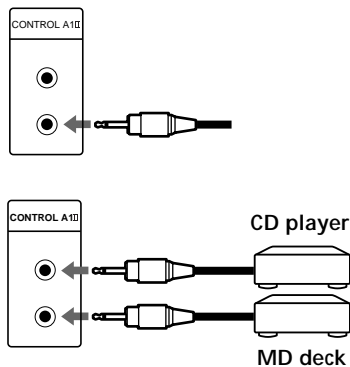

On CONTROL A1 jacks and connections

It is possible to make connections between CONTROL A1 and CONTROL A1II jacks. For details regarding particular connections or setup options, refer to the Operating Instructions supplied with the component(s).

About the connecting cord

Some CONTROL A1 compatible components are supplied with a connecting cord as an accessory. In this case, use the connecting cord for your connection. When using a commercially available cord, use a monaural (2P) mini-plug cord less than 2 meters long, with no resistance (like the Sony RK-G69HG).

Basic Functions

The CONTROL A1II functions will operate as long as the component you want to operate is turned on, even if all of the other connected components are not turned on.

Automatic function selection

When you connect a CONTROL A1II compatible Sony amplifier (or receiver) to other Sony components using monaural mini-plug cords, the function selector on the amplifier (or receiver) automatically switches to the correct input when you press the play button on one of the connected components.

Notes

- You must connect a CONTROL A1 compatible amplifier (receiver) using a monaural mini-plug cord in order to take advantage of the automatic function selection feature.
- This function only works when the components are connected to the amplifier (or receiver) inputs according to the names on the function buttons. Certain receivers allow you to switch the names of the function buttons. In this case, refer to the Operating Instructions supplied with the receiver.
- When recording, do not play any components other than the recording source. It will cause the automatic function selection to operate.

Synchronized recording

This function lets you conduct synchronized recording between the selected source and recorder components.

- 1 Set the function selector on the amplifier (or receiver) to the source component.
- 2 Set the source component to pause mode (make sure both the ► and || indicators light together).
- 3 Set the recorder component to the REC-PAUSE mode.
- 4 Press PAUSE on the recorder component. The source component is released from the pause mode, and recording begins shortly thereafter. When playback ends from the source component, recording stops.

Notes

- Do not set more than one component to the pause mode.
- Certain recorder components may be equipped with a special synchronized recording function that uses the CONTROL A1II Control System, like "CD Synchro Dubbing". In this case, refer to the Operating Instructions supplied with the recorder component.

Additional Information

Troubleshooting

If you experience any of the following difficulties while using the receiver, use this troubleshooting guide to help you remedy the problem. Also, see “Checking the connections” on page 21 to verify that the connections are correct. Should any problem persist, consult your nearest Sony dealer.

There’s no sound or only a very low-level sound is heard.

- ➔ Check that the speakers and components are connected securely.
- ➔ Make sure that you’ve selected the correct component on the receiver.
- ➔ Check that the SPEAKERS button is not set to OFF.
- ➔ Press MUTING if MUTING appears on the display.
- ➔ The protective device on the receiver has been activated because of a short circuit. Turn off the receiver, eliminate the short-circuit problem and turn on the power again.

The left and right sounds are unbalanced or reversed.

- ➔ Check that the speakers and components are connected correctly and securely.
- ➔ Adjust front balance parameter in the LEVEL menu.

Severe hum or noise is heard.

- ➔ Check that the speakers and components are connected securely.
- ➔ Check that the connecting cords are away from a transformer or motor, and at least 3 meters (10 feet) away from a TV set or fluorescent light.
- ➔ Move your TV away from the audio components.
- ➔ The plugs and jacks are dirty. Wipe them with a cloth slightly moistened with alcohol.

No sound is heard from the center speaker.

- ➔ Make sure the sound field function is on (press SOUND FIELD MODE).
- ➔ Select the appropriate center mode (see pages 28 – 31).
- ➔ Adjust the speaker volume (see page 20).
- ➔ Make sure the center speaker size parameter is set to either SMALL or LARGE (see page 18).

Troubleshooting

No sound or only a very low-level sound is heard from the surround speakers.

- ➔ Make sure the sound field function is on (press SOUND FIELD MODE).
- ➔ Select the appropriate center mode (see pages 28 – 31).
- ➔ Adjust the speaker volume (see page 20).
- ➔ Make sure the surround speaker size parameter is set to either SMALL or LARGE (see page 18).

No sound is heard from the sub woofer.

- ➔ Make sure the sub woofer is set to YES (see page 19).
- ➔ Check that 2CH mode has not been selected (see page 31).

Recording cannot be done.

- ➔ Check that the components are connected correctly.
- ➔ Select the source component with a FUNCTION button.
- ➔ When recording from a digital component, make sure the input mode is set to ANALOG (see page 25) before recording with a component connected to the analog MD/TAPE terminals.

Radio stations cannot be tuned in.

- ➔ Check that the antennas are connected securely. Adjust the antennas and connect an external antenna if necessary.
- ➔ The signal strength of the stations is too weak (when tuning in with automatic tuning). Use direct tuning.
- ➔ Make sure you set the tuning interval correctly (when tuning in AM stations with direct tuning) (see pages 40 and 50).
- ➔ No stations have been preset or the preset stations have been cleared (when tuning by scanning preset stations). Preset the stations (see page 41).
- ➔ Press DISPLAY so that the frequency appears in the display.

The surround effect cannot be obtained.

- ➔ Make sure the sound field function is on (press SOUND FIELD MODE).

“PCM--kHz” appears on the display.

- ➔ The sampling frequency is more than 48 kHz. Change the input player setting to 48 kHz.

Nothing appears on the display.

- ➔ When the display turns off immediately after the receiver is turned on, press DIMMER to change the display mode.

No picture or an unclear picture appears on the TV screen or monitor.

- ➔ Select the appropriate function on the receiver.
- ➔ Set your TV to the appropriate input mode.
- ➔ Move your TV away from the audio components.

The remote does not function.

- ➔ Point the remote at the remote sensor  on the receiver.
- ➔ Remove any obstacles in the path between the remote and the receiver.
- ➔ Replace both batteries in the remote with new ones, if they are weak.
- ➔ Make sure you select the correct function on the remote.
- ➔ If the remote is set to operate the TV only, use the remote to select a source or component other than TV before operating the receiver or other component.

Reference sections for clearing the receiver's memory

To clear	See
All memorized settings	page 16
Customized sound fields	page 36

Specifications

Amplifier section

POWER OUTPUT

Models of area code SP, AU, E2/E3

Rated Power Output at Stereo mode
(8 ohms at 1 kHz, THD
0.7%)
100 W + 100 W

Reference Power Output

(8 ohms at 1 kHz, THD
10%)
Front: 110 W/ch
Center: 110 W
Surround: 110 W/ch

Models of area code CN

Rated Power output at stereo mode
(8 ohms at 1 kHz, THD
0.7%)
90 W + 90 W
(at 220 V AC, 50 Hz)
100 W + 100 W
(at 230 V AC, 50 Hz)

Reference Power output

(8 ohms at 1 kHz, THD
10% at 230 V AC, 50
Hz)
Front: 110 W/ch
Center: 110 W
Surround: 110 W/ch

Models of area code TW

Rated Power output at stereo mode
(8 ohms at 1 kHz, THD
0.7%)
100 W + 100 W
(at 110 V AC, 50 Hz)

Reference Power Output

(8 ohm at 1 kHz, THD
10% at 110V AC, 50
Hz)
Front: 110 W/ch
Center: 110 W
Surround: 110 W/ch

Frequency response

MULTI CH IN, CD, MD/
TAPE, DVD/LD, TV/
SAT, VIDEO 1,
VIDEO 2, AUX:
10 Hz - 50 kHz + 0.5/
-2 dB (with sound
field and equalizer,
bypassed)

Inputs (Analog)

MULTI CH IN, CD,
DVD/LD, MD/TAPE,
TV/SAT, VIDEO 1,
VIDEO 2, AUX:
Sensitivity: 250 mV
Impedance: 50
kilohms
S/N^{a)}: 96 dB (A, 250
mV^{b)})

a) *INPUT SHORT*

b) *Weighted network, input level*

Inputs (Digital)

DVD/LD (coaxial):
Sensitivity: -
Impedance: 75 ohms
S/N: 100 dB (A, 20
kHz LPF)
DVD/LD, TV/SAT,
MD/TAPE (optical):
Sensitivity: -
Impedance: -
S/N: 100 dB (A, 20
kHz LPF)

Outputs

MD/TAPE (REC OUT);
VIDEO 1, VIDEO 2,
(AUDIO OUT):
Voltage: 250 mV,
Impedance: 10
kilohms
SUB WOOFER:
Voltage: 2 V
Impedance: 1
kilohms
PHONES:
Accepts low- and
high-impedance
headphones

EQ ±6 dB

Sampling Frequency

48 kHz (TV/SAT, MD/
TAPE, OPTICAL IN)
96 kHz (DVD/LD
OPTICAL IN,
COAXIAL IN)

FM tuner section

Tuning range 87.5 - 108.0 MHz

Antenna terminals

75 ohms, unbalanced

Intermediate frequency

10.7 MHz

Sensitivity

Mono: 18.3 dBf, 2.2
μV/75 ohms
Stereo: 38.3 dBf, 22.5
μV/75 ohms

Usable sensitivity

11.2 dBf, 1 μV/75
ohms

S/N

Mono: 76 dB
Stereo: 70 dB

Harmonic distortion at 1 kHz

Mono: 0.3%
Stereo: 0.5%

Separation

45 dB at 1 kHz

Frequency response

30 Hz - 15 kHz +0.5/
-2 dB

Selectivity

60 dB at 400 kHz

Specifications

AM tuner section

Tuning range Models of area code AU, SP, CN
531 - 1602 kHz (9 kHz step)

Models of area code E2, E3, TW
530 - 1610 kHz (10 kHz step)^{c)}
531 - 1602 kHz (9 kHz step)^{c)}

Antenna Loop antenna

Intermediate frequency
450 kHz

Usable sensitivity
50 dB/m (at 999 kHz)

S/N 54 dB (at 50 mV/m)

Harmonic distortion
0.5 % (50 mV/m, 400 Hz)

Selectivity At 9 kHz: 35 dB
At 10 kHz: 40 dB

c) You can change the AM tuning interval to 10 kHz. After tuning in any AM station, turn off the receiver. Hold down the TUNING + button and press the I/⏻ button. All preset stations will be erased when you change the tuning interval. To reset the scale to 10 kHz, repeat the procedure.

Video section

Inputs Video: 1 Vp-p 75 ohms
S-video:
Y: 1 Vp-p 75 ohms
C: 0.286 Vp-p 75 ohms

Outputs Video: 1 Vp-p 75 ohms
S-video:
Y: 1 Vp-p 75 ohms
C: 0.286 Vp-p 75 ohms

General

System Tuner section:
PLL quartz-locked digital synthesizer system

Preamplifier section:
Low-noise NF type equalizer

Power amplifier section:
Pure-complementary SEPP

Power requirements

Models of area code AU: 240 V AC, 50 Hz

Models of area code SP, CN:
220 - 230 V AC, 50/60 Hz

Models of area code E2, E3:
120/220/240 V AC, 50/60 Hz

Models of area code TW:
110V AC, 50/60 Hz

Power consumption

Models code area code AU, E2, E3:
210 W
In standby condition:
1 W

Models code area code SP, CN:
210 W
In standby condition:
1 W

Models code area code TW:
410 W
In standby condition:
1 W

AC outlets 1 switched, total 100 W maximum (except models of area code CN)

Dimensions 430 × 308.5 × 157.5 mm including projecting parts and controls

Mass (Approx.)
7.5 kg

Supplied accessories
See page 4.

For details on the area code of the component you are using, see page 3.

The specification measured is under

- 230 V AC 50 Hz condition (models of area code SP, CN).
- 240 V AC 50 Hz condition (models of area code AU, E2, E3).
- 110 V AC 50 Hz condition (models of area code TW).

Design and specifications are subject to change without notice.

Glossary

Surround sound

Sound that consists of three elements: direct sound, early reflected sound (early reflections) and reverberative sound (reverberation). The acoustics of the surrounding space affect the way these three sound elements are heard. Surround sound combines these sound elements in such a way that you actually can sense the size of the venue, as well as its type.

- Types of sound

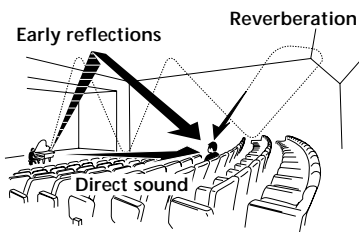

- Transition of sound from surround speakers

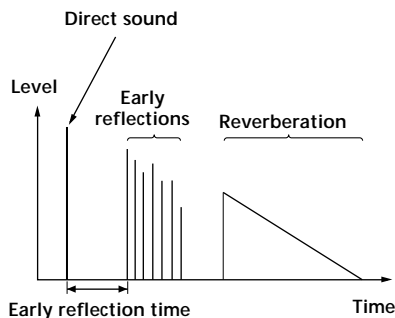

Dolby Pro Logic Surround

As one method of decoding Dolby Surround, Dolby Pro Logic Surround produces four channels from two-channel sound. Compared with the former Dolby Surround system, Dolby Pro Logic Surround reproduces left-to-right panning more naturally and localizes sounds more precisely. To take full advantage of Dolby Pro Logic Surround, you should have one pair of surround speakers and a center speaker. The surround speakers output monaural sound.

Dolby Digital

This sound format for movie theaters is more advanced than Dolby Pro Logic Surround. In this format, the surround speakers output stereo sound with an expanded frequency range and a sub woofer channel for deep bass is independently provided. This format is also called “5.1” because the sub woofer channel is counted as 0.1 channel (since it functions only when a deep bass effect is needed). All six channels in this format are recorded separately to realize superior channel separation. Furthermore, since all the signals are processed digitally, less signal degradation occurs.

Digital Cinema Sound

This is the generic name of the surround sound produced by digital signal processing technology developed by Sony. Unlike previous surround sound fields mainly directed at the reproduction of music, Digital Cinema Sound is designed specifically for the enjoyment of movies.

Settings Using SURR, LEVEL, EQ, and SET UP buttons

You can make various settings using the LEVEL, SURR, EQ, SET UP buttons, jog dial, and cursor buttons. The table below shows each of the settings that these buttons can make.

Press and light	Press < or > to select	Turn jog dial to select	See page
SURR button	EFFECT LEVEL	depends on sound mode (in 16 steps)	34
	WALL TYPE	between -8 to +8 (in 1 increment steps)	
	REVERBERATION TIME	between -8 to +8 (in 1 increment steps)	
	SCREEN DEPTH	SCR. OFF, SCR. MID or SCR. DEEP	
LEVEL button	FRONT BALANCE	between -8 to +8 (in 1 increment steps)	35
	SURR BALANCE	between -8 to +8 (in 1 increment steps)	
	CENTER LEVEL	between -6 dB to +6 dB (in 1 dB steps)	
	SURR LEVEL	between -6 dB to +6 dB (in 1 dB steps)	
	SUB WOOFER LEVEL	between -6 dB to +6 dB (in 1 dB steps)	
	LFE MIX LEVEL	OFF, or -20 dB to 0 dB (in 1 dB steps)	
	DYNAMIC RANGE COMP	OFF, 0.1 to 0.9 (in 0.1 dB steps), STD, or MAX	
EQ button	FRONT BASS GAIN	between -6 dB to +6 dB (in 1 dB steps)	36
	FRONT BASS FREQUENCY	between 99 Hz and 1.0 kHz (in 21 steps)	
	FRONT TREBLE GAIN	between -6 dB to +6 dB (in 1 dB steps)	
	FRONT TREBLE FREQUENCY	between 1.0 kHz and 10 kHz (in 23 steps)	
*SET UP	[L] [R] (FRONT)	LARGE or SMALL	17
	[C] (CENTER)	LARGE, SMALL, or NO	
	[SL] [SR] (SURR)	LARGE, SMALL, or NO	
	S. W. (SUB WOOFER)	S.W. YES or S.W. NO	
	[L] [R] (FRONT) XX.X m	between 3 feet (1.0 meters) and 40 feet (12.0 meters) (in 1 foot (0.1 meter) steps)	
	[C] (CENTER) XX.X m	between FRONT and 5 feet (1.5 meters) (in 1 foot (0.1 meter) steps)	
	[SL] [SR] (SURR) XX.X m	between FRONT and 15 feet (4.5 meters) (in 1 foot (0.1 meter) steps)	
	[SL] [SR] (SURR) PL. XX.X	PL. SIDE, PL. MID or PL. BEHD.	
	[SL] [SR] (SURR) HGT. XX.X	HGT. LOW or HGT. HIGH	
	[MULTI CH IN] VISUAL XX.X	V-VIDEO 1, V-VIDEO 2, V-DVD/LD, V-TV/SAT	
DIM.RANGE	NARROW or WIDE		

* When you press the SET UP button, you can select NORM. SP. (for normal speakers) or MICRO SP. (for Micro Satellite speakers). (page 17)

Remote Button Description

You can use the remote to operate the components in your system. The tables below show the settings of each button.

Remote Button	Operations	Function
SLEEP	Receiver	Activates the sleep function and the duration which the receiver turns off automatically.
AV I/⏻	TV/VCR/ CD player/ DVD player/ MD deck/ VCD player/ LD player/ DAT deck	Turns the audio and video components on or off.
I/⏻	Receiver	Turns the receiver on or off.
VIDEO/ VIDEO 1	Receiver	To watch VCR. (VTR mode 3)
VIDEO 2	Receiver	To watch VCR. (VTR mode 1)
VIDEO 3	Receiver	To watch VCR. (VTR mode 2)
DVD/LD	Receiver	To watch DVD or laser disc.
TV/SAT	Receiver	To watch TV programs or satellite receiver.
MD/TAPE	Receiver	To listen to Minidisc or audio tape.
CD/SACD	Receiver	To listen to compact disc.
TUNER	Receiver	To listen to radio programs.
PHONO	Receiver	To listen to turn table.
AUX	Receiver	To listen to an audio equipment.
FN SHIFT*	Remote	Use simultaneously to select other function.
0-9	Receiver	Use with "SHIFT" button to select tuner preset station numeric input during DIRECT TUNING or MEMORY mode.
	CD player/ MD deck/ VCD player/ LD player/ DAT deck	Selects track numbers. 0 selects track 10.
	TV/VCR/SAT	Selects channel numbers.
>10	CD player/ MD deck/ Tape deck/ LD player/ VCD player	Selects tracks numbers over 10.

Remote Button	Operations	Function
ENTER	TV/VCR/SAT/ Tape deck/ LD player/ VCD player/ MD deck/ DAT deck	After selecting a channel, disc or track using the numeric buttons, press to enter the value.
SHIFT	Receiver	Press repeatedly to select a memory page for presetting radio stations or tuning to preset stations.
-/--	TV	Selects the channel entry mode, either one or two digit.
D.TUNING	Receiver	Tuner station direct key-in mode.
◀◀/▶▶	CD player/ MD deck/ DVD player/ LD player/ VCD player/ Tape deck/VCR/ DAT deck	Skips tracks.
◀▶	CD player/ DVD player/ VCD player	Searches tracks (forward or backward).
	MD deck/ Tape deck/ VCR/ LD player/ DAT deck	Fastforwards or rewinds.
◀	Tape deck	Starts play on the reverse side.
▶	CD player/ MD deck/Tape deck/VCR/ DVD player/ VCD player/ LD player/ DAT deck	Starts play.

* VIDEO 1, VIDEO 2, VIDEO 3, PHONO and MD/TAPE function is a 2-key operation. To select the above function, press FN SHIFT (function shift) and the function key you want simultaneously.
For example, press FN SHIFT and CD/SACD to select MD/TAPE function.

Note

When you press the function buttons (VIDEO, DVD/LD, TV/SAT), the input mode of the TV might not switch to the corresponding input mode that you want. In this case, press the TV/VIDEO button to switch the input mode of the TV.

Remote Button Description

Remote Button	Operations	Function
■	CD player/ MD deck/Tape deck/VCR/ DVD player/ VCD player/ LD player/ DAT deck	Pauses play or record. (Also starts recording with components in record standby.)
■	CD player/ MD deck/Tape deck/VCR/ DVD player/ VCD player/ LD player/ DAT deck	Stops play.
POSITION**	TV	Changes the position of the small picture.
SWAP**	TV	Swaps the small and the large picture.
DISC	CD player	Select discs (Mega storage CD player only).
SUB CH +/-**	TV	Selects preset channels for the small picture.
D. SKIP/CH/ PRESET +/-	Receiver	Scans and selects preset stations.
	TV/VCR/SAT	Selects preset channels.
	CD player	Skips discs (CD player with multi-disc changer only).
DISPLAY	TV/VCR/ LD player/ DVD player/ VCD player	Selects information displayed on the TV screen.
P IN P**	TV	Activates the picture-in- picture function.
JUMP	TV	Toggles between the previous and the current channels.
WIDE	TV	Selects the wide picture mode.
ANT TV/VTR	VCR	Selects output signal from the aerial terminal: TV signal or VCR program.
TV/VIDEO	TV/VCR	Selects input signal: TV input or video input.
A. F. D.	Receiver	Auto Format Decoding.
2CH/OFF	Receiver	Turns off sound field or selects 2CH mode.
MODE +/-	Receiver	Selects sound field mode.
MULTI CH/ 2 CH DIRECT	Receiver	Selects MULTI CH IN source.
MUTING	Receiver	Mutes the sound from the receiver.

Remote Button	Operations	Function
TEST TONE	Receiver	Press to output test tone.
MAIN MENU	Receiver	Press this button repeatedly to select one of the two cursor modes: LEVEL and SURROUND.
MASTER VOL +/-	Receiver	Adjusts the master volume of the receiver.
MENU </>	Receiver	Selects a menu item.
MENU +/-	Receiver	Makes adjustment or change the setting.
MENU	DVD player	Displays DVD menu.
⇄/⇄/⇄/⇄	DVD player	Selects a menu item.
ENTER	DVD player	Enters the selection.
RETURN	DVD player	Returns to the previous menu or exits the menu.
TITLE	DVD player	Displays DVD title.

** Only for Sony TVs with the picture-in-picture function.

Notes

- Some functions explained in this section may not work depending on the model of the receiver.
- The above explanation is intended to serve as an example only. Therefore, depending on the component the above operation may not be possible or may operate differently than described.
- The VIDEO 1, VIDEO 2, VIDEO 3 and PHONO functions are not available for set operation.

Changing the factory setting of a function button

If the factory settings of the FUNCTION buttons don't match your system components, you can change them. For example, if you have an MD player and a tape deck and you don't have a CD player, you can assign the CD/SACD button to your tape deck.

Note that the settings of the TUNER and FN SHIFT functions (VIDEO 1, VIDEO 2, VIDEO 3, PHONO and MD/TAPE) button cannot be changed.

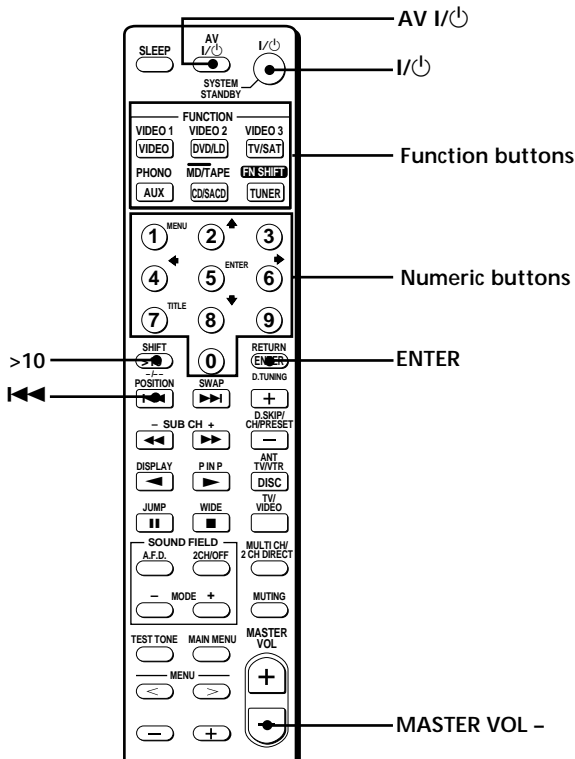

- 1 Hold down the Function button whose function you want to change (for example, CD/SACD).
- 2 Press the corresponding button of the component you want to assign to the Function button (for example, 4 - Tape deck).

The following buttons are assigned to select the functions:

To operate	Press
CD player	1
DAT deck	2
MD deck	3
Tape deck A	4
Tape deck B	5
LD player	6
VCR (remote control mode VTR 1*)	7
VCR (remote control mode VTR 2*)	8
VCR (remote control mode VTR 3*)	9
TV	0
DSS (Digital Satellite Receiver)	>10
DVD	ENTER
VCD player	⏮

* Sony VCRs are operated with a VTR 1, 2 or 3 setting. These correspond to Beta, 8mm and VHS respectively.

Now you can use the CD/SACD button to control the tape deck.

To reset a button to its factory setting
Repeat the above procedure.

To reset all the function buttons to their factory setting
Press I/⏻, AV I/⏻ and MASTER VOL - at the same time.

Index

A

- AC-3. *See Dolby Digital (AC-3)*
- Adjusting
 - brightness of the display 23
 - speaker volumes 20
 - surround parameters 34
- Automatic tuning 40

B

- Basic receiver operations 23 - 26
- Batteries 4

C

- Changing
 - display 23
 - effect level 34
- Checking the connections 21
- Clearing receiver's memory 16
- Connecting. *See Hookups*
- CONTROL A1 II 11, 45
- Customizing sound fields 36

D

- Demonstration mode 16
- Digital Cinema Sound 51
- Direct tuning 40
- Dolby Digital (AC-3) 51
- Dolby Pro Logic Surround 51
- Dubbing. *See Recording*

E, F, G

- Editing. *See Recording*
- Effect level 34

H

- Hookups
 - MULTI CH INPUT 10
 - AC power cord 11
 - antennas 5
 - audio components 6
 - digital components 8
 - CONTROL A1 II 11, 45
 - speaker system 14
 - video components 7

I, J, K

- Indexing. *See Naming*

L, M

- Labeling. *See Naming*

N, O

- Naming
 - preset stations 43
 - program sources 43

P, Q

- Parameter 34, 37
- Preset stations
 - how to preset 41
 - how to tune 41
- Preset tuning 41

R

- Receiving broadcasts
 - automatically 40
 - directly 40
 - preset stations 41
- Recording
 - on an audio tape or MD 43
 - on a video tape 44

S

- Scanning
 - preset stations. *See Preset tuning*
 - radio stations. *See Automatic tuning*
- Selecting
 - component 25
 - sound field 28
- Sleep timer 44
- Sound field
 - adjustable parameters 37
 - customizing 34
 - pre-programmed 28 - 31
 - resetting 36
 - selecting 28

Speakers

- adjusting speaker volume 20
- connection 14
- placement 17
- Supplied accessories 4
- Surround sound 27 - 37

T

- Test tone 20
- Troubleshooting 47
- Tuning
 - automatically 40
 - directly 40
 - preset stations 41

U, V, W, X, Y, Z

- Unpacking 4