

Super Audio CD Player

Operating Instructions



SCD-XB780

WARNING

To prevent fire or shock hazard, do not expose the unit to rain or moisture.

To avoid electrical shock, do not open the cabinet. Refer servicing to qualified personnel only.

To prevent fire, do not cover the ventilation of the apparatus with news papers, tablecloths, curtains, etc. And don't place lighted candles on the apparatus.

To prevent fire or shock hazard, do not place objects filled with liquid, such as vases, on the apparatus.

This appliance is classified as a CLASS 1 LASER product.

This label is located on the rear exterior.

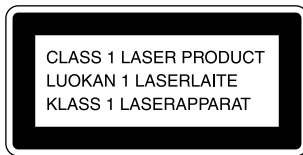

The following caution label is located inside the unit.



Don't throw away the battery with general house waste, dispose of it correctly as chemical wastes.

Welcome!

Thank you for purchasing the Sony Super Audio CD Player. Before operating the unit, please read this manual thoroughly and retain it for future reference.

About This Manual

The instructions in this manual are for model SCD-XB780.

Conventions

- Instructions in this manual describe the controls on the player. You can also use the controls on the remote if they have the same or similar names as those on the player.
- The following icons are used in this manual:



Indicates that you can do the task using the remote.



Indicates hints and tips for making the task easier.

Features

About the Super Audio CD

- Super Audio CD is a new high-quality audio disc standard where music is recorded in the DSD (Direct Stream Digital) format (conventional CDs are recorded in the PCM format). The DSD format, using a sampling frequency 64 times higher than that of a conventional CD, and with 1-bit quantization, achieves both a wide frequency range and a wide dynamic range across the audible frequency range, and so provides music reproduction extremely faithful to the original sound.
- The Super Audio CD has two types; a 2 channel stereo disc and a Multi-channel disc which holds up to 6 independent channels. The multi-channel characteristic of the Super Audio CD features a speaker allocation system basically similar to the 5.1 channel output of current AV systems.

Features of the player

This player is designed to play back 2-channel and multi-channel Super Audio CDs, and conventional CDs, and provides the following features:

- Mounted with a Discrete Dual Laser Optical Pickup, capable of reading a Super Audio CD or conventional CD depending on the exclusive wavelength.
- Quicker track access performance enabled by an advanced servo mechanism.
- A Multi-Channel Management function that allows you to adjust the multi-channel playback environment according to the allocation and size of your speakers.
- A Super Audio D/A Converter and Direct Digital Sync System, which allows higher-quality sound reproduction.

Others

- A Super Audio CD can mark up to 255 track/index numbers. This feature applies to SCD-XB780.
- The supplied remote is capable of controlling both the SCD-XB780 and a conventional Sony CD player.

TABLE OF CONTENTS

Getting Started 4

- Before You Start the Hookup 4
- Hooking Up the Audio Components 5

Location and Functions of Parts 8

- Front Panel Parts Descriptions 8
- Rear Panel Parts Descriptions 10
- Remote Parts Descriptions 11

Playing Discs 12

- Compatible Disc Types 12
- Playing a Disc 14
- Using the Display 15
- Locating a Specific Track 18
- Locating a Particular Point in a Track 18
- Playing Tracks Repeatedly 19
- Playing Tracks in Random Order (Shuffle Play) 20
- Creating Your Own Programme (Programme Play) 21
- Listening to a Multi-channel Super Audio CD (Multi-channel management function) 22

Additional Information 25

- Precautions 25
- Notes on Discs 26
- Troubleshooting 27
- Specifications 27
- Index Back cover

Getting Started

This chapter provides information on the supplied accessories and how to connect various audio components to the Super Audio CD player. Be sure to read this chapter thoroughly before you actually connect anything to the player.

Before You Start the Hookup

Checking the supplied accessories

This player comes with the following items:

- Audio connecting cord
Stereo cable (1)
- Remote commander RM-SX700 (1)
- R06 (size-AA) batteries (2)

Inserting batteries into the remote

Insert two R06 (size-AA) batteries into the battery compartment with the + and – correctly oriented to the markings. When using the remote, point it at the remote sensor  on the player.

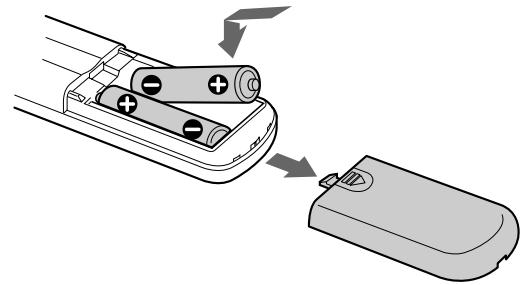

When to replace the batteries

Under normal conditions, the batteries should last for about six months. When the remote no longer operates the player, replace both batteries with new ones.

Notes

- Do not leave the remote in an extremely hot or a humid place.
- Do not drop any foreign object into the remote casing, particularly when replacing the batteries.
- Do not use a new battery with an old one.
- Do not expose the remote sensor to direct sunlight or lighting apparatus. Doing so may cause a malfunction.
- If you do not intend to use the remote for an extended period of time, remove the batteries to avoid possible damage from battery leakage and corrosion.

Hooking Up the Audio Components

Connect the Super Audio CD player to an audio component. Be sure to turn off the power of all components before making connections and connect securely to prevent noise.

When you have an amplifier equipped with the 5.1CH input jacks (multi-channel amplifier, AV amplifier, etc.) and connect the player and the amplifier via ANALOG 5.1CH OUT jacks, you can play a multi-channel Super Audio CD and enjoy the multi-channel playback. For normal playback, connect the player and an amplifier via ANALOG 2CH OUT jacks.

Connecting via ANALOG 2CH OUT jacks

Use an audio connecting cords for this connection. Connect the ANALOG 2CH OUT L/R jacks to the CD (Super Audio CD) input jacks of your amplifier. Be sure to match the colour-coded pin to the appropriate jacks: white (left) to white and red (right) to red.

Audio connecting cords (Red and White) (supplied)

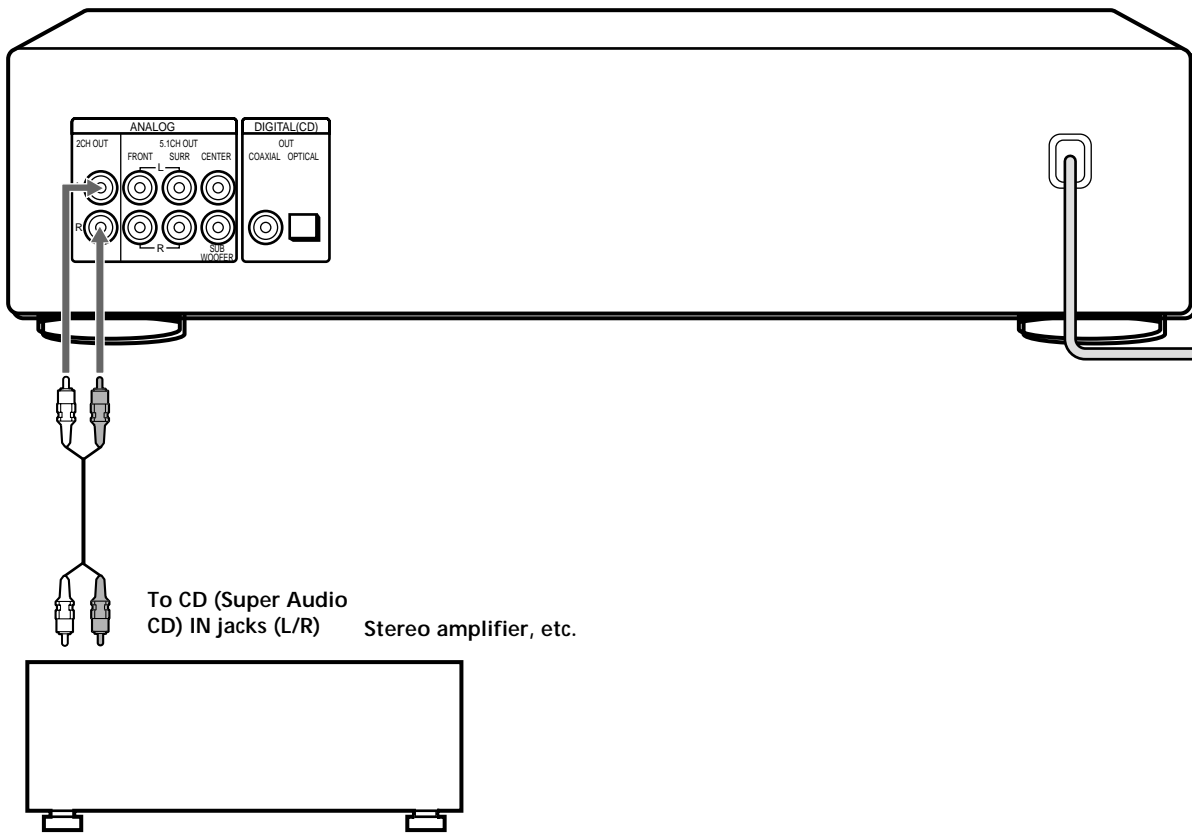
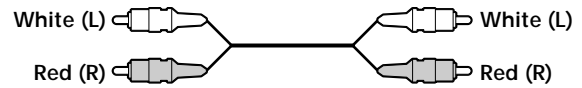

Hooking Up the Audio Components

Connecting via ANALOG 5.1CH OUT jacks

Use audio connecting cords for this connection. Connect the ANALOG 5.1CH OUT jacks (FRONT L/R, SURR L/R, CENTER, SUBWOOFER) to the corresponding jacks of your amplifier. For FRONT or SURR connection, use the connecting cords (Red and White jacks) (one audio cord is supplied with the player) and be sure to match the colour-coded pin to the appropriate jacks: white (left) to white and red (right) to red. For CENTER and SUB WOOFER connection, use the connecting cords (Black) (not supplied).

FRONT or SURR connection

Audio connecting cords (Red and White) (one audio cord is supplied with the player)

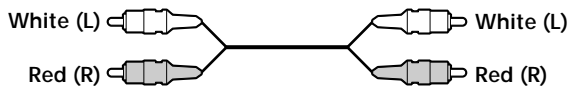

CENTER or SUB WOOFER connection

Audio connecting cords (Black) (not supplied)



Notes

- When you make the Multi-channel connection, connect the ANALOG 2CH OUT jacks also using another audio connecting cord so that you can play a CD (or Super Audio CD) when you set the input selector of your amplifier to CD (or Super Audio CD) input .
- During playback of a conventional CD or a 2CH Super Audio CD, the same signal that is output from the ANALOG 2CH OUT jacks is also output from the ANALOG 5.1CH FRONT L/R jacks.
- During playback of a Multi-channel Super Audio CD, the same signal that is output from the ANALOG 5.1CH FRONT L/R jacks is also output from the ANALOG 2CH OUT jacks. (The down mixed signal of the Multi-channel signal is not played back.)
- There are 5CH, 4CH, and 3CH Super Audio CD. When you play these disc, the signal does not output from all the jacks of the ANALOG 5.1CH OUT. For details of the playback, see the cover or instructions of the Super Audio CD.

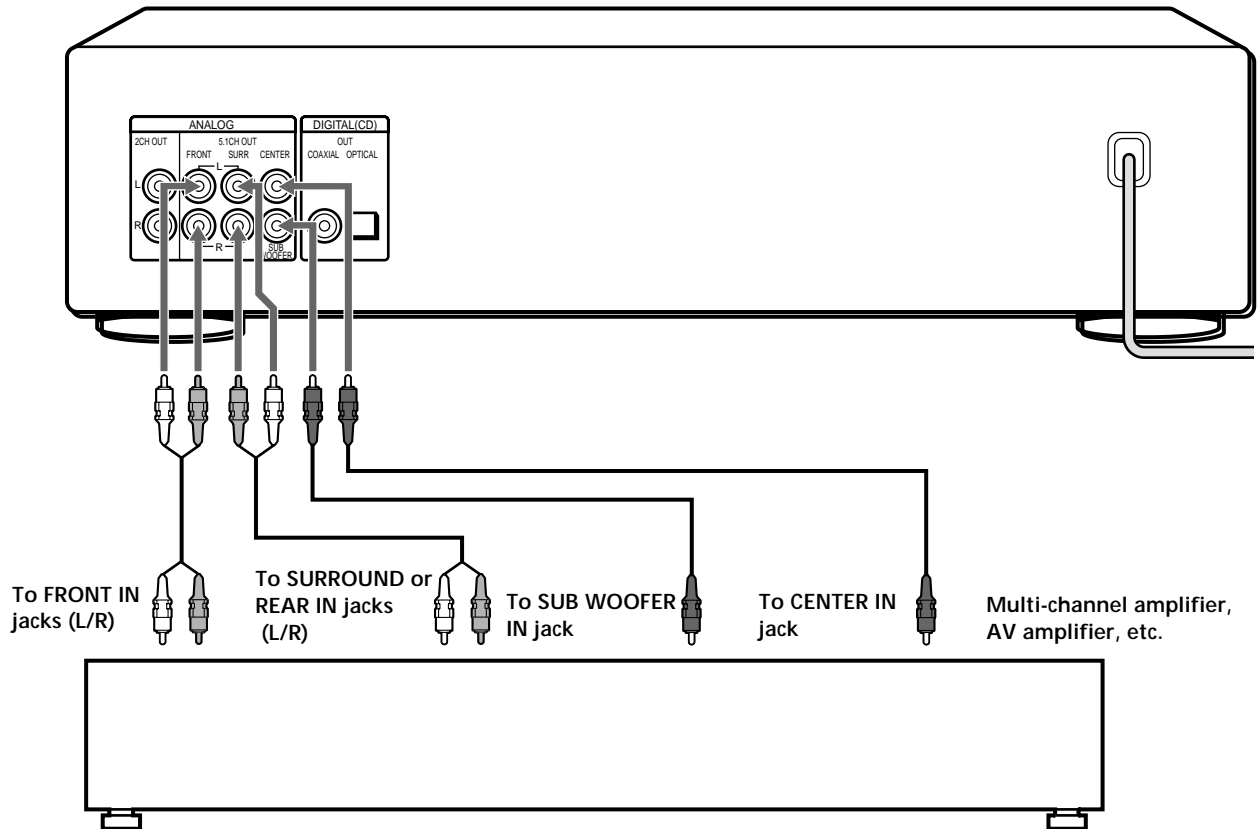

Connecting via DIGITAL (CD) OUT OPTICAL connector

Use an optical digital cable for this connection. When connecting the optical digital cable to the DIGITAL (CD) OUT OPTICAL connector, take the cap off the connectors and push the cable plugs in until they click into place.

Be careful not to bend or twist the optical cable.

Optical digital cable (not supplied)

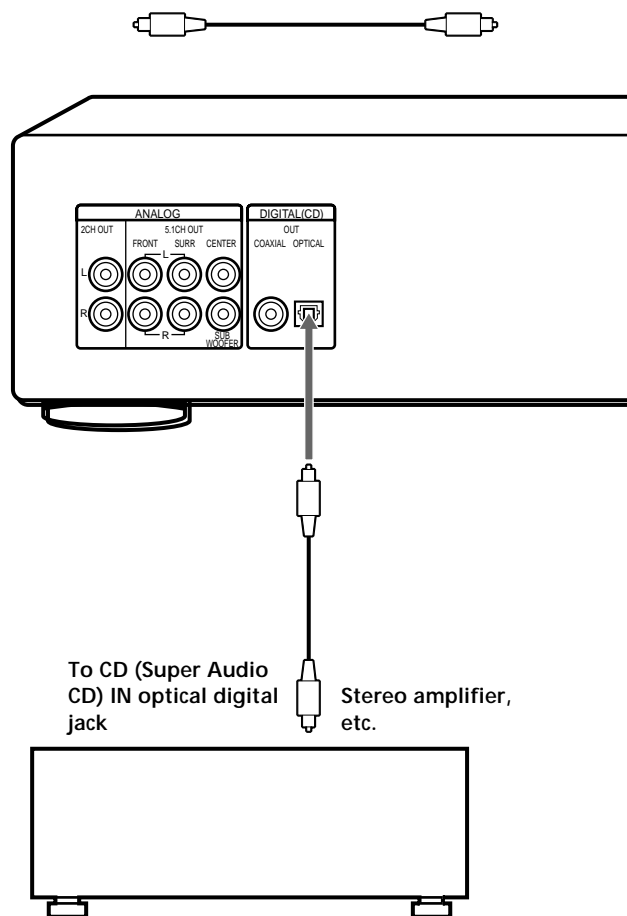

Note

Only the audio signals of conventional CDs can be output from the DIGITAL (CD) OUT connectors. Those of the Super Audio CD cannot be output through DIGITAL (CD) OUT.

Connecting via DIGITAL (CD) OUT COAXIAL connector

Use a coaxial digital cable to connect the audio components equipped with coaxial digital input connectors.

Coaxial digital cable (not supplied)

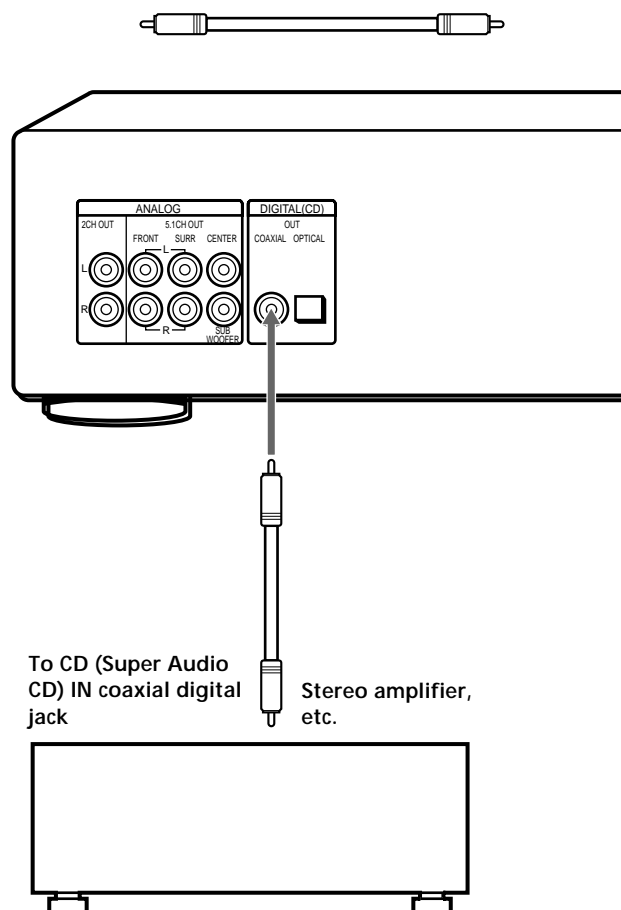

Note

Only the audio signals of conventional CDs can be output from the DIGITAL (CD) OUT connectors. Those of the Super Audio CD cannot be output through DIGITAL (CD) OUT.

Connecting the AC power cord

Connect the AC power cord to a wall outlet.

Location and Functions of Parts

This chapter tells you about the location and functions of the various buttons and controls on the front and rear panels and the supplied remote. Further details are provided on the pages indicated in parentheses. It also tells you about the information that appears in the display window.

Front Panel Parts Descriptions

- 1 POWER switch (14)**
Press to turn on the player.
- 2 TIME/TEXT button (15)**
Each time you press the button, the playing time of the track, the total remaining time on the disc, or TEXT information appears in the display.
- 3 SACD/CD button (13)**
Each time you press the button while playing back a hybrid disc, the layer to be played back switches between the HD (Super Audio CD) layer and the CD layer.
- 4 Disc tray (14)**
Press \cong OPEN/CLOSE to open/close the disc tray.
- 5 Multi-channel indicator**
Turns on when you turn on the player, or when the Multi-channel Super Audio CD is loaded and select the Multi-channel playback area by pressing MULTI/2CH.

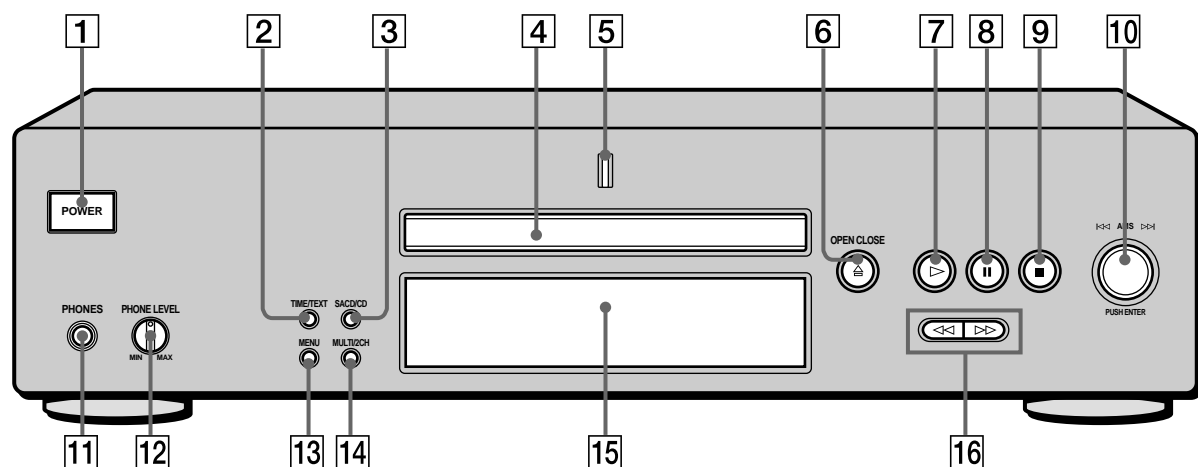

6  OPEN/CLOSE button (14)

Press to open the disc tray.

7  button (14)

Press to start play.



8  button (14)

Press to pause play.

9  button (14)

Press to stop play.

10  dial (AMS: Automatic Music Sensor) (14)

When you turn the  dial counterclockwise by one click, you go back to the preceding track; when you turn the  dial clockwise by one click, you go to the succeeding track.

11 PHONES

Connect the headphones.

During playback of a Multi-channel Super Audio CD, the same signal that is output from the ANALOG 5.1CH FRONT L/R jacks is output from the PHONES jack.

12 PHONE LEVEL

Adjust the headphones volume.

13 MENU (13)

Press to enter the menu.

Press to exit from the menu and return to the normal display.

14 MULTI/2CH button (12)

Press to select the playback area when the 2 channel + Multi-channel Super Audio CD (page 13) is loaded.

15 Display window (15)

Shows various information.

16  buttons (18)

Press to locate a portion you want to play within a track.

Rear Panel Parts Descriptions

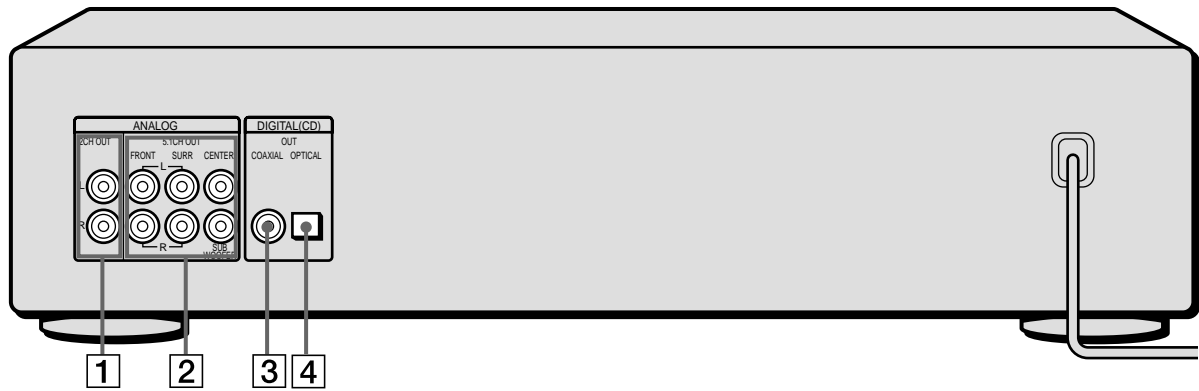

- 1 ANALOG 2CH OUT L/R jacks (6)**
Connect to an audio component (stereo/2 channel) using the audio connecting cord.
- 2 ANALOG 5.1CH OUT jacks (5)**
Connect to an amplifier equipped with the 5.1CH input jacks (Multi-channel amplifier, AV amplifier, etc.) using the audio connecting cords.
- 3 DIGITAL (CD) OUT COAXIAL connector (7)**
Connect to an audio component using the coaxial digital cable.
- 4 DIGITAL (CD) OUT OPTICAL connector (7)**
Connect to an audio component using an optical digital cable.

Note

Only the audio signals of the CD can be output from the DIGITAL (CD) OUT connectors shown in **3** and **4**. Those of the Super Audio CD cannot be output through DIGITAL (CD) OUT.

Remote Parts Descriptions

- 1 CONTINUE button (20)**
Press to resume normal play from Shuffle Play or Programme Play.
- SHUFFLE button (20)**
Press to select Shuffle Play.
- PROGRAM button (21)**
Press to select Programme Play.
- 2 DISPLAY MODE button (16)**
Press to turn off the information.
- 3 TIME/TEXT button (15)**
Each time you press the button, the playing time of the track, the total remaining time on the disc, or TEXT information appears in the display.
- 4 Number buttons (18)**
Press to enter the track numbers.
- 5 >10 button (18)**
Press to locate a track numbered over 10.
- 6 REPEAT button (19)**
Press repeatedly to play all tracks or only one track on the disc.
- 7 A↔B button (20)**
Press to select Repeat A-B Play.
- 8 ▷ button (14)**
Press to start play.
- button (14)**
Press to pause play.
- button (14)**
Press to stop play.
- 9 AMS ◀◀/▶▶ (AMS: Automatic Music Sensor) buttons (18)**
Press to locate a specific track.
- 10 ◀▶ buttons (18)**
Press to locate a portion you want to play within a track.
- 11 INDEX ◀/▶ buttons (18)**
Press to locate a specific point marked with an index signal when you play a disc that has index signals.

- 12 SACD/CD button (13)**
Each time you press the button while playing back a hybrid disc, the layer to be played back switches between the HD (Super Audio CD) layer and the CD layer.
- 13 MULTI/2CH button (12)**
Press to select the playback area when the 2 channel + Multi-channel Super Audio CD (page 13) is loaded.
- 14 ENTER button (24)**
Press to decide the selection.
- 15 CLEAR button (21)**
Press to delete a programmed track number.
- 16 LEVEL ADJ button (24)**
Press to adjust the output level balance for the Multi-channel management function (page 22).
- 17 CHECK button (21)**
Press to check the programmed order.

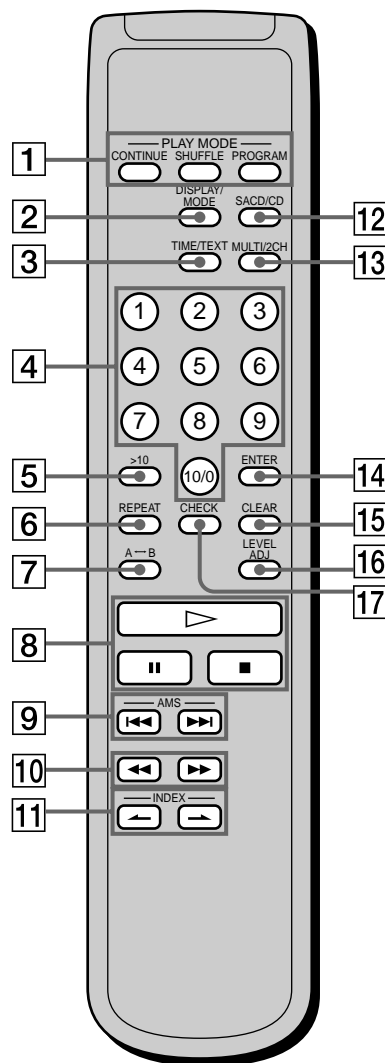

Playing Discs

This chapter explains the various ways to play discs.

Compatible Disc Types

You can play the following discs with this player. Depending on the type of disc to be played, select the appropriate indicator by pressing SACD/CD or MULTI/2CH (pages 14).

Classification by the layer configuration

Super Audio CD (single layer disc)

This disc consists of a single HD (high density) layer. When you play this disc, the player is set to the Super Audio CD playback mode automatically.

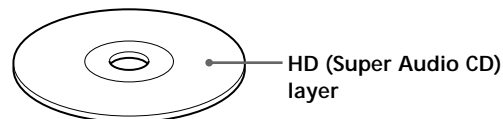

Super Audio CD (dual layer disc)

This disc consists of dual HD layers and is capable of extended play over long periods. When you play this disc, the player is set to the Super Audio CD playback mode automatically. Also, as the dual layer disc consists of dual HD layers on one side only, it is not necessary to turn the disc over.

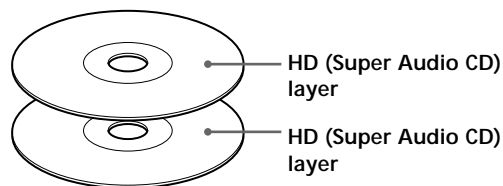

Conventional CD

This disc is the standard format. When you play this disc, the player is set to the Conventional CD playback mode automatically.

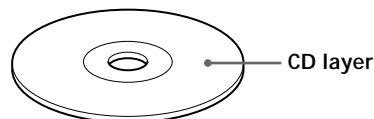

Super Audio CD + CD (Hybrid disc)

This disc consists of an HD layer and a CD layer. Press SACD/CD to select the layer you want to listen to. Also, as the dual layers are on one side, it is not necessary to turn the disc over. You can play the CD layer using a conventional CD player.

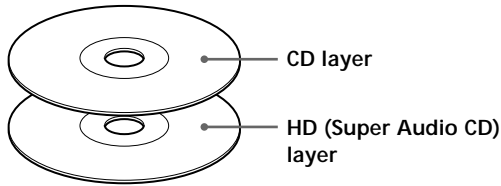

You can select the default playback layer (HD layer or CD layer).

- 1 During stop mode, press MENU.
- 2 Turn ◀◀ AMS ▶▶ until "SACD/CD SEL" appears in the display.
- 3 Press ◀◀ AMS ▶▶. The current playback layer appears.
- 4 Turn ◀◀ AMS ▶▶ to select desired playback layer, then press ◀◀ AMS ▶▶.

Classification by the channel configuration of the Super Audio CD

2 channel Super Audio CD

This disc consists of the 2 channel playback area. When you play this disc, the player is set to the 2 channel playback mode automatically.

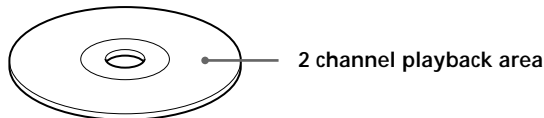

Multi-channel Super Audio CD

This disc consists of the multi-channel playback area. When you play this disc, the player is set to the multi-channel playback mode automatically.



2 channel + Multi-channel Super Audio CD

This disc consists of the 2 channel playback area and the multi-channel playback area. Press MULTI/2CH to select the playback area you want to listen to.

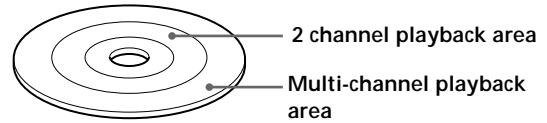

You can select the default playback area (2 channel playback or multi-channel playback area).

- 1 During stop mode, press MENU.
- 2 Turn ◀◀ AMS ▶▶ until "M/2CH SELECT" appears in the display.
- 3 Press ◀◀ AMS ▶▶. The current playback area appears.
- 4 Turn ◀◀ AMS ▶▶ to select desired playback area, then press ◀◀ AMS ▶▶.

Incompatible Discs

This player cannot play the following discs. If you try to play them, the error message "TOC Error" or "NO DISC" will appear or there will be no sound.

- CD-ROM
- DVD, etc.

Playing a Disc

The operations for normal play and the basic operations during play are explained below.

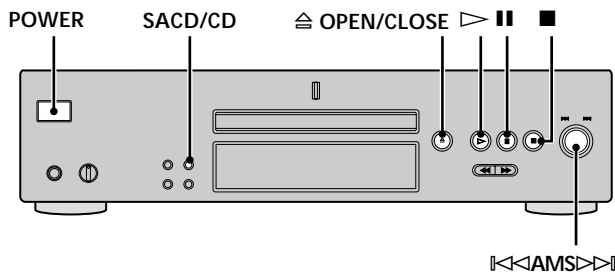

- 1 Turn on the amplifier. Turn down the volume level to the lowest.
- 2 Select the player position using the input selector on the amplifier.
- 3 Press POWER to turn on the player.
- 4 Press OPEN/CLOSE to open the disc tray, and place a disc on the tray.

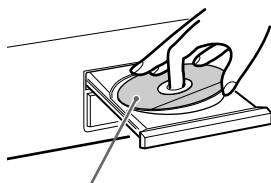

With the label side up

- 5 Press play button (right-pointing triangle). Playback starts from the first track. If you want to start playing from a specific track, turn the AMS dial to select the track number before pressing play button.
- 6 Adjust the volume on the amplifier.

Basic operations during play

To	Press
Stop play	■
Pause play	
Resume play after pausing	or ▷
Locate a succeeding track	Turn AMS dial clockwise. When using the remote, press ►►.
Locate the beginning of the current track or a preceding track	Turn AMS dial counterclockwise. When using the remote, press ◀◀.
Eject the disc	OPEN/CLOSE

💡 If you turn on the player when a disc is already loaded Playback starts automatically. If you connect a commercially available timer, you can set it to start playing the disc at any time you want.

💡 To select a layer you want to listen to when playing a hybrid disc (page 13) After you stop play using ■, press SACD/CD repeatedly to light either the "SACD" or "CD."

💡 To select a playback area you want to listen to when playing a 2 channel + Multi-channel Super Audio CD (page 13) After you stop play using ■, press MULTI/2CH repeatedly to light either the "MULTI CH" or "2 CH."

Note

During playback, increase the volume level gradually starting from the lowest level. The output from this unit may contain bandwidth that are out of the normal listening range. This may cause damage to the speakers or ears.

Using the Display

The display window shows various information about the disc or track being played. This section describes the current disc information and information that appears for each play status.

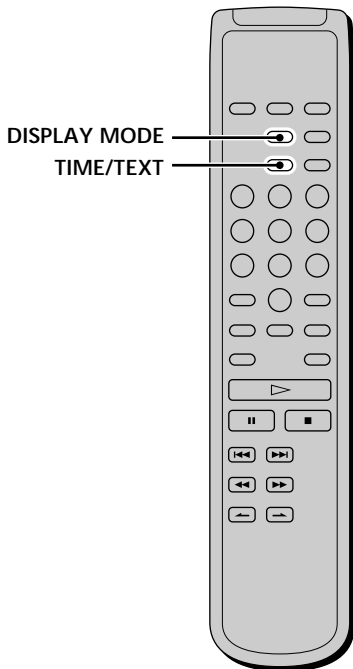
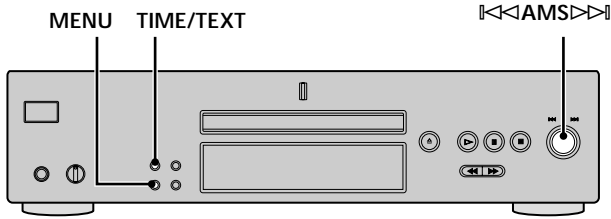

Disc information when a disc is loaded

Depending on the disc that is currently loaded, the display shows as follows:

2 channel Super Audio CD

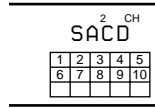

Multi-channel Super Audio CD

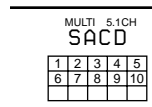

or

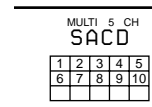

or

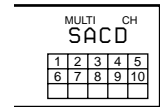

During playback a 5.1 channel Super Audio CD

During playback a 5 channel Super Audio CD

During playback other Super Audio CDs or during stop mode

Conventional CD

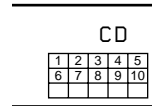

Playing Discs

Displaying information while the player is stopped

Press TIME/TEXT.

The display shows the total number of tracks and total playing time.

Total number of tracks Total playing time



Using the Display

Displaying information while the player is playing

Press TIME/TEXT.

Each time you press the button, the current track number and its elapsed time or remaining time appears, or the total remaining time for the disc appears in the display. When the player detects a Multi-channel Super Audio CD, the channel information appears before the default display appears.

Playing track number and elapsed playing time of the current track (default display)

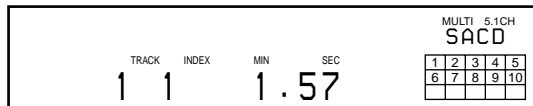

Press TIME/TEXT

Playing track number and remaining time of the current track

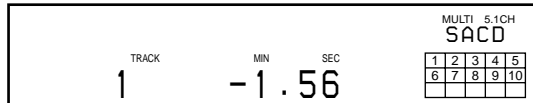

Press TIME/TEXT

Total remaining time on the disc

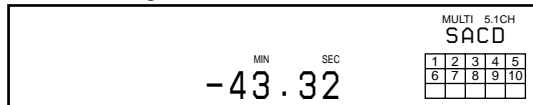

Press TIME/TEXT

Channel information (appears only when the player detects a Multi-channel Super Audio CD)

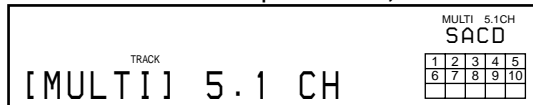

Turning off the information in the display



Each time you press DISPLAY MODE on the remote while playing a disc, the display turns off and on alternately. Even when the display is turned off, the display turns on if you pause or stop play. When you resume play, the display turns off again.

Before you start playing, when you press DISPLAY MODE to turn off the display, "DISPLAY OFF" appears, and when you press the button to turn on the display, "DISPLAY ON" appears.

Displaying the information of a TEXT disc

TEXT discs contain information, such as the disc name or artist name, as well as the audio signals. This player can display the disc name, artist name, and current track name as TEXT information.

When the player detects a TEXT disc, "TEXT" appears in the display. If your TEXT disc has several languages, "MULTI-TEXT" appears in the display. When you want to check the information in another language, see "Displaying the information of a TEXT disc in other languages" on page 17.

Displaying the information of a TEXT disc in stop mode

Press TIME/TEXT.

Each time you press the button, the disc name or artist name appears in the display. When you select the artist name, "ART." appears in the display.

- Before you start playing

Disc title



Press TIME/TEXT

Artist name



Press TIME/TEXT

Total number of tracks and total playing time



Press
TIME/
TEXT

Display information of a TEXT disc while playing a disc

The current track name appears. If the disc name has more than 15 characters, the first 14 characters will remain after the name scrolls by in the display.

When the player detects a Multi-channel Super Audio CD, the channel information appears before the playing time of the current track appears.

- While playing a disc

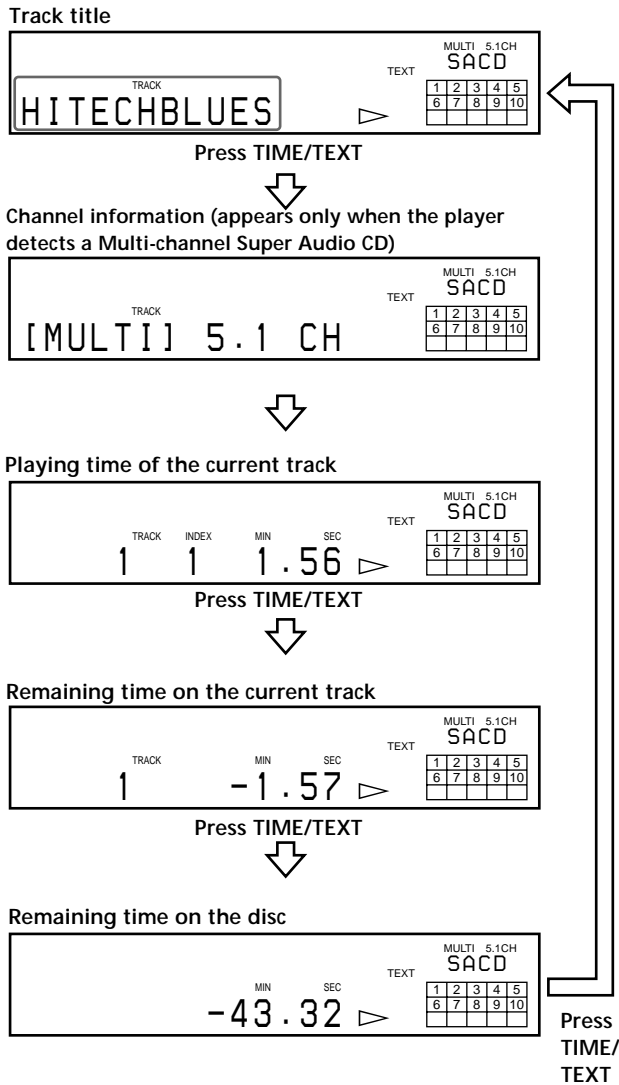

Notes

- The display may not show all the characters, depending on the disc.
- This player can display only the disc name, artist name, and track names from TEXT discs. Other information cannot be displayed.

Displaying the information of a TEXT disc in other languages

You can change the displayed language if the TEXT disc has multi language capacity. When the player detects such a TEXT disc, "MULTI-TEXT" appears in the display. Change the language according to the procedures below.

- 1 Press MENU in stop mode.
- 2 Turn \lll AMS \ggg until "LANGUAGE" appears in the display.
- 3 Press \lll AMS \ggg .
The current selected language (English, French, German, etc.) flashes.
If the player cannot display the language used in a TEXT disc, "Other Lang" appears in the display.
- 4 Turn \lll AMS \ggg until the desired language appears in the display.
- 5 Press \lll AMS \ggg .
After a few seconds, the information appears in the selected language.

Locating a Specific Track

During stop or play mode, you can locate any track to be played.

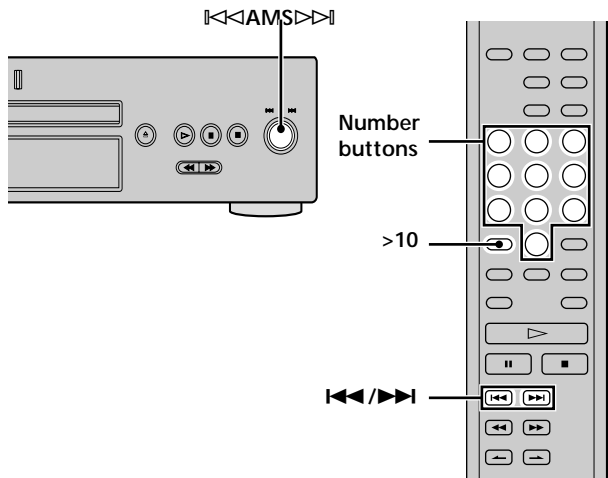

To locate	You need to
The next or succeeding tracks	Turn AMS clockwise until you find the track. When using the remote, press ▶▶ repeatedly until you find the track.
The current or preceding tracks	Turn AMS counterclockwise until you find the track. When using the remote, press ◀◀ repeatedly until you find the track.
A specific track directly	Turn AMS until you find the track number you want. When using the remote, press ◀◀ or ▶▶ repeatedly until you find the track.

Locating a track directly by entering the track number

Press the number button(s) to enter the track number.

To enter a track number over 11

- 1 Press **>10**.
- 2 Enter the corresponding digits.
To enter 0, press **10/0** instead.

Examples:

- To play track number 30, press **>10**, then 3 and **10/0**.
- To play track number 100, press **>10** twice, then 1, and **10/0** twice.

Locating a Particular Point in a Track

You can locate a particular point in a track during play or play pause.

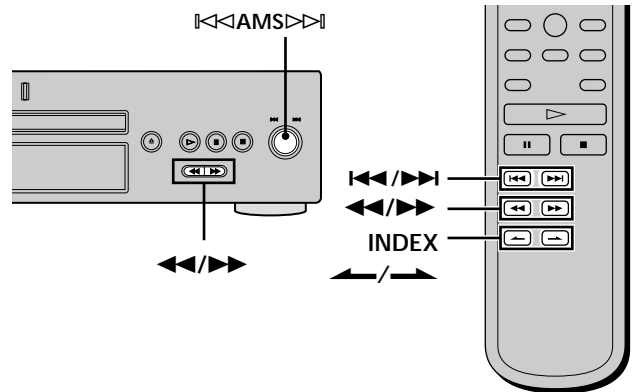

Locating a point while monitoring the sound (Search)

Press and hold **SEARCH** during play. You will hear intermittent playback as the disc goes forward or reverses. When you reach the desired point, release the button.

Locating a point by observing the time indication (High-Speed Search)

Press and hold **SEARCH** during play pause. You will not hear the playback sound.

When "Over!!" appears in the display The disc has reached its end. Press **◀◀** or **▶▶** to go back.

Note

Tracks that are only a few seconds long may be too short for monitoring. In this case, the player may not search correctly.

Locating a point using the index function (Index Search)

Press **INDEX** or **INDEX** repeatedly in play or pause mode.

What is an INDEX?

Some Super Audio CD or CD are provided with an index marking system which divides tracks or discs into smaller segments. This is especially useful when you want to locate a certain point within a long track (in classical music for example). The index search function works only when you use a commercially available indexed disc (usually indicated on the label).

Locating a point by setting the start time (Time Search)

- 1 Press **⏮/⏭** (or turn **⏮ AMS ⏭**) to select the desired track in stop mode.
- 2 Press and hold **⏮/⏭** to set the time to start play while looking at the display.
You can set the time from the beginning of the desired a track when you press **⏭** at first, and set the time from the end of the desired track backward's when you press **⏮** at first.



- 2 Press **▷**.
Play will start at the time search.

Playing Tracks Repeatedly



You can play an entire disc or portions thereof repeatedly. This function can be used with Shuffle Play to repeat all the tracks in random order (page 20), or with Programme Play to repeat all the tracks in a programme (page 21). You can also repeat a specific track or portion within a track.

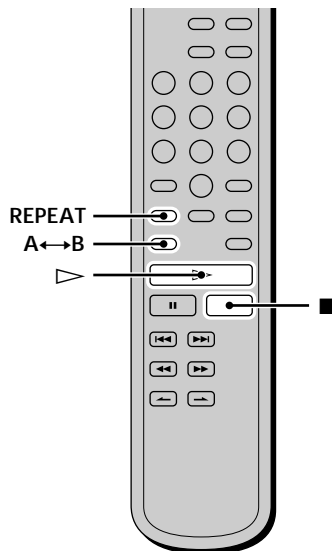

Note

If you turn off the player or disconnect the mains lead, the player will store the last setting of repeat play ("Repeat All" or "Repeat 1") and recall it the next time you turn on the player. However, the setting of the Repeat A-B Play will be cancelled if you turn off the player or disconnect the mains lead.

Repeating all the tracks on the disc (Repeat All Play)

Press **REPEAT** once, then press **▷**.

"REPEAT" appears in the display and Repeat All Play starts.

The repeat play changes depending on the play mode you select.

When the play mode is	The player repeats
Normal play (page 14)	All the tracks in sequence
Shuffle Play (page 20)	All the tracks in random order
Programme Play (page 21)	All the tracks in the programme in sequence

To cancel Repeat All Play

Press **REPEAT** repeatedly until "REPEAT" goes off.

Playing Tracks Repeatedly

Repeating the current track (Repeat 1 Play)

While the track you want to repeat is being played, press REPEAT repeatedly until "REPEAT 1" appears in the display.

Repeat 1 Play starts.

To cancel Repeat 1 Play

Press REPEAT repeatedly until "REPEAT 1" goes off.

Repeating a specific portion within a track (Repeat A-B Play)

You can specify one portion within a track to be played repeatedly. Note that the portion that you specify must be within the boundaries of a single track.

- 1 While the player is playing, press A↔B at the starting point (point A) of the portion to be played repeatedly.
"REPEAT" appears and "A" flashes in the display.
- 2 Continue playing the track (or press ►►) to locate the ending point (point B), then press A↔B.
"REPEAT A-B" appears and Repeat A-B Play starts.

To cancel Repeat A-B Play

Press REPEAT.

 You can set a new starting point and ending point during Repeat A-B Play

You can change the current ending point to a new starting point, then specify a new ending point to repeat another portion right after the current portion.

- 1 During Repeat A-B Play, press A↔B.
The current ending point changes to the new starting point (point A).
"REPEAT" lights up and "A" flashes in the display.
- 2 Locate the new ending point (point B) and press A↔B.
"REPEAT A-B" lights up and the player starts to repeat the newly specified portion.

When you want to restart from the starting point A, press ► during A↔B repeat.

Playing Tracks in Random Order (Shuffle Play)

When you select Shuffle Play, the player plays all the tracks on the disc in random order.

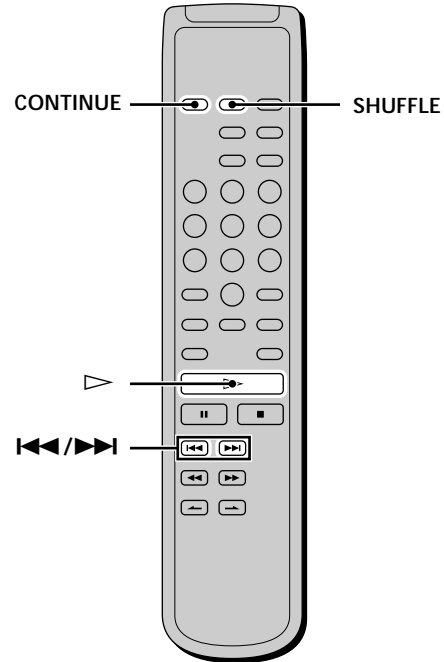

- 1 Press SHUFFLE in stop mode.
- 2 Press ►.
Shuffle Play starts.
"◻" appears while the player is "shuffling" the tracks.
The player will stop after playing all the tracks once.

To resume normal play

Press CONTINUE.

 You can locate tracks during Shuffle Play

Press ◀◀/▶▶.

Press ▶▶ to locate the next track or press ◀◀ to locate the beginning of the current track. The player does not go back to tracks which have already been played.

Creating Your Own Programme (Programme Play)

You can pick out the tracks that you like and specify the playback order in a programme containing up to 32 tracks (or 999 min. 59 sec. in total programme time)

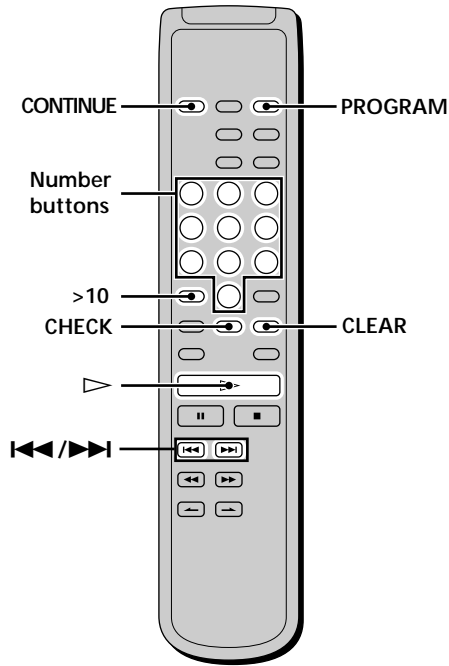

- 1 Press **PROGRAM** in stop mode.
"PROGRAM" appears in the display.
- 2 Press the number buttons to enter the track number.

If you entered the wrong track number
Press **CLEAR** to erase the track number and reenter the correct track number using the number buttons.

To select a track number over 11
Press **>10** (page 18).

- 3 Repeat step 2 to enter other tracks.
Each time you enter a track number, the total programme time appears in the display.
- 4 Press **▷**.
Programme Play starts.

To resume normal play
Press **CONTINUE**.

 The programme remains even after Programme Play ends
Press **▷** to play from the beginning of the programme again.
The programme remains even if you stop play.

Note
If you turn off the player, disconnect the mains lead, or press **≡ OPEN/CLOSE**, the programme will be erased.

Checking the contents of the programme

Before you start playing or while the player is playing, press **CHECK**.

Each time you press the button, the track numbers will appear in the display in the programmed order.

When you press **CHECK** while the player is playing, the track number appears from the next track numbers of the current playing track number.

Changing the contents of the programme

You can change the contents of the programme in stop mode.

To	Do the following:
Erase a track	<ol style="list-style-type: none"> 1 Press CHECK repeatedly until the track number you want to erase appears. 2 Press CLEAR.
Erase from the last track in the programme	Press CLEAR . Each time you press the button, the last track of the programme is erased.
Add a track to the end of the programme	Press ◀◀/▶▶ to select the track you want to add, then press PROGRAM . When using the remote, press the number button of the track to be added.
Erase all tracks	Hold down CLEAR or ■ (for about 2 seconds) until "Prog CLEAR" appears in the display.

Listening to a Multi-channel Super Audio CD

(Multi-channel management function)

This player is equipped with a Multi-channel management function that sets the playback mode of the Super Audio CD by the DSD-DSP (built into the player) according to the layout or size of your speaker.

Example of the speaker layout

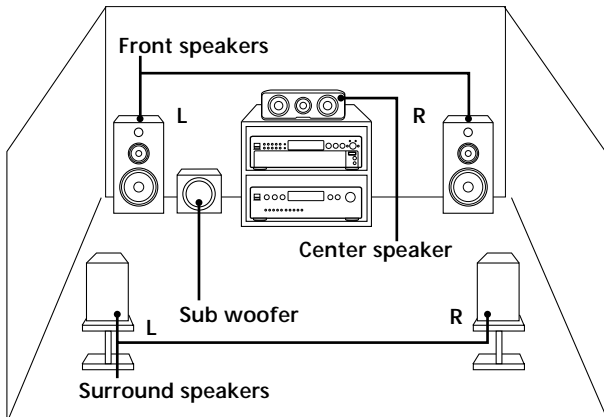

To set the Multi-channel management:

- 1 Select the appropriate preset playback mode (2 channel playback or Multi-channel playback).
- 2 Adjust the output level balance of each speaker (only when you select the Multi-channel playback mode).

Notes

- This features only work when you play the Super Audio CD.
- You may not be able to adjust the output level balance depending on the speaker layout mode that you selected.

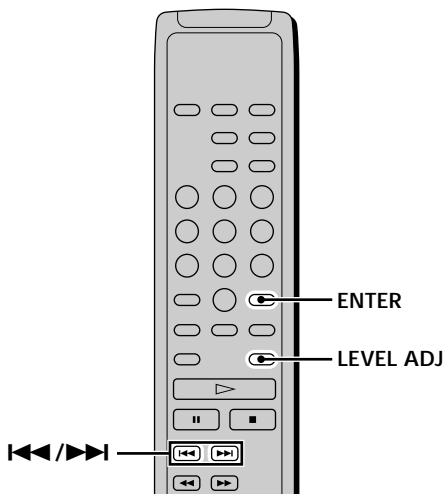
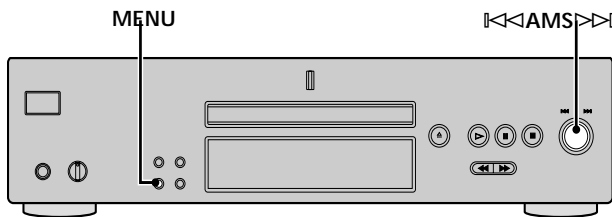

Selecting 2 channel playback mode

- 1 Press MENU.
- 2 Turn **AMS** until "2CH SPK MODE" appears in the display.
- 3 Press **AMS**.
The playback mode appears in the display.

Playback mode	Front speakers	Sub woofer
2CH Direct	Each signal outputs directly from front speakers. No signal outputs from the Sub woofer.	
2CH + SW	○	○

- 4 Turn **AMS** until desired mode appears in the display.
- 5 Press **AMS**.
To return to the normal display, press MENU.

Note

You cannot operate this function when the player is in the CD or Multi-channel playback mode. Operate this function when the player is in the 2 channel Super Audio CD playback mode, the disc tray is opened, or no discs are in the player.

Selecting Multi-channel playback mode

- 1 Press MENU.
- 2 Turn **AMS** until "MCH SPK MODE" appears in the display.
- 3 Press **AMS**.
The playback mode appears in the display.

Playback mode	Front speakers	Center speaker	Surround speakers	Sub woofer
MCH Direct	Each signal outputs directly from each speaker.			
5 - Large + SW	Large	Large	Large	○
5 - Large	Large	Large	Large	--
5 - Small + SW	Small	Small	Small	○
FRT - Large + SW	Large	Small	Small	○
FRT - Large	Large	Small	Small	--
No - CNTR + SW	Large	--	Large	○
No - CNTR	Large	--	Large	--

About “Large” or “Small” speaker

A “Large” speaker is a speaker that can reproduce bass frequencies plentifully. If you select “Small” for the surround speakers, the bass frequencies will come from the front speakers and/or sub woofer.

For normal use, select “MCH Direct” or set all the speakers to “Large” (ex. “5 – Large + SW,” “5 – Large,” etc.). If the sound is noisy or the Multi-channel playback is not effective while playing a Multi-channel Super Audio CD, change the settings of the speakers concerned to “Small.”

4 Turn ◀◀ AMS ▶▶ until desired mode appears in the display.

5 Press ◀◀ AMS ▶▶.

To return to the normal display, press MENU.

Notes

- The Multi-channel management function does not work when you select “MCH Direct” (you cannot set the output level balance of each speaker).
- The front speaker setting is set to “Large” automatically when you set the Sub woofer to “--.”
- When you play a track that does not contain the LFE* signal, the signal for the Sub woofer does not output. Therefore, when you select “MCH Direct,” “5 – Large + SW,” or “No – CNTR + SW,” no signal outputs from the Sub woofer. However, when you select “5 – Small + SW” or “FRT – Large +SW” (when you set the speaker setting to “Small”), the bass frequencies will come from the sub woofer.
* Low Frequency Enhancement (described as “.1 CH”)
- You cannot operate this function when the player is in the CD or Multi-channel playback mode. Operate this function when the player is in the 2 channel Super Audio CD playback mode, the disc tray is opened, or no discs are in the player.
- If you select a playback mode other than “2CH Direct” or “MCH Direct” using the Multi-channel management function, the sound distribution to the speakers will change, possibly causing a decrease in overall sound volume. If this occurs, adjust the volume with the volume control on the connected amplifier.

Adjusting the output level balance of each speaker

You can adjust following items with the Multi-channel management function:

CNTR BALANCE

The relative output level balance between the front speakers (FRONT L/R) and the center speaker (CENTER)

SURR BALANCE

The relative output level balance between the front speakers (FRONT L/R) and the surround speakers (SURR L/R)

SW BALANCE

The relative output level balance between the front speakers (FRONT L/R) and the sub woofer (SUB WOOFER)

Note

Some adjustment may not work depending on the Multi-channel playback mode that you selected.

Adjusting the output level balance on the front panel of the player

You can adjust the output level balance of each speaker while listening during playback. You can also adjust while listening to the test tone during stop mode.

1 Press MENU.

2 Turn ◀◀ AMS ▶▶ until “LEVEL ADJUST” appears in the display.

3 Press ◀◀ AMS ▶▶.

During playback, go to Step 6.

4 Turn ◀◀ AMS ▶▶ until “TONE ON” appears in the display.

- Press **◀◀ AMS ▶▶**.
The test tone issues from the speakers in sequence with the speaker type appearing in the display.
- Turn **◀◀ AMS ▶▶** until the desired item appears in the display.
Select the item from “CNTR BALANCE,” “SURR BALANCE,” or “SW BALANCE.”

Note
When you set the Sub woofer to “--” in the Multi-channel playback mode (page 22), “SW BALANCE” cannot be selected. Similarly, “CNTR BALANCE” or “SURR BALANCE” cannot be selected when you set the corresponding speaker to “--.”

- Press **◀◀ AMS ▶▶**.
The balance adjustment display appears.
In stop mode, the test tone is output from the selected speaker.
Example: When you select “SURR BALANCE” during stop mode, the test tone is output from the front speakers and surround speakers.

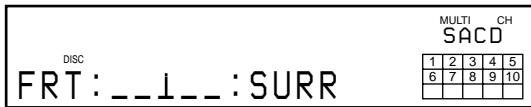

- Turn **◀◀ AMS ▶▶** to adjust the output level.

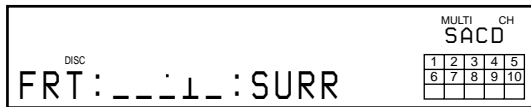

- Press **◀◀ AMS ▶▶**.
The player status returns to Step 6.
Repeat Step 6 through 9 for more adjustments.

- Press **MENU** after you finish adjusting.
The display returns to the normal display.

Adjusting the output level from the remote 
You can adjust the output level of each speaker from the listening position by using the supplied remote.

- Press **LEVEL ADJ** during playback or stop mode.
During playback, go to Step 4.

- Press **◀◀/▶▶** repeatedly until “TONE ON” appears in the display.
- Press **ENTER**.
The test tone issues from the speakers in sequence with the speaker type appearing in the display.
- Press **◀◀/▶▶** repeatedly until the desired item appears in the display.
Select the item from “CNTR BALANCE,” “SURR BALANCE,” or “SW BALANCE.”

Note
When you set the Sub woofer to “--” in the Multi-channel playback mode (page 22), “SW BALANCE” cannot be selected. Similarly, “CNTR BALANCE” or “SURR BALANCE” cannot be selected when you set the corresponding speaker to “--.”

- Press **ENTER**.
The balance adjustment display appears.
In stop mode, the test tone is output from the selected speaker.
Example: When you select “SURR BALANCE” during stop mode, the test tone is output from the front speakers and surround speakers.

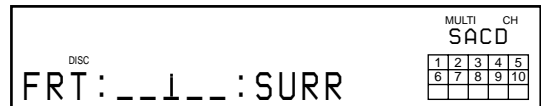

- Press **◀◀/▶▶** repeatedly to adjust the output level.

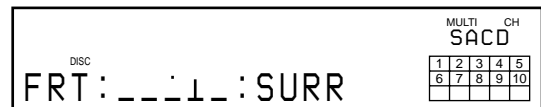

- Press **ENTER**.
The player status returns to Step 4.
Repeat Step 4 through 7 for more adjustments.
- Press **LEVEL ADJ** after you finish adjusting.
The display returns to the normal display.

Additional Information

This chapter provides additional information that will help you understand and maintain your Super Audio CD player.

Precautions

On safety

- Caution — The use of optical instruments with this product will increase eye hazard.
- Should any solid object or liquid fall into the cabinet, unplug the player and have it checked by qualified personnel before operating it any further.
- AC power cord must be changed only at the qualified service shop.
- The unit is not disconnected from the AC power source (mains) as long as it is connected to the wall outlet, even if the unit itself has been turned off.

On power sources

- Before operating the player, check that the operating voltage of the player is identical with your local power supply. The operating voltage is indicated on the nameplate at the rear of the player.
- The player is not disconnected from the mains as long as it is attached to the mains, even if the player itself has been turned off.
- If you are not going to use the player for a long time, be sure to disconnect the player from the mains. To disconnect the mains lead, grasp the plug itself; never pull the cord.

On placement

- Place the player in a location with adequate ventilation to prevent heat build-up in the player.
- Do not place the player on a soft surface such as a rug that might block the ventilation holes on the bottom.
- Do not place the player in a location near heat sources, or in a place subject to direct sunlight, excessive dust or mechanical shock.

On operation

- If the player is brought directly from a cold to a warm location, or is placed in a very damp room, moisture may condense on the lenses inside the player. Should this occur, the player may not operate properly. In this case, remove the disc and leave the player turned on for about an hour until the moisture evaporates.
- During power on, some noise may be heard while the disc is being loaded into the Super Audio CD player. This is not a malfunction.

On adjusting the volume

- Do not turn up the volume too much while listening to a portion with very low level inputs or no audio signals. If you do, the speakers may be damaged when a peak level portion is played.

Precautions

On inserting a disc

- You may hear a transmission or a mechanical sound from the player. This indicates that the player is automatically adjusting its internal mechanisms according to the inserted disc. You may also hear the mechanical sound from the player when you insert a warped disc.

On cleaning

- Clean the cabinet, panel, and controls with a soft cloth slightly moistened with a mild detergent solution. Do not use any type of abrasive pad, scouring powder, or solvent such as alcohol or benzine.

On transportation

- Be sure to remove the disc on the tray.
- Be sure to close the disc tray.

If you have any questions or problems concerning your player, please consult your nearest Sony dealer.

Notes on Discs

On handling discs

- To keep the disc clean, handle the disc by its edge. Do not touch the surface.
- Do not stick paper or tape on the disc.

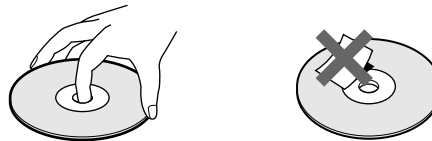

- Use only round-shaped discs. If you use a special shaped disc (e.g., star-shaped, heart-shaped, or square-shaped, etc.), the player may be damaged.
- Do not use a disc with a seal attached on such as on a used disc or rental disc.

On keeping discs

- Do not expose the disc to direct sunlight or heat sources such as hot air ducts.
- After playing, store the disc in its case. If you put it on top of another disc without the case, the disc may be damaged.

On placing discs on the disc tray

- Make sure the disc is positioned securely on the tray. If not, the player or the disc may be damaged.

On cleaning

- If the disc is dirty with fingerprints or dust, it may lessen the quality of the audio out.
- Before playing, clean the disc with a cleaning cloth. Wipe the disc from the centre out.

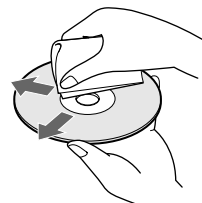

- Clean the disc with a soft cloth slightly moistened with water, and remove moisture with a dry cloth.
- Do not use solvents such as benzine, thinner, record cleaners, or anti-static spray.

Notes on CD-R/CD-RW playback

- Discs recorded on CD-R/CD-RW drives may not be played back because of scratches, dirt, recording condition, or the drive's characteristics. Besides, the discs, which are not yet finalized at the end of recording, cannot be played back.

Troubleshooting

If you experience any of the following difficulties while using the player, use this troubleshooting guide to help you remedy the problem. Should any problem persist, consult your nearest Sony dealer.

There is no sound.

- ➔ Check that the player is connected securely.
- ➔ Make sure you operate the amplifier correctly.
- ➔ When you use the headphones, adjust the volume with PHONE LEVEL.

There is no sound from the DIGITAL (CD) OUT connectors.

- ➔ The audio signals of the super audio CD cannot be output from the DIGITAL (CD) OUT connectors.

The disc does not play.

- ➔ There is no disc inside the player.
- ➔ The disc is placed upside down on the tray.
- ➔ Place the disc on the disc tray with the label side up.
- ➔ The disc is placed at an angle. Reload the disc.
- ➔ Clean the disc (see page 26).
- ➔ Moisture has condensed inside the player. Remove the disc and leave the player turned on for about an hour.
- ➔ There is an incompatible disc on the tray (see page 13).

The remote does not function.

- ➔ Remove any obstacles in the path of the remote and the player.
- ➔ Point the remote at the remote sensor on the player.
- ➔ If the batteries in the remote are weak, replace with new ones.

There is no sound from the SUB WOOFER jack.

- ➔ Select a playback mode in which a sub woofer signal is output from the SUB WOOFER jack. The mode indication is displayed with "+SW" (page 22) when such a mode is selected.
- ➔ When you play a track that does not contain the LFE signal, the signal outputs from the SUB WOOFER jack only when you select "5 - Small + SW" or "FRT - Large + SW" for the Multi-channel playback mode (page 22).

Specifications

When a super audio CD is played

Playing frequency range	2 Hz to 100 kHz
Frequency response	2 Hz to 50 kHz (-3 dB)
Dynamic range	104 dB or more
Total harmonic distortion rate	0.0018 % or less
Wow and flutter	Value of measurable limit (± 0.001 % W. PEAK) or less

When a CD is played

Frequency response	2 Hz to 20 kHz
Dynamic range	99 dB or more
Total harmonic distortion rate	0.002 % or less
Wow and flutter	Value of measurable limit (± 0.001 % W. PEAK) or less

Output connector

	Jack type	Output level	Load impedance
ANALOG OUT	Phono jacks	2 Vrms (at 50 kilohms)	Over 10 kilohms
DIGITAL (CD) OUT OPTICAL*	Square optical output connector	-18 dBm	(Light emitting wave length: 660 nm)
DIGITAL (CD) OUT COAXIAL*	Coaxial output connector	0.5 Vp-p	75 ohms
PHONES	Stereo phone jack	10 mW	32 ohms

*Output only the audio signals of the CD

General

Laser	Semiconductor laser (Super Audio CD: $\lambda = 650$ nm) (CD: $\lambda = 780$ nm) Emission duration: continuous
Laser radiant power:	5.47 μ W at 650 nm
*These output is the value measured at a distance of about 200mm from the objective lens surface on the optical pick-up.	
Power requirements	230 V AC, 50/60 Hz
Power consumption	25 W
Dimensions (w/h/d)	430 \times 111 \times 283 mm incl. projecting parts
Mass (approx.)	5.8 kg

Supplied accessories

See page 4.

Design and specifications are subject to change without notice.

Index

A

- Accessories 4
- Amplifier (not supplied) 5
- AMS (Automatic Music Sensor) 14
- ANALOG OUT
 - 2CH 6
 - 5.1CH 5

B

- Batteries 4

C

- Cable
 - Coaxial digital 7
 - Optical digital 7
- Cord
 - Audio connecting 5

D, E, F, G

- DIGITAL (CD) OUT 7
- Displaying information 15

H, I, J, K

- Hooking Up
 - Audio Components 5
 - Power 7

L

- Locating
 - a specific track 18
 - a particular point 18
 - by entering the track number 18
 - by observing the time indication (High-speed Search) 18
 - using the index function (Index Search) 18
 - while monitoring the sound (Search) 18

M, N

- Multi-channel management function 22
- Multi-channel Super Audio CD 13

O

- Output level balance 23

P, Q

- Pause play 14
- Place a disc 14
- Playback mode
 - 2 channel 22
 - Multi-channel 22
- Playing
 - a disc 14
 - by entering the track number 18
 - Multi-channel Super Audio CD 22
 - repeatedly 19
 - track in random order 20
- Programme Play
 - Checking the contents of the programme 21
 - Changing the contents of the programme 21
 - how to create your own programme 21

R

- Remote commander (remote) 11
- Repeat
 - A-B Play 20
 - All Play 19
 - 1 Play 20

S

- Search
 - High-speed search 18
 - Index search 18
 - Time Search 19
- Shuffle Play 20
- Super Audio CD 12

T, U, V, W, X, Y, Z

- TEXT 16
- TOC 13