

FM Stereo FM-AM Receiver

Operating Instructions

STR-DB780

WARNING

To prevent fire or shock hazard, do not expose the unit to rain or moisture.

To prevent fire, do not cover the ventilation of the apparatus with news papers, table-cloths, curtains, etc. And don't place lighted candles on the apparatus.

To prevent fire or shock hazard, do not place objects filled with liquids, such as vases, on the apparatus.



Don't throw away the battery with general house waste, dispose of it correctly as chemical waste.

Do not install the appliance in a confined space, such as a bookcase or built-in cabinet.

Except for European model



ENERGY STAR® is a U.S. registered mark.
As an ENERGY STAR® partner, Sony Corporation has determined that this product meets the ENERGY STAR® guidelines for energy efficiency.

About This Manual

- The instructions in this manual are for model STR-DB780. Check your model number by looking at the lower right corner of the front panel. In this manual, the models of area code U is used for illustration purposes unless stated otherwise. Any difference in operation is clearly indicated in the text, for example, “Models of area code U only”.
- The instructions in this manual describe the controls on the receiver. You can also use the controls on the supplied remote if they have the same or similar names as those on the receiver. For details on the use of your remote:
 - Models of area code U, CA
RM-PP506L: See the separate operating instructions supplied with the remote.
 - Models of other area codes
RM-U305C: See pages 53–56.

About area codes

The area code of the receiver you purchased is shown on the lower portion of the rear panel (see the illustration below).

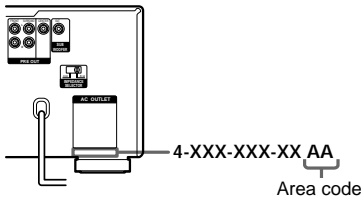

Any differences in operation, according to the area code, are clearly indicated in the text, for example, “Models of area code AA only”.

This receiver incorporates Dolby* Digital and Pro Logic Surround and the DTS** Digital Surround System.

- * Manufactured under license from Dolby Laboratories.
“Dolby”, “Pro Logic” and the double-D symbol are trademarks of Dolby Laboratories.
- ** “DTS” and “DTS Digital Surround” are registered trademarks of Digital Theater Systems, Inc.

Table of Contents

List of Button Locations and Reference Pages

Main unit	6
-----------------	---

Getting Started

1: Check how to hookup your components	8
1a: Connecting components with digital audio output jacks	10
1b: Connecting components with multi channel output jacks	13
1c: Connecting components with only analog audio jacks	15
2: Connecting the antennas	17
3: Connecting speakers	18
4: Connecting the AC power cord	20
5: Setting up the speakers	21
6: Adjusting the speaker levels and balance (TEST TONE)	23

Amplifier/Tuner Operation

Selecting the component	24
Listening to multi channel sound (MULTI CH DIRECT)	24
Listening to FM/AM radio	25
Storing FM stations automatically (AUTOBETICAL)* ¹	26
Presetting radio stations	26
Using the Radio Data System (RDS)* ¹	27
Changing the display	30
About the indications in the display	31

Enjoying Surround Sound

Automatically decoding the input audio signal (AUTO DECODING)	33
Using only the front speakers (2CH STEREO)	33
Selecting a sound field	34
Enjoying Dolby Pro Logic II (2CH MODE)	36

Advanced Adjustments and Settings

Switching the audio input mode for digital components (INPUT MODE)	37
Customizing sound fields	37
Adjusting the equalizer	39
Advanced settings	40

Other Operations

Naming preset stations and functions ..	47
Using the Sleep Timer	47
Recording	48
CONTROL A1 II control system	49

Operations Using the Remote RM-U305C*²

Before you use your remote	53
Remote button description	53
Changing the factory setting of a function button	56

Additional Information

Precautions	57
Troubleshooting	57
Specifications	60
Index	63

*¹ Models of area code CEL, CEK only.

*² Except for models of area code U, CA.

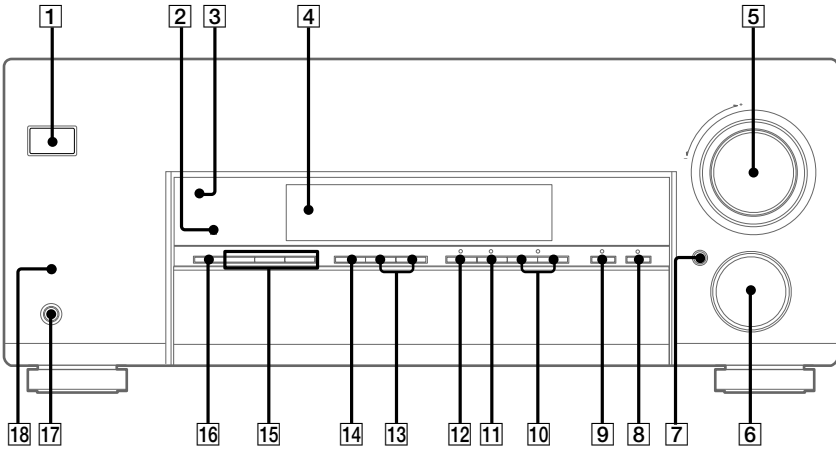

Open the front door

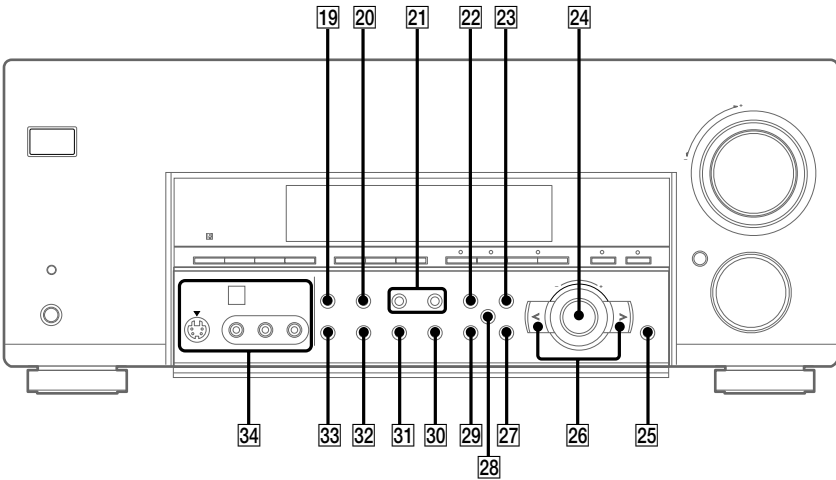

1: Check how to hookup your components

Steps 1a through 1c beginning on page 10 describe how to hook up your components to this receiver. Before you begin, refer to “Connectable components” below for the pages which describe how to connect each component.

After hooking up all your components, proceed to “2: Connecting the antennas” (page 17).

Connectable components

Component to be connected	Page
DVD/LD player	
With digital audio output* ¹	10–11
With multi-channel audio output* ²	13–14
With analog audio output only* ³	10–11
TV monitor	
With component video input* ⁴ * ⁵	11 or 14
With S-Video or composite video input only	16
Satellite tuner	
With digital audio output* ¹	10–11
With analog audio output only* ³	10–11
CD/Super Audio CD player	
With digital audio output* ¹	12
With multi-channel audio output* ²	13
With analog audio output only* ³	15
MD/Tape deck	
With digital audio output* ¹	12
With analog audio output only* ³	15
Analog disc turntable	15
Multi-channel decoder	13
VCR, video camera, video game, etc.	16

*¹ Model with a DIGITAL OPTICAL OUTPUT or DIGITAL COAXIAL OUTPUT connector, etc.

*² Model with a MULTI CH OUTPUT connectors, etc. This connection is used to output the audio decoded by the component’s internal multi-channel decoder through this receiver.

*³ Model equipped only with AUDIO OUT L/R jacks, etc.

*⁴ Model with component video (Y, B-Y, R-Y) input jacks

*⁵ Except for models of area code CEL, CEK.

Required cords

The hookup diagrams on the subsequent pages assume the use of the following optional connection cords (**A** to **H**) (not supplied).

A Audio cord

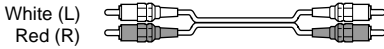

B Audio/video cord

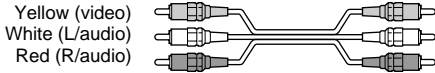

C Video cord



D S-video cord



E Optical digital cord



F Coaxial digital cord



G Monaural audio cord



Tip

Audio cord **A** can be torn into two monaural audio cords **G**.

H Component video cord

(Except for models of area code CEL, CEK)

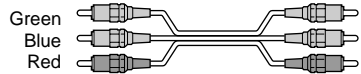

Notes

- Turn off the power to all components before making any connections.
- Be sure to make connections firmly to avoid hum and noise.
- When connecting an audio/video cord, be sure to match the color-coded pins to the appropriate jacks on the components: yellow (video) to yellow; white (left, audio) to white; and red (right, audio) to red.
- When connecting optical digital cords, insert the cord plugs straight in until they click into place.
- Do not bend or tie optical digital cords.

If you have a Sony components with CONTROL A1 II jack

See “CONTROL A1 II control system” on page 49.

1a: Connecting components with digital audio output jacks

Hooking up a DVD player, LD player, TV, or satellite tuner

For details on the required cords (**A**–**H**), see page 9.

1 Connect the audio jacks.

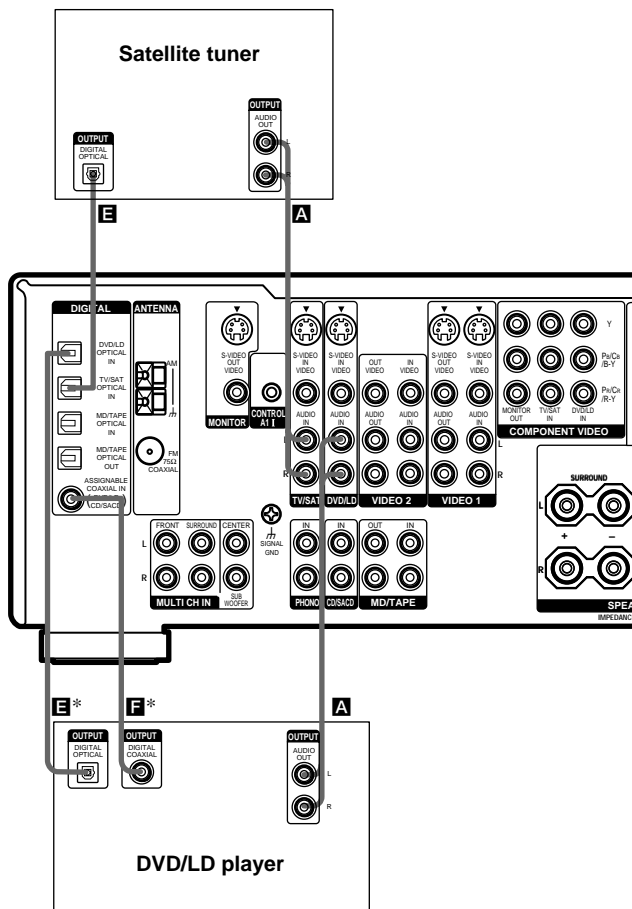

* Connect to either the ASSIGNABLE COAXIAL IN (DVD/LD CD/SACD) or the DVD/LD OPTICAL IN jack. We recommend making connections to the ASSIGNABLE COAXIAL IN (DVD/LD CD/SACD) jack.

2 Connect the video jacks.
(Except for models of area code CEL, CEK)

The following illustration shows how to connect a TV or satellite tuner and a DVD/LD player with COMPONENT VIDEO (Y, B-Y, R-Y) output jacks. Connecting a TV with component video input jacks allows you to enjoy higher quality video.

Note

On this receiver, the component video signals cannot be converted to S-video or standard video signals (or vice versa).

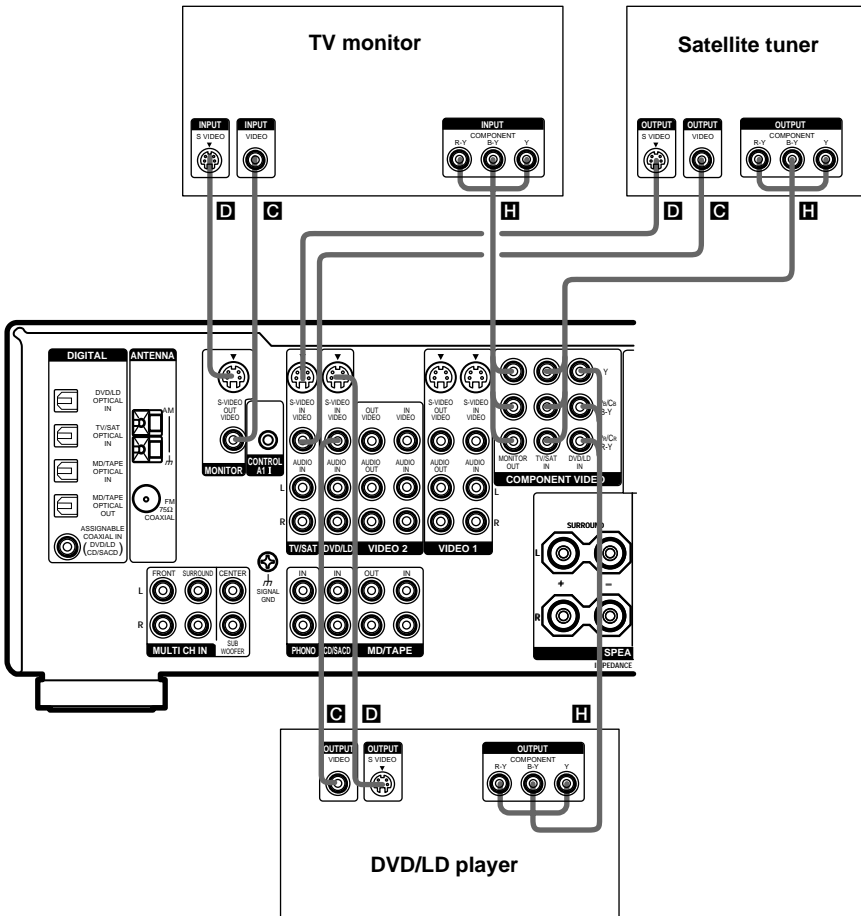

Tip

When the component is equipped with S-video jacks, you can connect the component to the S-VIDEO jacks on this receiver.

Note

You can listen to the sound of your TV by connecting your TV's audio output jacks to the TV/SAT AUDIO IN jacks on the receiver. In this case, do not connect the TV's video output jack to the TV/SAT VIDEO IN jack on the receiver. If you connect a separate satellite tuner, etc., connect both the audio and video output jacks to the receiver as shown above.

1a: Connecting components with digital audio output jacks (continued)

Hooking up a CD/Super Audio CD player and MD/Tape deck

For details on the required cords (**A–H**), see page 9.

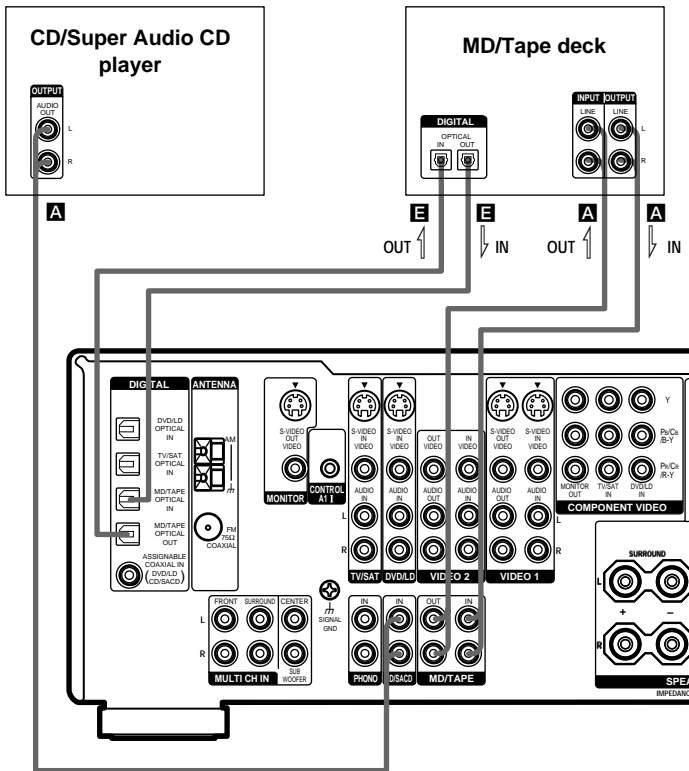

Tips

- All the digital audio jacks are compatible with 32 kHz, 44.1 kHz, 48 kHz and 96 kHz sampling frequencies.
- You can also connect an LD player with a DOLBY DIGITAL RF OUT jack via an RF demodulator (You cannot connect an LD player's DOLBY DIGITAL RF OUT jack directly to this unit's digital input jacks). Refer to the operating instructions supplied with the RF demodulator.

Notes

- No sound is output when playing a Super Audio CD disc on a Super Audio CD player connected to the ASSIGNABLE COAXIAL IN (DVD/LD CD/SACD) jack on this receiver. Connect the player to the analog input jacks (CD/SACD IN jacks). Refer to the operating instructions supplied with the Super Audio CD player.
- You cannot make digital recordings of digital multi channel surround signals.

1b: Connecting components with multi channel output jacks

1 Connect the audio jacks.

If your DVD/LD or CD/Super Audio CD player is equipped with multi channel decoder, you can connect it to this receiver's MULTI CH IN jacks to enjoy the sound of the connected component's multi channel decoder. Alternatively, the multi channel input jacks can be used to connect an external multi channel decoder.

For details on the required cords (**A–H**), see page 9.

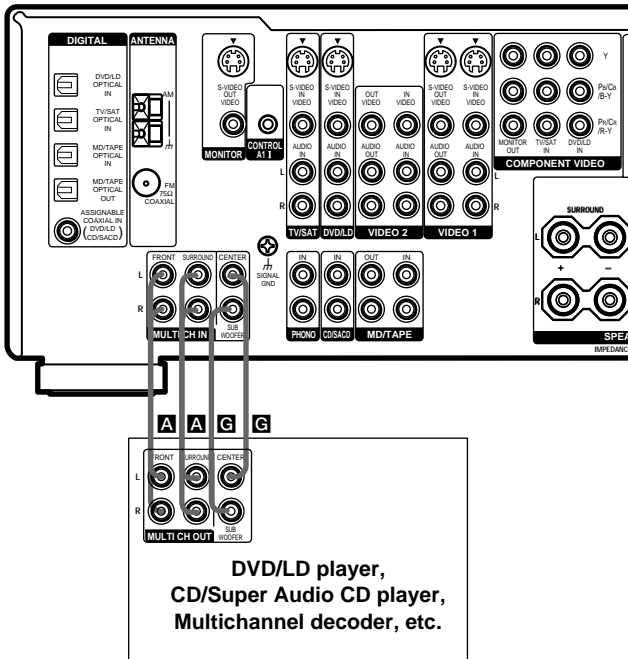

Tip

This connection also allows you to enjoy software with multi-channel audio recorded in formats other than the Dolby Digital, DTS and MPEG-2.

Note

When you make connections to the MULTI CH IN jacks, you will need to adjust the level of the surround speakers and sub woofer using the controls on the connected component.

continued

1b: Connecting components with multi channel output jacks (continued)

2 Connect the video jacks.

(Except for models of area code CEL, CEK)

The following illustration shows how to connect a DVD or LD player with COMPONENT VIDEO (Y, B-Y, R-Y) output jacks. Connecting a TV with component video input jacks allows you to enjoy high quality video.

Note

On this receiver, the component video signals cannot be converted to S-video or standard video signals (or vice versa).

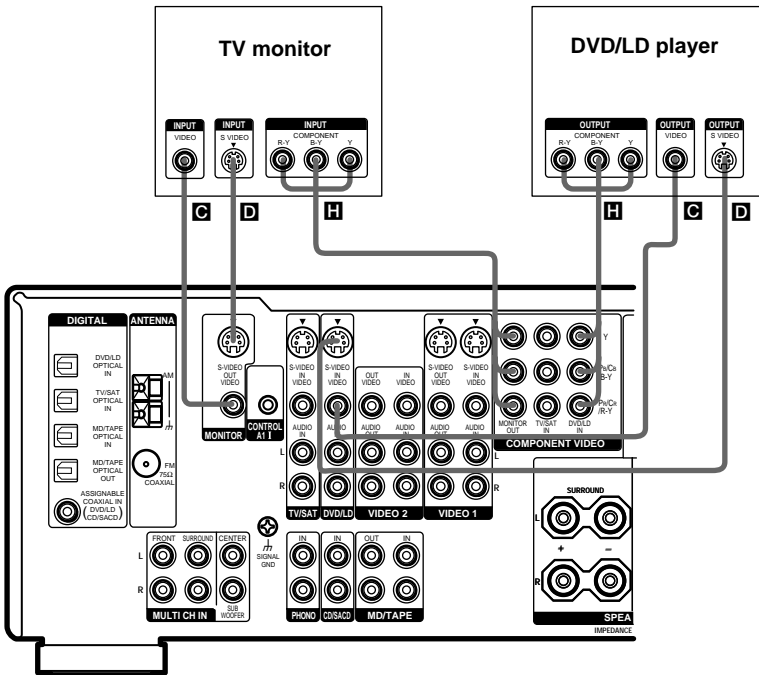

Tip

When the component is equipped with S-video jacks, you can connect the component to the S-VIDEO jacks on this receiver.

Note

You can listen to the sound of your TV by connecting your TV's audio output jacks to the TV/SAT AUDIO IN jacks on the receiver. In this case, do not connect the TV's video output jack to the TV/SAT VIDEO IN jack on the receiver. If you connect a separate satellite tuner, etc., connect both the audio and video output jacks to the receiver as shown above.

1c: Connecting components with only analog audio jacks

Hooking up audio components

For details on the required cords (**A-H**), see page 9.

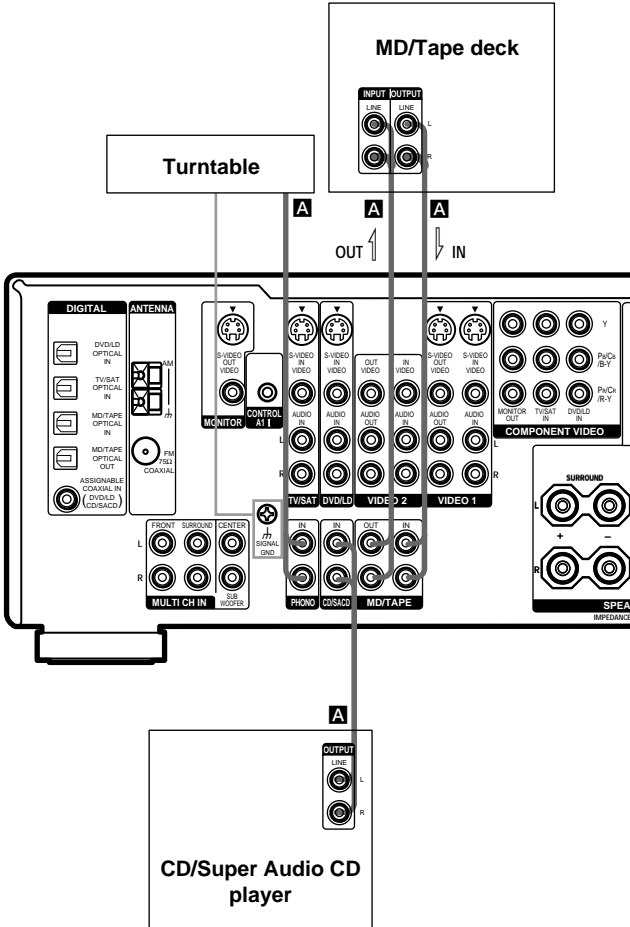

Note

If your turntable has a ground wire, connect it to the **h SIGNAL GND** terminal.

continued

1c: Connecting components with only analog audio jacks (continued)

Hooking up video components

If you connect your TV to the MONITOR jacks, you can watch the video from the selected input (function) (page 24).

For details on the required cords (**A–H**), see page 9.

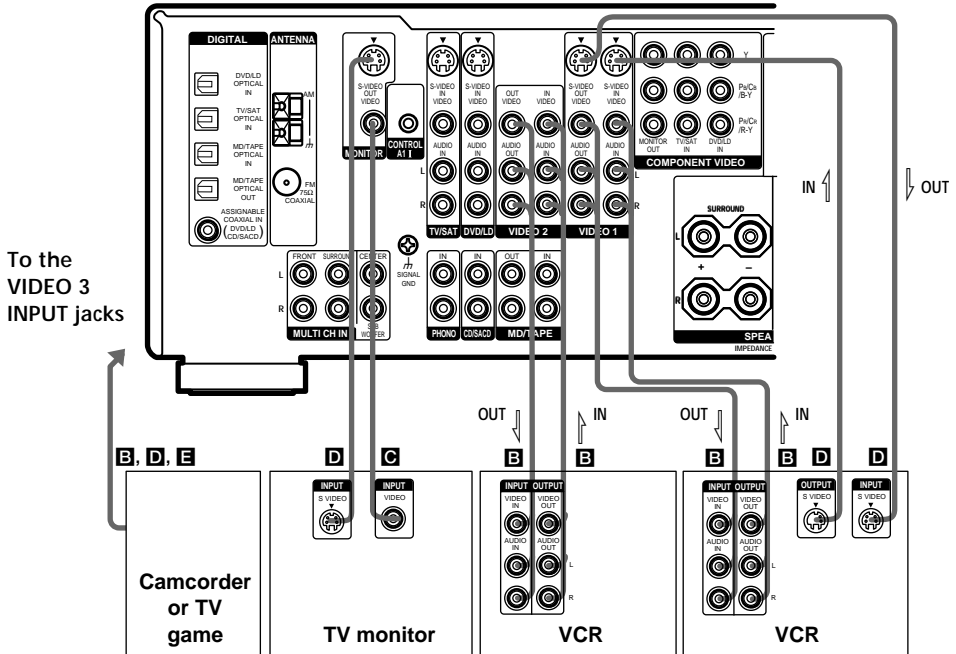

Tip

When the component is equipped with S-video jacks, you can connect the component to the S-VIDEO jacks on this receiver.

Note

You can listen to the sound of your TV by connecting your TV's audio output jacks to the TV/SAT AUDIO IN jacks on the receiver. In this case, do not connect the TV's video output jack to the TV/SAT VIDEO IN jack on the receiver. If you connect a separate satellite tuner, etc., connect both the audio and video output jacks to the receiver as shown above.

2: Connecting the antennas

Connect the supplied AM loop antenna and FM wire antenna.

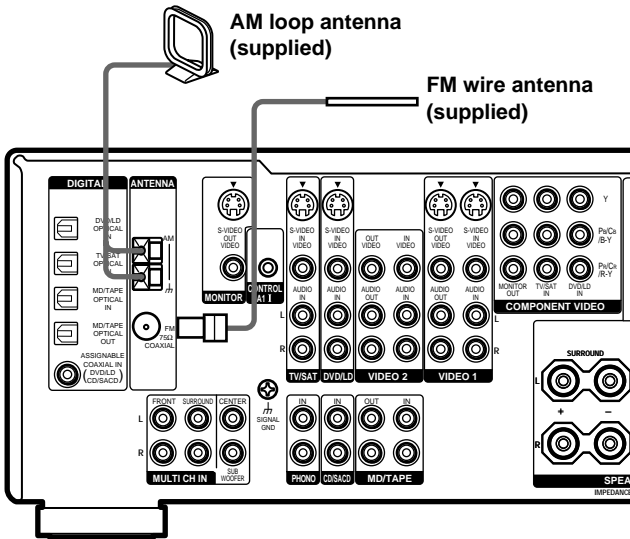

Notes

- To prevent noise pickup, keep the AM loop antenna away from the receiver and other components.
- Be sure to fully extend the FM wire antenna.
- After connecting the FM wire antenna, keep it as horizontal as possible.
- Do not use the \hbar SIGNAL GND terminal for grounding the receiver.

3: Connecting speakers

Connect your speakers to the receiver. This receiver allows you to use a 5.1 channel speaker system. To fully enjoy theater-like multi channel surround sound requires five speakers (two front speakers, a center speaker, and two surround speakers) and a sub woofer (5.1 channel).

Example of 5.1 channel speaker system configuration

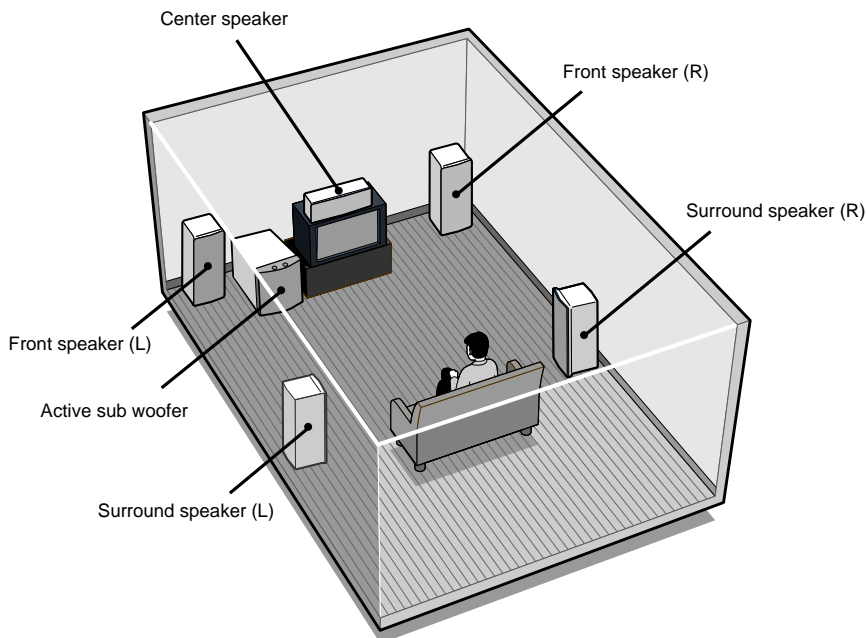

Tip

Since the active sub woofer does not emit highly directional signals, you can place it wherever you want.

Speaker impedance

To enjoy the best possible multi channel surround, connect speakers with a nominal impedance of 8 ohms or higher to the FRONT, CENTER, and SURROUND terminals, and set the IMPEDANCE SELECTOR to “8Ω”. Refer to the operating instructions supplied with your speakers if you are not sure of their impedance. (This information is often on the back of the speaker.)

Alternatively, you may connect speakers with nominal impedances between 4 and 8 ohms to any or all of the speaker terminals. However, be sure to set the IMPEDANCE SELECTOR to “4Ω” if you connect even one speaker with a nominal impedance between 4 and 8 ohms.

Note

Be sure to turn the power off before adjusting the IMPEDANCE SELECTOR.

Required cords

A Speaker cords (not supplied)



B Monaural audio cord (not supplied)

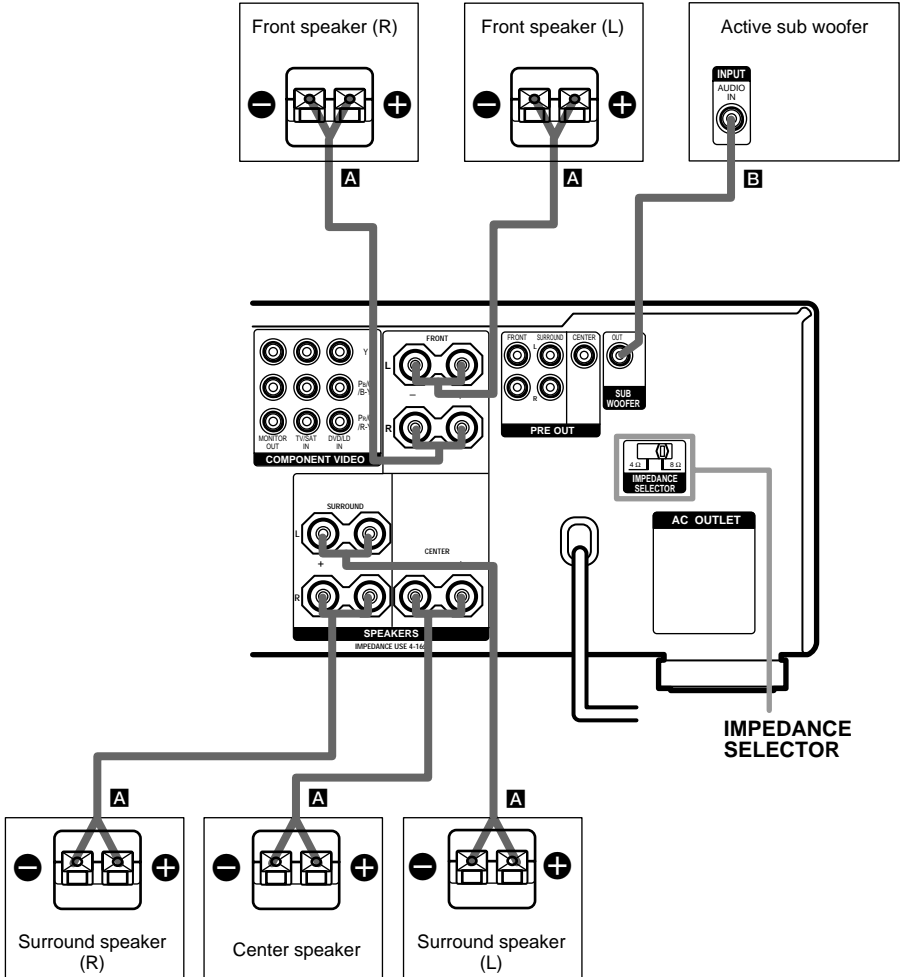

4: Connecting the AC power cord

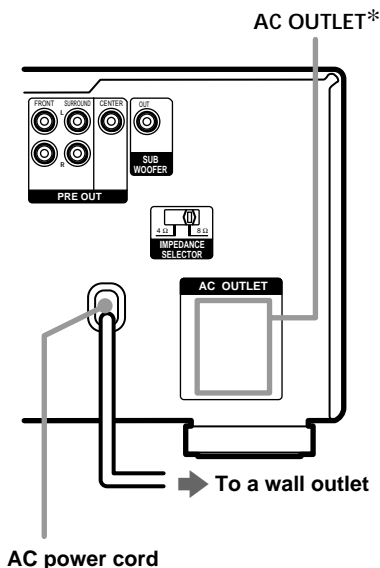

* Models of area code U, CA, SP, TW only.
The configuration, shape, and number of AC outlets vary according to the model and country to which the receiver is shipped.

Notes

- The AC OUTLET(s) on the rear of the receiver is a switched outlet, which supplies power to the connected component only while the receiver is turned on.
- Make sure that the total power consumption of the component(s) connected to the receiver's AC OUTLET(s) does not exceed the wattage stated on the rear panel. Do not connect high-wattage electrical home appliances such as electric irons, fans, or TVs to this outlet. This may cause a malfunction.

Performing initial setup operations

Before using the receiver for the first time, initialize the receiver by performing the following procedure.

This procedure can also be used to return settings you have made to their factory defaults.

1 Press I/⏻ to turn off the receiver.

2 Hold down I/⏻ for 5 seconds.

“INITIAL” appears in the display.

The following are reset to their factory settings.

- All settings in the SET UP, CUSTOMIZE, SURROUND, LEVEL, and EQ menus.
- The sound field memorized for each function and preset station.
- All preset stations.
- All index names for functions and preset stations.

5: Setting up the speakers

Use the SET UP menu to set the types and sizes of the speakers connected to the receiver.

1 Press I/⏻ to turn on the receiver.

2 Press SET UP.

3 Press the cursor buttons (< or >) to select the speaker.

For details, see “Speaker setup parameters” below.

Note

Some speaker settings may appear dimmed in the display. This means that they have been changed automatically due to other speaker settings. The dimmed settings may or may not be adjustable.

4 Turn the jog dial to select the parameter.

5 Repeat steps 3 and 4 until you have set all of the items that follow.

Speaker setup parameters

The initial setting is underlined.

■ FRONT (FRONT) (Front speaker size)

- LARGE

If you connect large speakers that will effectively reproduce bass frequencies, select “LARGE”. Normally, select “LARGE”.

- SMALL

If the sound is distorted, or you feel a lack of surround effects when using multi channel surround sound, select “SMALL” to activate the bass redirection circuitry and output the front channel bass frequencies from the sub woofer. When the front speakers are set to “SMALL”, the center, surround, and surround back speakers are also automatically set to “SMALL” (unless previously set to “NO”).

■ CENTER (CENTER) (Center speaker size)

- LARGE

If you connect a large speaker that will effectively reproduce bass frequencies, select “LARGE”. Normally, select “LARGE”. However, if the front speakers are set to “SMALL”, you cannot set the center speaker to “LARGE”.

- SMALL

If the sound is distorted, or you feel a lack of surround effects when using multi channel surround sound, select “SMALL” to activate the bass redirection circuitry and output the center channel bass frequencies from the front speakers (if set to “LARGE”) or sub woofer.

- NO

If you did not connect a center speaker, select “NO”. The sound of the center channel will be output from the front speakers.

continued

5: Setting up the speakers (continued)

■ SURROUND () (Surround speaker size)

- LARGE
If you connect large speakers that will effectively reproduce bass frequencies, select “LARGE”. Normally, select “LARGE”. However, if the front speakers are set to “SMALL”, you cannot set the surround speakers to “LARGE”.
- SMALL
If the sound is distorted, or you feel a lack of surround effects when using multi channel surround sound, select “SMALL” to activate the bass redirection circuitry and output the surround channel bass frequencies from the sub woofer or other “LARGE” speakers.
- NO
If you did not connect surround speakers, select “NO”.

Tip

The LARGE and SMALL settings for each speaker determine whether or not the internal sound processor will cut the bass signal from that channel. When the bass is cut from a channel, the bass redirection circuitry sends the corresponding bass frequencies to the sub woofer or other “LARGE” speakers.

However, since bass has a certain amount of directionality, it best not to cut them, if possible. Therefore, even when using small speakers, you can set them to “LARGE” if you want to output the bass frequencies from that speaker. On the other hand, if you are using a large speaker, but prefer not to have bass frequencies output from that speaker, set it to “SMALL”.

If the overall sound level is lower than you prefer, set all speakers to “LARGE”. If there is not enough bass, you can use the equalizer to boost the bass levels. To adjust the equalizer, see page 39.

■ SUB WOOFER () (Sub woofer selection)

- YES
If you connect a sub woofer, select “YES”.
- NO
If you did not connect a sub woofer, select “NO”. This activates the bass redirection circuitry and outputs the LFE signals from other speakers.

Tip

In order to take full advantage of the Dolby Digital bass redirection circuitry, we recommend setting the sub woofer’s cut off frequency as high as possible.

For advanced speaker setups

Use the CUSTOMIZE menu and set “MENU” to “MENU EXP.” This enables advanced setups including those of the distances to the speakers and heights of the speakers.

For details on “MENU”, see page 40. For details on how to set the items, see page 41.

6: Adjusting the speaker levels and balance

(TEST TONE)

Adjust the speaker levels and balance while listening the test tone from your listening position. Use the remote for the operation.

Tip

The receiver employs a test tone with a frequency centered at 800 Hz.

1 Press I/⏻ on the remote to turn on the receiver.

2 Press TEST TONE on the remote.

“T.TONE” appears in the display and the test tone is output from each speaker in sequence.

3 Adjust the speaker level and balance using the LEVEL menu so that the level of the test tone sounds the same from each speaker.

Tips

- To adjust the level of all speakers at the same time, press MASTER VOL +/- on the remote or turn MASTER VOLUME on the receiver.
- You can use the jog dial on the receiver only for the adjustment.

4 Press TEST TONE again after adjustment.

The test tone turns off.

Selecting the component

1 Rotate **FUNCTION** to select the function.

The selected function appears in the display.

To select the	Display
VCR	VIDEO 1 or VIDEO 2
Camcorder or TV game	VIDEO 3
DVD or LD player	DVD/LD
Satellite tuner	TV/SAT
MD or tape deck	MD/TAPE
CD or Super Audio CD player	CD/SACD
Built in tuner	TUNER
Turntable	PHONO

2 Turn on the component and start playback.

When you select a component which is also connected to the TV (such as VCR or DVD player), turn on the TV and set the TV's video input to match the component you selected.

If your TV is connected to the receiver's MONITOR jack, the video from the selected function will be displayed on the TV.

3 Rotate **MASTER VOLUME** to adjust the volume.

To mute the sound

Press **MUTING** on the remote.

To turn off the speaker system

Press **SPEAKERS ON/OFF** on the front panel.

Listening to multi channel sound

(MULTI CH DIRECT)

You can select the audio directly from the components connected to the MULTI CH IN jacks. This function enables you to enjoy high quality analog sources like DVD or Super Audio CD.

Surround effects are not activated when using this function.

Press **MULTI CH DIRECT** to select the multi channel audio source.

The selected audio source is output.

Note

This function is canceled when you switch the function (page 24), and press **MULTI CH DIRECT** again.

Listening to FM/AM radio

You can listen to FM and AM broadcasts through the built-in tuner. Before operation, make sure you have connected the FM and AM antennas to the receiver (see page 17).

Tip

The tuning scale for direct tuning differs depending on the area code as shown in the following table. For details on area codes, see page 3.

Area code	FM	AM
U, CA	100 kHz	10 kHz*
CEL, CEK, TW, KR, CN, SP	50 kHz	9 kHz

* The AM tuning scale can be changed (see page 61).

Automatic tuning

- 1 **Rotate FUNCTION to switch the function to TUNER.**
- 2 **Press FM/AM to select the FM or AM band.**
- 3 **Press TUNING + or – (TUNING/PTY SELECT + or – for models of area code CEL, CEK).**

Press + to scan from low to high; press – to scan from high to low.

The receiver stops scanning whenever a station is received.

In case of poor FM stereo reception
Press FM MODE to switch to monaural audio.
If the FM stereo reception is poor and “STEREO” flashes in the display, select the monaural audio so that the sound will be less distorted.

Direct tuning

Enter a frequency of the station directly by using the numeric buttons on the remote. For details on the supplied remote, refer to the operating instructions supplied with the remote.

- 1 **Press TUNER to switch the function to TUNER.**
You can also use the FUNCTION control on the receiver.
- 2 **Press FM/AM on the receiver repeatedly to select the FM or AM band.**
- 3 **Press D.TUNING.**
- 4 **Select the numbers for the frequency.**

Example 1: FM 102.50 MHz

① → ② → ⑤ → ① → ②

Example 2: AM 1,350 kHz

(You don't have to enter the last “0” when the tuning scale is set to 10 kHz.)

① → ③ → ⑤ → ①

If you've tuned in an AM station, adjust the direction of the AM loop antenna for optimum reception.

If you cannot tune in a station and the entered numbers flash
Make sure you've entered the right frequency.
If not, repeat steps 3 and 4. If the entered numbers still flash, the frequency is not used in your area.

Storing FM stations automatically (AUTOBETICAL)

(Models of area code CEL, CEK only)

This function lets you store up to 30 FM and FM RDS stations in alphabetical order without redundancy. Additionally, it only stores the stations with the clearest signals.

If you want to store FM or AM stations one by one, see “Presetting radio stations”.

1 Press I/⏻ to turn off the receiver.

2 Hold down MEMORY and press I/⏻ to turn the receiver back on.

“AUTO-BETICAL SELECT” scrolls in the display and the receiver scans and stores all the FM and FM RDS stations in the broadcast area.

For RDS stations, the tuner first checks for stations broadcasting the same program, then stores only the one with the clearest signal. The selected RDS stations are sorted alphabetically by their Program Service name, then assigned a 2-character preset code. For more details on RDS, see page 28.

Regular FM stations are assigned 2-character preset codes and stored after the RDS station.

When done, “FINISH” appears in the display momentarily and the receiver returns to the normal operation.

Notes

- Do not press any button on the receiver or supplied remote during autobetical operation, except I/⏻.
- If you move to another area, repeat this procedure to store stations in your new area.
- For details on tuning the stored stations, see page 27.
- If you move the antenna after storing stations with this procedure, the stored settings may no longer be valid. If this happens, repeat this procedure to store the stations again.

Presetting radio stations

You can preset up to 30 FM or AM stations. Then you can easily tune in the stations you often listen to.

Presetting radio stations

1 Rotate FUNCTION to switch the function to TUNER.

2 Tune in the station that you want to preset using Automatic Tuning (page 25) or Direct Tuning (page 25).

3 Press MEMORY.

“MEMORY” appears in the display for a few seconds. Do steps 4 to 5 before the display goes out.

4 Press PRESET TUNING + or – to select a preset number.

If “MEMORY” goes out before you select the preset number, start again from step 3.

5 Press MEMORY again.

The station is stored to the selected preset number.

If “MEMORY” goes out before you press MEMORY, start again from step 3.

6 Repeat steps 2 to 5 to preset another station.

Tuning to preset stations

- 1 Rotate FUNCTION to switch the function to TUNER.

The last received station is tuned in.

- 2 Press PRESET TUNING + or – repeatedly to select the preset station you want.

Each time you press the button, you can select the preset station as follows:

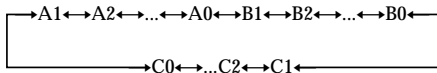

Using the remote

- 1 Press TUNER to switch the function to TUNER.
- 2 Press D.SKIP/CH/PRESET +/- repeatedly to select the preset station you want.

Using the Radio Data System (RDS)

(Models of area code CEL, CEK only)

This receiver also allows you to use RDS (Radio Data System), which enables radio stations to send additional information along with the regular program signal. You can use the following convenient RDS features:

- Displaying RDS information
- Scanning preset stations by program type

Note that RDS is operable only for FM stations.*

* Not all FM stations provide RDS service, nor do they provide the same types of services. If you are not familiar with the RDS services in your area, check with your local radio stations for details.

Receiving RDS broadcasts

Simply select a station on the FM band using direct tuning (page 25), automatic tuning (page 25), or preset tuning (page 27).

When you tune in a station that provides RDS services, the RDS indicator lights up and the program service name appears in the display.

Note

RDS may not work properly if the station you tuned to is not transmitting the RDS signal properly or if the signal strength is weak.

continued

Using the Radio Data System (RDS) (continued)

Displaying RDS information

While receiving an RDS station, press **DISPLAY**.

Each time you press the button, RDS information on the display changes cyclically as follows:

PS (Program Service name)^{a)} → Frequency^{a)}
→ PTY (Program TYpe) indication^{b)} →
RT (Radio Text) indication^{c)} → CT (Current
Time) indication (in 24-hour system) → Sound
field currently applied → Volume level

- a) This information also appears for non-RDS FM stations.
- b) Type of program being broadcast (see page 29).
- c) Text messages sent by the RDS station.

Notes

- If there is an emergency announcement by government authorities, “ALARM” flashes in the display.
- If a station does not provide a particular RDS service, “NO XX” (such as “NO CT”) appears in the display.
- When a station broadcasts radio text data, it is displayed at the same rate at which it is sent from the station. Any change in this rate is reflected in the display rate of the data.

Scanning preset stations by program type

You can tune in preset stations according to a program type that you specify. The receiver scans for stations in its preset memory currently broadcasting the specified program type.

1 Press **RDS PTY**.

2 Press **TUNING/PTY SELECT +** or **TUNING/PTY SELECT –** to select the program type.

See the table on the next page for the information on each program type.

3 Press **RDS PTY**.

While the receiver is scanning stations, “PTY” and “SEARCH” appears by turns in the display window.

When the receiver finds a station, the receiver stops scanning. When the receiver could not find any preset stations currently broadcasting the specified program type, “NO PTY” appears in the display.

Description of program types

Program type indication	Description
NEWS	News programs
AFFAIRS	Topical programs that expand on current news
INFO	Programs offering information on a wide spectrum of subjects, including consumer affairs and medical advice
SPORT	Sports programs
EDUCATE	Educational programs, such as "how-to" and advice programs
DRAMA	Radio plays and serials
CULTURE	Programs about national or regional culture, such as language and social concerns
SCIENCE	Programs about the natural sciences and technology
VARIED	Other types of programs such as celebrity interviews, panel games, and comedy
POP M	Popular music programs
ROCK M	Rock music programs
EASY M	Easy Listening
LIGHT M	Instrumental, vocal, and choral music
CLASSICS	Performances of major orchestras, chamber music, opera, etc.
OTHER M	Music that does not fit into any categories above, such as Rhythm & Blues and Reggae
WEATHER	Weather information
FINANCE	Stock market reports and trading, etc.
CHILDREN	Programs for children
SOCIAL	Programs about people and the things that affect them
RELIGION	Programs of religious content
PHONE IN	Programs where members of the public express their views by phone or in a public forum
TRAVEL	Programs about travel. Not for announcements that are located by TP/TA.

Program type indication	Description
LEISURE	Programs on recreational activities such as gardening, fishing, cooking, etc.
JAZZ	Jazz programs
COUNTRY	Country music programs
NATION M	Programs featuring the popular music of the country or region
OLDIES	Programs featuring oldies music
FOLK M	Folk music programs
DOCUMENT	Investigative features
NONE	Any programs not defined above

Changing the display

Changing the information in the display

You can check the volume, or sound field by changing the information in the display.

Press **DISPLAY** repeatedly.

The displayed information varies according to the selected function.

All functions except TUNER

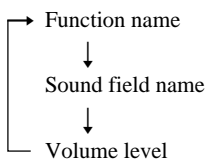

All functions except TUNER
(When the function name is indexed)
(page 47)

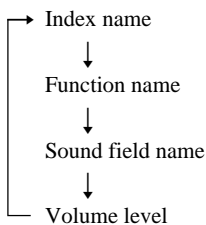

TUNER

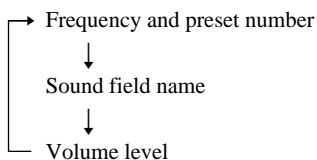

TUNER (When the preset name is indexed) (page 47)

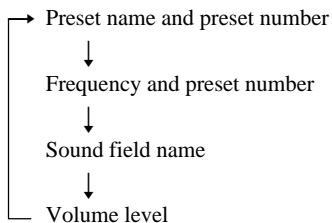

Changing the brightness of the display

Press **DIMMER** repeatedly.

The DIMMER button lights up and the brightness of the display changes in 3 steps.

About the indications in the display

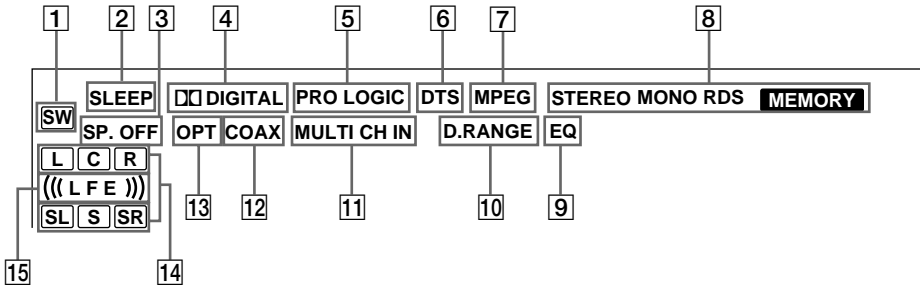

- 1 SW:** Lights up when sub woofer selection is set to “YES” and the receiver detects that the disc being played back does not contain the LFE channel signal. While this indicator lights up, the receiver creates a sub woofer signal based on the low frequency components of the front channels.
- 2 SLEEP:** Lights up when sleep timer is activated.
- 3 SP.OFF.:** Lights up when the headphones are inserted or the SPEAKERS ON/OFF is set to OFF.
- 4 DIGITAL:** Lights up when the receiver is decoding signals recorded in the Dolby Digital format.
- 5 PRO LOGIC:** Lights up when the receiver applies Pro Logic processing to 2 channel signals in order to output the center and surround channel signals. However, this indicator also lights when the Pro Logic II movie/music decoder is in active. However, this indicator does not light if the center and surround speakers are set to “NO”.
- 6 DTS:** Lights up when DTS signals are input. When playing a DTS format disc, be sure that you have made digital connections and that INPUT MODE is NOT set to ANALOG (see page 37).
- 7 MPEG:** Lights up when MPEG signals are input.
Note
Only the front 2 channels are compatible with MPEG format. Multi channel surround sound is downmixed and output from the front 2 channels.
- 8 Tuner indicators:** Light up when using the receiver to tune in radio stations, etc. See pages 25–29 for tuner operations.
- 9 EQ:** Lights up when the equalizer is functioning.
- 10 D.RANGE:** Lights up when dynamic range compression is activated. See page 46 to adjust the dynamic range compression.
- 11 MULTI CH IN:** Lights up when adjusting the level of the MULTI CH IN sub woofer channel.
- 12 COAX:** Lights up when the source signal is a digital signal being input through the COAXIAL terminal.
- 13 OPT:** Lights up when the source signal is a digital signal being input through the OPTICAL terminal.

continued

About the indications in the display (continued)

- 14 Playback channel indicators:** The letters (L, C, R, etc.) indicate the channels being played back. The boxes around the letters vary to show how the receiver downmixes the source sound (based on the speakers settings).

L (Front Left), R (Front Right), C (Center (monaural)), SL (Surround Left), SR (Surround Right), S (Surround (monaural or the surround components obtained by Pro Logic processing))

Example:

Recording format (Front/Surround): 3/2
Output channel: Surround speakers absent
Sound Field: AUTO DECODING.

SW

L C R

SL SR

- 15 L.F.E.:** Lights up when the disc being played back contains the LFE (Low Frequency Effect) channel. When the sound of the LFE channel signal is actually being reproduced, the bars underneath the letters lights up to indicate the level. Since the LFE signal is not recorded in all parts of the input signal the bar indication will fluctuate (and may turn off) during playback.

Automatically decoding the input audio signal

(AUTO DECODING)

In this mode, the receiver automatically detects the type of audio signal being input (Dolby Digital, DTS, standard 2 channel stereo, etc) and performs the proper decoding if necessary. This mode presents the sound as it was recorded/encoded, without adding any surround effects.

If you connect an active sub woofer
When the audio signal is 2 channel stereo or if the source signal does not include a LFE signal, the receiver generates a low frequency signal for output to the sub woofer.

Press AUTO DEC.

“AUTO DEC” appears in the display and the receiver switches to the AUTO DECODING mode.

Using only the front speakers

(2CH STEREO)

In this mode, the receiver outputs the sound from the front L/R speakers only. Standard 2 channel stereo sources completely bypass the sound field processing and multi channel surround formats are downmixed to 2 channel. There is no sound from the sub woofer.

Press 2CH ST.

“2CH ST.” appears in the display and the receiver switches to the 2CH STEREO mode.

Note

No sound is output from the sub woofer in the 2CH STEREO mode. To listen to the 2 channel stereo sources using the front L/R speakers and a sub woofer, set to the AUTO DECODING mode.

Selecting a sound field

You can take advantage of surround sound simply by selecting one of the receiver's pre-programmed sound fields. They bring the exciting and powerful sound of movie theaters and concert halls into your home.

Sound field	Display
Normal Surround	NORM.SURR.
Cinema Studio EX A	C.ST.EX A DCS
Cinema Studio EX B	C.ST.EX B DCS
Cinema Studio EX C	C.ST.EX C DCS
Hall	HALL
Jazz Club	JAZZ
Live Concert	CONCERT
Game	GAME

About DCS (Digital Cinema Sound) Sound fields with **DCS** marks use DCS technology.

DCS is the concept name of the surround technology for home theater developed by Sony. DCS uses the DSP (Digital Signal Processor) technology to reproduce the sound characteristics of an actual cinema cutting studio in Hollywood.

When played at home, DCS will create a powerful theater effect that mimics the artistic combination of sound and action as envisioned by the movie director.

Enjoying movies using the CINEMA STUDIO EX modes

CINEMA STUDIO EX modes are suitable for watching motion picture DVDs (etc.), with multi channel surround effects. You can reproduce the sound characteristics of Sony Pictures Entertainment's dubbing studio in your home.

Press CINEMA STUDIO EX A, B or C to select the CINEMA STUDIO EX mode you want.

The selected CINEMA STUDIO EX mode appears in the display.

■ C.ST.EX A (Cinema Studio EX A) **DCS**

Reproduces the sound characteristics of the Sony Pictures Entertainment "Cary Grant Theater" cinema production studio. This is a standard mode, great for watching most any type of movies.

■ C.ST.EX B (Cinema Studio EX B) **DCS**

Reproduces the sound characteristics of the Sony Pictures Entertainment "Kim Novak Theater" cinema production studio. This mode is ideal for watching science-fiction or action movies with lots of sound effects.

■ C.ST.EX C (Cinema Studio EX C) **DCS**

Reproduces the sound characteristics of the Sony Pictures Entertainment scoring stage. This mode is ideal for watching musicals or films where orchestra music is featured in the soundtrack.



About CINEMA STUDIO EX modes

The CINEMA STUDIO EX modes consist of the following three elements.

- **Virtual Multi Dimension**
Creates 5 sets of virtual speakers from a single pair of actual surround speakers.
- **Screen Depth Matching**
Creates the sensation that the sound is coming from inside the screen like in theaters.
- **Cinema Studio Reverberation**
Reproduces the type of reverberation found in theaters.

The CINEMA STUDIO EX modes integrate these three elements simultaneously.

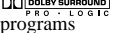
Tips

- You can also select the CINEMA STUDIO EX mode by pressing MODE +/- repeatedly.
- You can identify the encoding format of DVD software, etc. by looking at the logo on the package.
 - : Dolby Digital discs
 - : Dolby Surround encoded programs
 - : DTS Digital Surround encoded programs

Notes

- The effects provided by the virtual speakers may cause increased noise in the playback signal.
- When listening with sound fields that employ the virtual speakers, you will not be able to hear any sound coming directly from the surround speakers.
- Virtual speakers are always active in the CINEMA STUDIO EX modes.

Selecting other sound fields

Press MODE +/- repeatedly to select the sound field you want.

The selected sound field appears in the display.

■ **NORM.SURR. (Normal Surround)**

Software with multi channel surround audio signals is played back according to the way it was recorded. This sound field reproduces the acoustics of a small rectangular concert hall. For software with 2 channel audio signals, you can select from a variety of decoding modes according to the 2CH MODE setting.

■ **HALL (Hall)**

Reproduces the acoustics of a classical concert hall.

■ **JAZZ (Jazz Club)**

Reproduces the acoustics of a jazz club.

■ **CONCERT (Live Concert)**

Reproduces the acoustics of a 300-seat live house.

■ **GAME (Game)**

Obtains maximum audio impact from TV game software.

When the headphones are connected

Speaker output is automatically canceled and “SP. OFF” lights up in the display.

To turn off the surround effect

Press AUTO DEC or 2CH ST.

Enjoying Dolby Pro Logic II

(2CH MODE)

This function lets you specify the type of decoding for 2 channel audio sources.

This receiver can reproduce 2 channel sound in 5 channels through Dolby Pro Logic II; or 4 channels through Dolby Pro Logic.

Press NORMAL SURR (DOLBII) repeatedly to select the 2 channel decoding mode.

The selected mode appears in the display. The sound field automatically switches to “NORMAL SURROUND” (page 35).

2 channel decoding modes

- **PRO LOGIC (DOLBY PL)**
Performs Pro Logic decoding. The source recorded in 2 channel is decoded into 4.1 channels.
- **PLII MOVIE (II MOVIE)**
Performs Pro Logic II Movie mode decoding. This setting is ideal for movies encoded in Dolby Surround. In Addition, this mode can reproduce sound in 5.1 channel when watching videos of overdubbed or old movies.
- **PLII MUSIC (II MUSIC)**
Performs the Pro Logic II Music mode decoding. This setting is ideal for normal stereo sources such as CDs.

Tips

- When “PLII MUSIC” is selected, you can make further adjustments using “CENTER WIDTH”, “DIMENSION”, “PANORAMA” in the SURROUND menu.
- You can also select the 2 channel decoding mode using “2CH MODE” in the CUSTOMIZE menu (page 40).

Switching the audio input mode for digital components

(INPUT MODE)

You can switch the audio input mode for functions which have digital audio input jacks.

1 Rotate FUNCTION to select the function whose audio input mode you want to switch.

INPUT MODE is compatible with:
DVD/LD, TV/SAT, MD/TAPE, VIDEO 3, CD/SACD*.

(The INPUT MODE indicator lights up)

* When the ASSIGNABLE COAXIAL IN (DVD/LD CD/SACD) jack is assigned to CD/SACD function.

2 Press INPUT MODE repeatedly to select the audio input mode.

The selected audio input mode appears in the display.

Audio input modes

- AUTO IN
Gives priority to the analog audio signals input to the AUDIO IN (L/R) jacks when there is no digital audio signals.
- COAX IN
Specifies the digital audio signals input to the DIGITAL COAXIAL input jack.
- OPT IN
Specifies the digital audio signals input to the DIGITAL OPTICAL input jacks.
- ANALOG
Specifies the analog audio signals input to the AUDIO IN (L/R) jacks.

Customizing sound fields

By adjusting the SURROUND menu and LEVEL menu, you can customize the sound fields to suit your particular listening situation.

Note on the displayed items

The setup items you can adjust in each menu vary depending on the sound field. Certain setup parameters may be dimmed in the display. This means that the selected parameter is either unavailable or fixed and unchangeable.

Adjusting the SURROUND menu

You can customize the surround effects of the selected sound field. The settings are stored individually for each sound field.

1 Start playing a source encoded with multi channel surround effects (DVD, etc.).

2 Press SURR.

3 Press the cursor buttons (< or >) to select the parameter.

For details, see “SURROUND menu parameters” below.

4 While monitoring the sound, turn the jog dial to adjust the selected parameter.

5 Repeat steps 3 and 4 to adjust the other parameters.

SURROUND menu parameters

■ EFFECT X (Effect level)

Initial setting: 10

Higher settings apply more surround effect. You can adjust from 0 to 15 in 1 steps.

continued

Customizing sound fields (continued)

For advanced SURROUND menu adjustments

Use the CUSTOMIZE menu and set “MENU” to “MENU EXP.” to enable advanced adjustments.

For details on “MENU”, see page 40.

For details on how to set the items, see page 44.

Adjusting the LEVEL menu

You can adjust the balance and level of each speaker. These settings are applied to all sound fields.

- 1 Start playing a source encoded with multi channel surround effects (DVD, etc.).**
- 2 Press LEVEL.**
- 3 Press the cursor buttons (< or >) to select the parameter.**
For details, see “LEVEL menu parameters” below.
- 4 While monitoring the sound, turn the jog dial to adjust the selected parameter.**
- 5 Repeat steps 3 and 4 to adjust the other parameters.**

LEVEL menu parameters

■ BAL. *** (Front speaker balance)

Initial setting: 0 (BALANCE)

Lets you adjust the balance between front left and right speakers. You can adjust from -8 dB to +8 dB in 0.5 dB steps.

■ CTR XXX.X dB
(Center speaker level)

■ SUR.L. XXX.X dB
(Surround speaker (L) level)

■ SUR.R. XXX.X dB
(Surround speaker (R) level)

■ S.W. XXX.X dB
(Sub woofer level)

Initial setting: 0 dB

You can adjust from -20 dB to +10 dB in 0.5 dB steps.

■ S.W. XXX dB (MULTI CH IN)
(Multi channel sub woofer level)

Initial setting: +10 dB

Lets you increase the level of the MULTI CH IN sub woofer channel by +10 dB. This adjustment may be necessary when connecting a DVD player to the MULTI CH IN jacks. The sub woofer level from DVD players is 10 dB lower than Super Audio CD players.

Note

When one of the following sound fields are selected, no sound is output from the sub woofer if “FRONT” (front speaker size) in the SET UP menu is set to “LARGE”. However, the sound will be output from the sub woofer if the digital input signal contains LFE (Low Frequency Effect) signals.

- HALL
- JAZZ CLUB
- LIVE CONCERT

For advanced LEVEL menu adjustments

Use the CUSTOMIZE menu and set “MENU” to “MENU EXP.” to enable advanced adjustments.

For details on “MENU”, see page 40.

For details on how to set the items, see page 45.

Resetting sound fields to the initial settings

- 1 Press I/O to turn off the power.**
- 2 While holding down MODE +, press I/O.**
“S.F CLR.” appears in the display and all sound fields are reset to the initial settings.

Adjusting the equalizer

You can adjust the tonal quality (bass, treble level) of front speakers using the EQ menu.

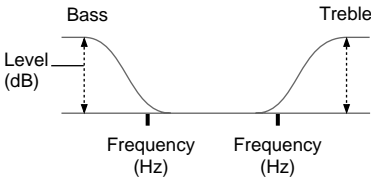

1 Start playing a source encoded with multi channel surround effects (DVD, etc.).

2 Press EQ.

3 Press the cursor buttons (< or >) to select the parameter.

For details, see “EQ menu parameters” below.

4 While monitoring the sound, turn the jog dial to adjust the selected parameter.

5 Repeat steps 3 and 4 to adjust the other items.

EQ menu parameters

■ BASS XXX.X dB
(Front speaker bass level)

■ TREB. XXX.X dB
(Front speaker treble level)

Initial setting: 0 dB

You can adjust from -10 dB to +10 dB in 0.5 dB steps.

To apply equalization

Press EQUALIZER. Each press turns the equalizer on or off. The EQ indicator lights when the equalizer is on.

For advanced EQ menu adjustments

Use the CUSTOMIZE menu and set “MENU” to “MENU EXP.” to enable advanced adjustments.

For details on “MENU”, see page 40.

For details on how to set the items, see page 46.

Advanced settings

Using the CUSTOMIZE menu to adjust the receiver

You can adjust various receiver settings using the CUSTOMIZE menu.

- 1 Press CUSTOMIZE.**
- 2 Press the cursor buttons (< or >) to select the parameter.**
For details, see “CUSTOMIZE menu parameters” below.
- 3 Turn the jog dial to adjust the selected parameter.**
- 4 Repeat steps 2 and 3 to adjust the other items.**

CUSTOMIZE menu parameters

The initial setting is underlined.

■ MENU

(Menu expanding)

• MENU EXP.

The advanced parameters for the SET UP, SURROUND, LEVEL, and EQ menus are displayed and can be adjusted.

For details on each setup items, see pages 21, 37–39 and the following pages.

• MENU STD

The advanced parameters are not displayed.

■ 2CH MODE

(2 channel decoding mode)

You can use the CUSTOMIZE menu to set the 2 channel decoding mode (page 36).

You can set this parameter only when NORMAL SURROUND or AUTO DECODING* is selected. In the Cinema Studio EX mode, this parameter is always set to “PRO LOGIC” and cannot be changed.

For details on each decoding mode, see page 36.

* The selected decoding mode is applied only when the Dolby Digital [Lt/Rt] signal is input.

• DOLBY PL

• II MOVIE

• II MUSIC

■ S.F.

(Sound field link)

• S.F. LINK

Lets you apply the last selected sound field to a function whenever it is selected. For example, if you select HALL for CD/SACD function, change to a different function and return to CD/SACD function, HALL is automatically applied again.

• S.F. FIX

Sound field link is not activated.

■ DEC.

(Digital audio input decoding mode)

Lets you specify the input mode for the digital signal input to the DIGITAL IN jacks.

• DEC. AUTO

Automatically switches the input mode between DTS, Dolby Digital, PCM, or MPEG2.

• DEC. PCM

Decodes all the input signals as PCM signals. If a Dolby Digital, DTS*, or MPEG (etc.) signal is input, no sound is output. When set to “AUTO”, and the sound from the digital audio jacks (for CD, etc.) is interrupted when playback starts, set to “PCM”.

* Playback of DTS-CD software will output noise.

■ PWR.S.

(Control A1: Power link)

• PWR.S.–ON

The power link function is not activated, but you can decrease the power consumption of the receiver during standby mode.

• PWR.S.–OFF

Lets you turn on the receiver automatically when the component connected via CONTROL A1 cords (page 49) is turned on.

■ A.FUN.

(Control A1: Function link)

• A.FUN.–ON

Lets you switch the function of this receiver to the Sony components connected via CONTROL A1 cords (page 49) automatically when the playback on the component is started.

• A.FUN.–OFF

Function link is not activated.

■ **C.MODE.**
(Command mode)

Lets you select the command mode of the remote. If the command mode of the receiver and the remote is different, operation from the remote is not possible.

- C.MODE.AV1
- C.MODE.AV2

The remote supplied for models of area code CEL, CEK can only operate the receiver when it is set to the AV1 mode. If you would like to do operate the receiver in AV2 mode, we recommend that you purchase an optional Sony remote.

■ **COAX** (Coaxial assignment)

Lets you assign the ASSIGNABLE COAXIAL IN (DVD/LD CD/SACD) to either the DVD/LD function or the CD/SACD function. For details, see “Switching the audio input mode for digital components” on page 37.

- COAX-DVD
- COAX-CD

■ **NAME IN**
(Naming preset stations and functions)

For details, see “Naming preset stations and functions” on page 47.

Advanced SET UP menu parameters

When “MENU” is set to “MENU EXP.”, all of the following parameters are displayed and adjustable.

See page 21 for the SET UP menu adjustments.

Initial settings are underlined.

All SET UP menu parameters

FRONT (FRONT)

CENTER (CENTER)

SURROUND (SURROUND)

SUB WOOFER (SUB WOOFER)

DIST XX.X m (ft.)*1 *2

DIST XX.X m (ft.)*1 *2

DIST XX.X m (ft.)*1 *2

DIST XX.X m (ft.)*1 *2

DISTANCE*1 *2

PL. XXX*1

HGT. XXX*1

FRT > XXX Hz*1

CTR > XXX Hz*1

SUR. > XXX Hz*1

L.F.E. > XXX Hz*1.

*1 Adjustable only when “MENU” is set to “MENU EXP.”.

*2 Default unit is “ft.” (feet) for models of area code U, CA.
Default unit is “m” (meter) for models of other area codes.

continued

Advanced settings (continued)

■ FRONT XX.X meter (FRONT) (Front speaker distance)

Initial setting: 5.0 m (16 ft.)

Lets you set the distance from your listening position to the front speakers (A). You can adjust from 1.0 meter to 12.0 meters (3 to 40 feet) in 0.1 meter (1 foot) steps.

If both front speakers are not placed an equal distance from your listening position, set the distance to the closest speaker.

When placing surround speakers to your side (long room)

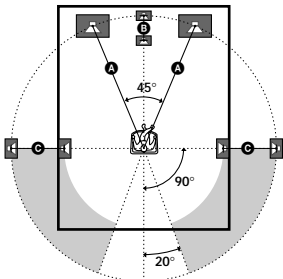

When placing surround speakers behind you (wide room)

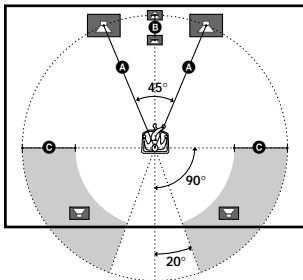

■ CENTER XX.X meter (CENTER) (Center speaker distance)

Initial setting: 5.0 m (16 ft.)

Lets you set the distance from your listening position to the center speaker. You can adjust from a distance equal to the front speaker distance (A) to a distance 1.5 meters (5 feet) closer to your listening position (B) in 0.1 meter (1 foot) steps.

When this range is exceeded, the display blinks. If you select a setting while the display is blinking, you will not be able to enjoy full surround effects.

■ SURROUND XX.X meter (SURROUND) (Surround speaker distance)

Initial setting: 5.0 m (16 ft.)

Lets you set the distance from your listening position to the surround speakers. You can adjust from a distance equal to the front speaker distance (A) to a distance 4.5 meters (15 feet) closer to your listening position (B) in 0.1 meter (1 foot) steps.

When this range is exceeded, the display blinks. If you select a setting while the display is blinking, you will not be able to enjoy full surround effects.

If both surround speakers are not placed an equal distance from your listening position, set the distance to the closest speaker.

■ SUB WOOFER XX.X meter (SUBWOOFER) (Sub woofer distance)

Initial setting: 5.0 m (16 ft.)

Lets you set the distance from your listening position to the sub woofer. You can adjust from 1.0 meter to 12.0 meters (3 to 40 feet) in 0.1 meter (1 foot) steps.

Tip

The receiver lets you to input the speaker position in terms of distance. However, it is not possible to set the center speaker further than the front speakers.

Also, the center speaker cannot be set more that 1.5 meters (5 feet) closer than the front speakers. Likewise, the surround speakers can not be set farther away from the listening position than the front speakers. And they can be no more than 4.5 meters (15 feet) closer.

This is because incorrect speaker placement is not conducive to the enjoyment of surround sound.

Please note that, setting the speaker distance closer than the actual location of the speakers will cause a delay in the output of the sound from that speaker. In other words, the speaker will sound like it is farther away.

For example, setting the center speaker distance 1–2 meters (3–6 feet) closer than the actual speaker position will create a fairly realistic sensation of being “inside” the screen. If you cannot obtain a satisfactory surround effect because the surround speakers are too close, setting the surround speaker distance closer (shorter) than the actual distance will create a larger sound stage.

Adjusting these parameter while listening to the sound often results in much better surround sound. Give it a try!

■ DISTANCE (Distance unit)

Lets you select the unit of measure for setting distances.

- feet (default for models for area code U, CA)
The distance is displayed in feet. "ft." indicator lights up.
- meter (default for models for other area codes)
The distance is displayed in meters. "m" indicator lights up.

■ SURROUND PL. () (Surround speaker position)*

Lets you specify the location of your surround speakers for proper implementation of the surround effects in the Cinema Studio EX modes (page 34).

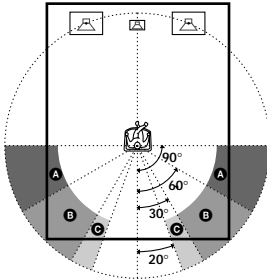

- SIDE
Select if the location of your surround speakers corresponds to section **A**.
- MID
Select if the location of your surround speakers corresponds to section **B**.
- BEHD.
Select if the location of your surround speakers corresponds to section **C**.

Tip

“SURROUND PL.” (Surround speaker position) is designed specifically for implementation of the sound fields of the Cinema Studio EX modes.

For other sound fields, speaker position is not so critical. Those sound fields were designed under the premise that the surround speakers would be located behind the listening position, but presentation remains fairly consistent even with the surround speakers positioned at a rather wide angle. However, if the speakers are pointing toward the listener from the immediate left and right of the listening position, the SURROUND effects becomes unclear unless set to “SIDE”.

Nevertheless, each listening environment has many variables, like wall reflections, and you may obtain better results using “BEHD.” or “MID” if your speakers are located high above the listening position, even if they are to the immediate left and right.

Therefore, although it may result in a setting contrary to the above explanation, we recommend that you playback multi channel surround encoded software and select the setting that provides a good sense of spaciousness and that best succeeds in forming a cohesive space between the surround sound from the surround speakers and the sound of the front speakers. If you are not sure which sounds best, select “BEHD.” and then use the speaker distance parameter and speaker level adjustments to obtain proper balance.

continued

Advanced settings (continued)

■ SURROUND HGT. ()*

(Surround speaker height)*

Lets you specify the height of your surround speakers for proper implementation of the surround effects of the Cinema Studio EX modes (page 34).

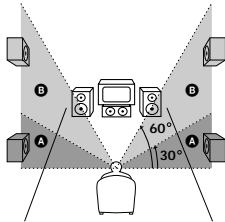

• LOW

Select if the height of your surround speakers corresponds to section **A**.

• HIGH

Select if the height of your surround speakers corresponds to section **B**.

* This setup item is not available when “SURROUND” (surround speaker size) is set to “NO”.

■ FRT > XXX Hz (Front speaker crossover frequency)

Initial setting: STD (120 Hz)

Lets you adjust the front speaker bass crossover frequency when “FRONT” (front speaker size) is set to “SMALL”. You can adjust from 40 Hz to 200 Hz in 10 Hz steps.

■ CTR > XXX Hz (Center speaker crossover frequency)

Initial setting: STD (120 Hz)

Lets you adjust the center speaker bass crossover frequency when “CENTER” (center speaker size) is set to “SMALL”. You can adjust from 40 Hz to 200 Hz in 10 Hz steps.

■ SUR. > XXX Hz (Surround speaker crossover frequency)

Initial setting: STD (120 Hz)

Lets you adjust the surround speaker bass crossover frequency when “SURROUND” (surround speaker size) is set to “SMALL”. You can adjust from 40 Hz to 200 Hz in 10 Hz steps.

■ L.F.E. > XXX Hz (LFE high cut filter)

Initial setting: STD (120 Hz)

Lets you select the cut off frequency of the LFE channel high cut filter. Normally, select “STD (120 Hz)”.

When using a passive sub woofer powered by a separate power amplifier, it may be better to change the cut off frequency. In this case, you can adjust from 40 Hz to 200 Hz in 10 Hz steps.

Advanced SURROUND menu parameters

When “MENU” is set to “MENU EXP.”, all of the following parameters are displayed and adjustable.

See page 37 for the SURROUND menu adjustments.

Initial settings are underlined.

All SURROUND menu parameters

C.WIDTH X*

DIMEN. X*

PANO.*

EFFECT XX

WALL XXX*

REVB. XXX*

SCR.*

* Adjustable only when “MENU” is set to “MENU EXP.”.

■ C WIDTH X (Center width control)

Initial setting: 3

Lets you perform further adjustments for Dolby Pro Logic II Music mode decoding (PLII MUSIC). You can set this parameter only when “2CH MODE” is set to “PLII MUSIC” (page 36) and NORMAL SURROUND is selected.

You can adjust the distribution of the center channel signal, generated through the Dolby Pro Logic II decoding, to the L/R speakers. C WIDTH is adjustable in 8 steps from “0” (no spread) to “7” (full phantom).

■ **DIMEN. X**
(Dimension control)

Initial setting: 3

Lets you perform further adjustments for Dolby Pro Logic II Music mode decoding (PLII MUSIC). You can set this parameter only when "2CH MODE" is set to "PLII MUSIC" (page 36) and NORMAL SURROUND is selected.

You can adjust the difference between the front channels and the surround channels. DIMENSION is adjustable in 7 steps from "0" (front) to "6" (surround).

■ **PANO.**
(Panorama mode)

Lets you perform further adjustments for Dolby Pro Logic II Music mode decoding (PLII MUSIC). You can set this parameter only when "2CH MODE" is set to "PLII MUSIC" (page 36) and NORMAL SURROUND is selected.

- **ON**
Lets you enjoy the surround sound by spreading the sound field of front speakers to the left and right of the listening position (panorama mode).
- **OFF**
Panorama mode is not activated.

■ **WALL XXX** (Wall type)

Initial setting: MID (0)

When sound is reflected off soft material, such as a curtain, the high frequency elements are reduced. A hard wall is highly reflective and does not significantly effect the frequency response of the reflected sound.

"WALL" lets you control the level of the high frequencies to alter the sonic character of your listening environment by simulating a softer (S) or harder (H) wall. You can adjust from S to H in 17 steps. MID (0) setting designates a neutral wall made of wood.

■ **REVB. XXX** (Reverberation)

Initial setting: MID (0)

Before sound reaches our ears, it is reflected (reverberated) many times between the left and right walls, ceiling, and floor. In a large room, sound takes more time to bounce from one surface to another than in a smaller room.

"REVERB" lets you control the spacing of the early reflections to simulate a sonically longer (L) or shorter (S) room. You can adjust from S to L in 17 steps. MID (0) designates a standard room with no adjustment.

■ **SCR.** (Screen depth)

Lets you create the sensation that the sound of the front speakers comes from inside the screen in your listening room, like theaters.

- **OFF**
This function is not activated.
- **MID**
Normally, select "MID".
- **DEEP**
Lets you create the sensation that the sound comes from a very large screen with a great amount of screen depth.

Advanced LEVEL menu parameters

When "MENU" is set to "MENU EXP.," all of the following parameters are displayed and adjustable.

See page 38 for the LEVEL menu adjustments.

Initial settings are underlined.

All LEVEL menu parameters

<u>FRONT</u>
CTR XXX.X dB
SUR.L. XXX.X dB
SUR.R. XXX.X dB
S.W. XXX.X dB
MULTI CH IN S.W. XXX dB
L.F.E. XXX.X dB*
D.RANGE COMP.*

* Adjustable only when "MENU" is set to "MENU EXP."

continued

Advanced settings (continued)

■ L.F.E. XXX.X dB

(LFE (Low Frequency Effect) mix level)

Initial setting: 0 dB

Lets you attenuate the level of the LFE (Low Frequency Effect) channel output from the sub woofer without effecting the level of the bass frequencies sent to the sub woofer from the front, center or surround channels via the Dolby Digital or DTS bass redirection circuitry. You can adjust from -20 dB to 0 dB (line level) in 0.5 dB steps. "0 dB" outputs the full LFE signal at the mix level determined by the recording engineer. When set to "OFF", the sound of the LFE channel from the sub woofer is muted. In this case, the low frequency sounds of the front, center, or surround speakers are output from the sub woofer according to the settings made for each speaker (pages 21–22).

■ COMP. (DYNAMIC RANGE)

(Dynamic range compressor)

Lets you compress the dynamic range of the sound track. This may be useful when you want to watch movies at low volumes late at night.

• OFF

The dynamic range is not compressed.

• 0.1–0.9

The dynamic range is compressed in small steps to achieve the sound you desire.

• STD

The dynamic range is compressed as intended by the recording engineer.

• MAX

The dynamic range is compressed dramatically.

Tip

Dynamic range compressor lets you to compress the dynamic range of the soundtrack based on the dynamic range information included in the Dolby Digital signal. "STD" is standard compression, but because many sources have only light compression, you may not notice much difference when using 0.1–0.9.

Therefore, we recommend using the "MAX" setting. This greatly compresses the dynamic range and lets you view movies late at night at low volumes. Unlike analog limiters, the levels are predetermined and provide a very natural compression.

Note

Dynamic range compression is possible with Dolby Digital sources only.

Advanced EQ menu parameters (front speakers only)

When "MENU" is set to "MENU EXP.", all of the following parameters are displayed and adjustable.

See page 39 for the EQ menu adjustments.

All EQ menu parameters

BASS XXX.X dB

BASS XXX Hz*

TREB. XXX.X dB

TREB. XXX Hz*

* Adjustable only when "MENU" is set to "MENU EXP."

■ BASS XXX.X Hz

(Front speaker bass frequency)

Initial setting: 250 Hz

You can adjust from 99 Hz to 1.0 kHz in 21 steps.

■ TREB. XXX.X Hz

(Front speaker treble frequency)

Initial setting: 2.5 kHz

You can adjust from 1.0 kHz to 10 kHz in 23 steps.

Naming preset stations and functions

You can enter a name of up to 8 characters for preset stations and functions and display it in the receiver's display.

- 1 To index a preset station
Rotate FUNCTION to select TUNER, then tune in the preset station you want to create an index name for (page 27).

To index a function

Rotate FUNCTION to select a function you want to create an index name for.

- 2 Press **CUSTOMIZE**.

- 3 Press the cursor button (>) to select **"NAME IN"**.

- 4 Press **ENTER**.

The cursor flashes and you can select a character.

- 5 **Create an index name by using the jog dial and cursor buttons (< or >).**

Turn the jog dial to select a character, then press the cursor button (>) to move the cursor to the next position.

Tips

- You can select the character type as follows by turning the jog dial.
Alphabet (upper case) → Numbers → Symbols
- To enter a blank space, turn the jog dial until a blank space appears in the display.
- If you made a mistake, press the cursor button (< or >) until the character you want to change flashes, then turn the jog dial to select the correct character.

- 6 Press **ENTER**.

The entered name is registered.

- 7 **To create index names for other preset stations and functions, repeat steps 1 to 6.**

Note

(Models of area code CEL, CEK only)

When you name an RDS station and tune in the station, the Program Service (PS) name appears instead of the name you entered. (You cannot change the name of a Program Service (PS) name. The name you entered will be overwritten by the Program Service (PS) name.)

Using the Sleep Timer

You can set the receiver to turn off automatically at a specified time by using the remote.

For details, refer to the operating instructions supplied with the remote.

Press SLEEP on the remote repeatedly while the power is on.

Each time you select SLEEP, the display changes cyclically as follows:

2:00:00 → 1:30:00 → 1:00:00 → 0:30:00 → OFF

While using Sleep Timer, "SLEEP" lights up in the display.

Tips

- For models of area code U, CA, you can also use the SLEEP button on the receiver.
- To check the remaining time before the receiver turns off, press SLEEP. The remaining time appears in the display.

Recording

Before you begin, make sure you've connected all components properly.

Recording on an audio tape or MiniDisc

You can record on a MiniDisc or cassette tape using the receiver. See the operating instructions of your cassette deck or MD deck if you need help.

- 1 Select the component to be recorded.**
- 2 Prepare the component for playing.**
For example, insert a CD into the CD player.
- 3 Insert a blank tape or MD into the recording deck and adjust the recording level, if necessary.**
- 4 Start recording on the recording deck, then start playback on the playback component.**

Notes

- You cannot record a digital audio signal using a component connected to the analog MD/TAPE OUT jacks. To record a digital audio signal, connect a digital component to the DIGITAL MD/TAPE OUT jacks.
- Sound adjustments do not affect the signal output from the MD/TAPE OUT jacks.
- The analog audio signals of the current function is output from the REC OUT jacks.
- The signals input to the MULTI CH IN jacks are not output from the REC OUT jacks even when MULTI CH DIRECT is selected. The analog audio signals of the current function are output.
- No signal is output from DIGITAL OUT jack (MD/TAPE OPTICAL OUT) when INPUT MODE is ANALOG even if digital audio signal is input to DIGITAL IN jack.

Recording on a video tape

You can record from a VCR, a TV, or an LD player using the receiver. You can also add audio from a variety of audio sources when editing a video tape. See the operating instructions of your VCR or LD player if you need help.

- 1 Select the program source to be recorded.**
- 2 Prepare the component for playing.**
For example, insert the laser disc you want to record into the LD player.
- 3 Insert a blank video tape into the VCR (VIDEO 1 or VIDEO 2) for recording.**
- 4 Start recording on the recording VCR, then start playing the video tape or laser disc you want to record.**

Tip

You can record the sound from any audio source onto a video tape while copying from a video tape or laser disc. Locate the point where you want to start recording from another audio source, select the program source, then start playback. The audio from that source will be recorded onto the audio track of the video tape instead of the audio from the original medium. To resume audio recording from the original medium, select the video source again.

Notes

- Make sure to make both digital and analog connections to the TV/SAT and DVD/LD inputs. Analog recording is not possible if you make only digital connections.
- Some sources contain copy guards to prevent recording. In this case, you may not be able to record from the sources.
- The analog audio signals of the current function is output from the REC OUT jacks.
- The signals input to the MULTI CH IN jacks are not output from the REC OUT jacks even when MULTI CH DIRECT is selected. The analog audio signals of the current function are output.

CONTROL A1II control system

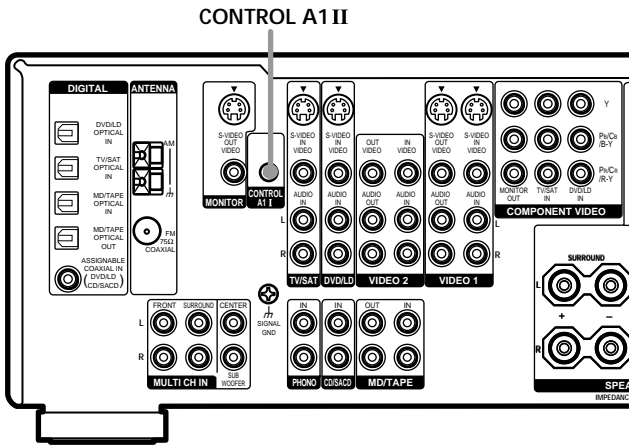

Using the CONTROL A1 II system

Getting Started

This section explains the basic functions of the CONTROL A1 II Control System. Certain components have special functions, like “CD Synchro Dubbing” on cassette decks, that require CONTROL A1 II connections. For detailed information regarding specific operations, be sure to also refer to the Operating Instructions supplied with your component(s).

The CONTROL A1 II Control System was designed to simplify the operation of audio systems composed of separate Sony components. CONTROL A1 II connections provide a path for the transmission of control signals which enable automatic operation and control features usually associated with integrated systems.

Currently, CONTROL A1 II connections between a Sony CD player, amplifier (receiver), MD deck and cassette deck provide automatic function selection and synchronized recording.

In the future, the CONTROL A1 II connection will work as a multifunction bus allowing you to control various functions for each component.

Notes

- The CONTROL A1 II Control System is designed to maintain upward compatibility as the Control System is upgraded to handle new functions. In this case, however, older components will not be compatible with the new functions.
- Do not operate a 2 way remote control unit when the CONTROL A1 II jacks are connected via a PC interface kit to a personal computer running “MD Editor” or similar application. Also, do not operate the connected component in a manner contrary to the functions of the application, as this may cause the application to operate incorrectly.

continued

CONTROL A1II control system (continued)

CONTROL A1II and CONTROL A1 compatibility

The CONTROL A1 control system has been updated to the CONTROL A1II which is the standard system in the Sony 300 disc CD changer and other recent Sony components. Components with CONTROL A1 jacks are compatible with components with CONTROL A1II, and can be connected to each other. Basically, the majority of the functions available with the CONTROL A1 control system will be available with the CONTROL A1II control system.

However, when making connections between components with CONTROL A1 jacks and components with CONTROL A1II jacks, the number of functions that can be controlled may be limited depending on the component. For detailed information, refer to the operating instructions supplied with the component(s).

CONTROL A1II hookup

- **If you have a CONTROL A1II compatible Sony CD player, Super Audio CD player, tape deck, or MD deck**

Use a CONTROL A1 cord (mini jack) (not supplied) to connect the CONTROL A1II jack on the CD player, Super Audio CD player, tape deck, or MD deck to the CONTROL A1II jack on the receiver. See page 49 and the operating instructions supplied with your CD player, Super Audio CD player, tape deck, or MD deck for details.

Note

If you make CONTROL A1II connections from the receiver to an MD deck that is also connected to a computer, do not operate the receiver while using the “Sony MD Editor” software. This may cause a malfunction.

- **If you have a Sony CD changer with a COMMAND MODE selector**

If your CD changer’s COMMAND MODE selector can be set to CD 1, CD 2, or CD 3, be sure to set the command mode to “CD 1” and connect the changer to the CD jacks on the receiver.

If, however, you have a Sony CD changer with VIDEO OUT jacks, set the command mode to “CD 2” and connect the changer to the VIDEO 2 jacks on the receiver.

Connections

Connect monaural (2P) mini-plug cords in series to the CONTROL A1II jacks on the back of each component. You can connect up to 10 CONTROL A1II compatible components in any order. However, you can connect only one of each type of component (i.e., 1 CD player, 1 MD deck, 1 tape deck and 1 receiver). (You may be able to connect more than one CD player or MD deck, depending on the model. Refer to the operating instructions supplied with the respective component for details.)

Example

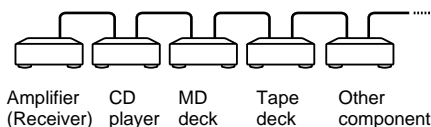

In the CONTROL A1II control system, the control signals flow both ways, so there is no distinction of IN and OUT jacks. If a component has more than one CONTROL A1II jack, you can use either one, or connect different components to each jack.

Jacks and connection examples

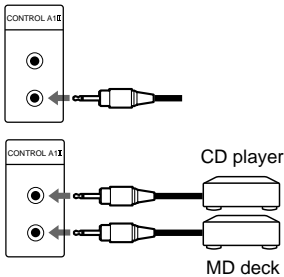

On CONTROL A1 jacks and connections

It is possible to make connections between CONTROL A1 and CONTROL A1II jacks. For details regarding particular connections or set up options, refer to the operating instructions supplied with the component(s).

About the connecting cord

Some CONTROL A1 compatible components are supplied with a connecting cord as an accessory. In this case, use the connecting cord for your connection.

When using a commercially available cord, use a monaural (2P) mini-plug cord less than 2 meters long, with no resistance.

Basic Functions

The CONTROL A1II functions will operate as long as the component you want to operate is turned on, even if all of the other connected components are not turned on.

■ Automatic function selection

When you connect a CONTROL A1II compatible Sony amplifier (or receiver) to other Sony components using monaural mini-plug cords, the function selector on the amplifier (or receiver) automatically switches to the correct input when you press the play button on one of the connected components.

Notes

- You must connect a CONTROL A1 compatible amplifier (receiver) using a monaural mini-plug cord in order to take advantage of the automatic function selection feature.
- This function only works when the components are connected to the amplifier (or receiver) inputs according to the names on the function buttons. Certain receivers allow you to switch the names of the function buttons. In this case, refer to the operating instructions supplied with the receiver.
- When recording, do not play any components other than the recording source. It will cause the automatic function selection to operate.

continued

CONTROL A1II control system (continued)

■ Synchronized recording

This function lets you conduct synchronized recording between the selected source and recorder components.

- 1** Set the function selector on the amplifier (or receiver) to the source component.
- 2** Set the source component to pause mode (make sure both the ► and ■■ indicators light together).
- 3** Set the recorder component to the REC-PAUSE mode.
- 4** Press PAUSE on the recorder component.
The source component is released from the pause mode, and recording begins shortly thereafter.
When playback ends from the source component, recording stops.

Notes

- Do not set more than one component to the pause mode.
- Certain recorder components may be equipped with a special synchronized recording function that uses the CONTROL A1II Control System, like “CD Synchro Dubbing”. In this case, refer to the operating instructions supplied with the recorder component.

Except for models of area code U, CA

You can use the remote RM-U305C to operate the components in your system.

Before you use your remote

Inserting batteries into the remote

Insert R6 (size-AA) batteries with the + and – properly oriented in the battery compartment. When using the remote, point it at the remote sensor  on the receiver.

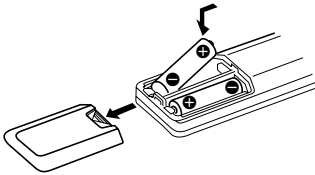

Tip

Under normal conditions, the batteries should last for about 6 months. When the remote no longer operates the receiver, replace all batteries with new ones.

Notes

- Do not leave the remote in an extremely hot or humid place.
- Do not use a new battery with an old one.
- Do not expose the remote sensor to direct sunlight or lighting apparatuses. Doing so may cause a malfunction.
- If you don't use the remote for an extended period of time, remove the batteries to avoid possible damage from battery leakage and corrosion.

Remote button description

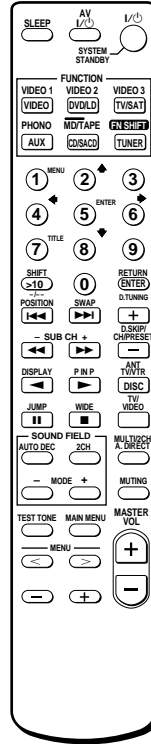

The tables below show the settings of each button.

Remote Button	Operations	Function
SLEEP	Receiver	Activates the sleep function and the duration which the receiver turns off automatically.
I/O	Receiver	Turns the receiver on or off.

continued



Remote button description (continued)

Remote Button	Operations	Function
VIDEO/ VIDEO 1*	Receiver	To watch VCR. (VTR mode 3)
VIDEO 2*	Receiver	To watch VCR. (VTR mode 1)
VIDEO 3*	Receiver	To watch VCR. (VTR mode 2)
DVD/LD	Receiver	To watch DVD or laser disc.
TV/SAT	Receiver	To watch TV programs or satellite receiver.
PHONO*	Receiver	To listen to turntable.
MD/ TAPE*:**	Receiver	To listen to Minidisc or audio tape.
AUX	Receiver	To listen to an audio equipment.
CD/SACD	Receiver	To listen to compact disc.
TUNER	Receiver	To listen to radio programs.
SHIFT	Receiver	Press repeatedly to select a memory page for presetting radio stations or tuning to preset stations.
D.TUNING	Receiver	Tuner station direct key-in-mode.
AUTO DEC	Receiver	Select AUTO DECODING mode.
MODE+/-	Receiver	Selects sound field mode.
2CH	Receiver	Select 2CH mode.
MULTI/2CH A.DIRECT***	Receiver	Selects MULTI CH IN source.
MUTING	Receiver	Mutes the sound from the receiver

* VIDEO 1, VIDEO 2, VIDEO 3, PHONO and MD/TAPE function is a 2-key operation. To select the above function, press FN SHIFT (function shift) and the function key you want simultaneously. For example, press FN SHIFT and CD/SACD to select MD/TAPE function.

** You cannot operate the Sony tape deck. To operate the Sony tape deck, follow the procedure of "Changing the factory setting of a function button" (page 56) and assign a function button which is not used (AUX, etc.) to the tape deck.

***Analog direct is not supported.

Remote Button	Operations	Function
TEST TONE	Receiver	Press to output test tone.
MAIN MENU	Receiver	Press this button repeatedly to select one of the five cursor modes: EQ, SURROUND, LEVEL, SET UP and CUSTOMIZE.
MENU </>	Receiver	Selects a menu item.
MENU +/-	Receiver	Makes adjustment or change the setting.
MASTER VOL +/-	Receiver	Adjusts the master volume of the receiver.
AV I/ 	TV/VCR/ CD player/ VCD player/ LD player/ DVD player/ MD deck/ DAT deck	Turns the audio and video components on or off.
SYSTEM STANDBY (Press AV I/  and I/  at the same time)	Receiver/TV/ VCR/Satellite tuner/ CD player/ VCD player/ LD player/ DVD player/ MD deck/ DAT deck/ TAPE deck	Turns off the receiver and other Sony audio/video components.
0-9	Receiver	Use with "SHIFT" button to select tuner preset station numeric input during DIRECT TUNING or MEMORY mode.
	CD player/ VCD player/ LD player/ MD deck/ DAT deck	Selects track numbers. 0 selects track 10.
	TV/VCR/ satellite tuner	Selects channel numbers.
>10	CD player/ VCD player/ LD player/ MD deck/ Tape deck	Selects tracks numbers over 10.

Remote Button	Operations	Function
ENTER	TV/VCR/ satellite tuner/ LD player/ MD deck/ DAT deck/ Tape deck	After selecting a channel, disc or track using the numeric buttons, press to enter the value.
D. SKIP/ CH/PRESET +/-	Receiver TV/VCR/ satellite tuner CD player/ VCD player/ DVD player/ MD deck	Scans and selects preset stations. Selects preset channel. Skips discs (multi-disc changer only).
◀◀/▶▶	VCR/ CD player/ VCD player/ LD player/ DVD player/ MD deck/ DAT deck/ Tape deck	Skip tracks.
◀◀/▶▶	CD player/ VCD player/ DVD player VCR/ LD player/ MD deck/ DAT deck/ Tape deck	Search tracks (forward or backward) Fastforwards or rewinds.
◀	Tape deck	Starts play on the reverse side.
▶	VCR/ CD player/ VCD player/ LD player/ DVD player/ MD deck/ DAT deck/ Tape deck	Starts play.

Remote Button	Operations	Function
⏸	VCR/ CD player/ VCD player/ LD player/ DVD player/ MD deck/ DAT deck/ Tape deck	Pauses play or record. (Also start recording with components in record standby.)
■	VCR/ CD player/ VCD player/ LD player/ DVD player/ MD deck/ DAT deck/ Tape deck	Stops play.
DISPLAY	TV/VCR/ VCD player/ LD player/ DVD player	Selects information displayed on the TV screen.
ANT TV/VTR	VCR	Selects output signal from the aerial terminal: TV signal or VCR program.
DISC	CD player	Select discs (multi-disc changer only).
TITLE	DVD player	Displays DVD title.
MENU	DVD player	Displays DVD menu.
ENTER	DVD player	Enters the selection.
RETURN	DVD player	Returns to previous menu or exits the menu.
⏪/⏩/⏴/⏵	DVD player	Selects a menu item.
-/-	TV	Selects the channel entry mode, either one or two digit

continued

Remote button description (continued)

Remote Button	Operations	Function
POSITION**TV		Changes the position of the small picture.
SWAP** TV		Swaps the small and the large picture.
SUB CH +/_**	TV	Selects the preset channels for the small picture.
P IN P**	TV	Activates the picture-in-picture function.
JUMP	TV	Toggles between the previous and the current channels.
WIDE	TV	Selects the wide picture mode.
TV/VIDEO	TV	Selects input signal: TV input or video input.

** Only for Sony TVs with the picture-in-picture function.

Notes

- When you press the function buttons (VIDEO 1, VIDEO 2, VIDEO 3, DVD/LD), the input mode of the TV might not switch to the corresponding input mode that you want. In this case, press the TV/VIDEO button to switch the input mode of the TV.
- Some functions explained in this section may not work depending on the model of the receiver.
- The above explanation is intended to serve as an example only. Therefore, depending on the component the above operation may not be possible or may operate differently than described.
- The TV/SAT and PHONO functions are not available for set operation.

Changing the factory setting of a function button

If the factory settings of the FUNCTION buttons do not match your system components, you can change them. For example, if you have an MD player and a tape deck and you don't have a CD player, you can assign the CD/SACD button to your tape deck.

Note that the settings of the TUNER and FN SHIFT functions (VIDEO 1, VIDEO 2, VIDEO 3, PHONO and MD/TAPE) button cannot be changed.

- 1 **Hold down the Function button whose function you want to change (for example, CD/SACD).**
- 2 **Press the corresponding button of the component you want to assign to the Function button (for example, 4 – Tape deck).**

The following buttons are assigned to select the functions:

To operate	Press
CD player	1
DAT deck	2
MD deck	3
Tape deck A	4
Tape deck B	5
LD player	6
VCR (command mode VTR 1*)	7
VCR (command mode VTR 2*)	8
VCR (command mode VTR 3*)	9
TV	0
DSS (Digital Satellite Receiver)	>10
DVD	ENTER
VCD player	◀◀

* Sony VCRs are operated with a VTR 1, 2 or 3 setting. These correspond to Beta, 8mm and VHS respectively.

Now you can use the CD/SACD button to control the tape deck.

To reset a button to its factory setting

Repeat the above procedure.

To reset all the function buttons to their factory setting

Press I/⏪, AV I/⏪ and MASTER VOL – at the same time.

Precautions

On safety

Should any solid object or liquid fall into the cabinet, unplug the receiver and have it checked by qualified personnel before operating it any further.

On power sources

- Before operating the unit, check that the operating voltage is identical with your local power supply. The operating voltage is indicated on the nameplate at the rear of the receiver.
- The unit is not disconnected from the AC power source (mains) as long as it is connected to the wall outlet, even if the receiver itself has been turned off.
- If you are not going to use the receiver for a long time, be sure to disconnect the receiver from the wall outlet. To disconnect the AC power cord, grasp the plug itself; never pull the cord.
- (Models of area code U, CA only)
One blade of the plug is wider than the other for the purpose of safety and will fit into the wall outlet only one way. If you are unable to insert the plug fully into the outlet, contact your dealer.
- AC power cord must be changed only at the qualified service shop.

On heat buildup

Although the unit heats up during operation, this is not a malfunction. If you continuously use this unit at a large volume, the cabinet temperature of the top, side and bottom rises considerably. To avoid burning yourself, do not touch the cabinet.

On placement

- Place the receiver in a location with adequate ventilation to prevent heat buildup and prolong the life of the receiver.
- Do not place the receiver near heat sources, or in a place subject to direct sunlight, excessive dust or mechanical shock.
- Do not place anything on top of the cabinet that might block the ventilation holes and cause malfunctions.

On operation

Before connecting other components, be sure to turn off and unplug the receiver.

On cleaning

Clean the cabinet, panel and controls with a soft cloth slightly moistened with a mild detergent solution. Do not use any type of abrasive pad, scouring powder or solvent such as alcohol or benzene.

If you have any question or problem concerning your receiver, please consult your nearest Sony dealer.

Troubleshooting

If you experience any of the following difficulties while using the receiver, use this troubleshooting guide to help you remedy the problem. Should any problem persist, consult your nearest Sony dealer.

There is no sound no matter which component is selected.

- Check that both the receiver and all components are turned on.
- Check that the MASTER VOLUME control is not set at $-\infty$ dB.
- Check that the SPEAKERS ON/OFF is not set to OFF (page 24).
- Check that all speaker cords are connected correctly.
- Press MUTING on the remote to cancel the muting function.

"NOT PCM" appears in the display and no sound is heard.

- Set "DEC." to "DEC. AUTO" in the CUSTOMIZE menu (page 40).

There is no sound from a specific component.

- Check that the component is connected correctly to the audio input jacks for that component.
- Check that the cord(s) used for the connection is (are) fully inserted into the jacks on both the receiver and the component.

There is no sound from one of the front speakers.

- Connect a pair of headphones to the PHONES jack to verify that sound is output from the headphones.

If only one channel is output from the headphones, the component may not be connected to the receiver correctly. Check that all the cords are fully inserted into the jacks on both the receiver and the component.

If both channels are output from the headphones, the front speaker may not be connected to the receiver correctly. Check the connection of the front speaker which is not outputting any sound.

continued

Troubleshooting (continued)

There is no sound or only a very low-level sound is heard.

- Check that the speakers and components are connected securely.
- Check that you have selected the correct component on the receiver.
- Check that the SPEAKERS ON/OFF is not set to OFF (page 24).
- Check that the headphones are not connected.
- Press MUTING on the remote to cancel the muting function.
- The protective device on the receiver has been activated because of a short circuit. Turn off the receiver, eliminate the short-circuit problem and turn on the power again.

The left and right sounds are unbalanced or reversed.

- Check that the speakers and components are connected correctly and securely.
- Adjust balance parameters in the LEVEL menu.

There is severe hum or noise.

- Check that the speakers and components are connected securely.
- Check that the connecting cords are away from a transformer or motor, and at least 3 meters away from a TV set or fluorescent light.
- Move your TV away from the audio components.
- Make sure you have grounded the SIGNAL GND terminal (only when a turntable is connected).
- The plugs and jacks are dirty. Wipe them with a cloth slightly moistened with alcohol.

There is no sound from the center speaker.

- Make sure the sound field function is on (press MODE +/-).
- Select the CINEMA STUDIO EX mode (page 34).
- Adjust the speaker level (page 23).
- Make sure the center speaker size parameter is set to either "SMALL" or "LARGE" (page 21).

There is no sound or only a very low-level sound is heard from the surround speakers.

- Make sure the sound field function is on (press MODE +/-).
- Select the CINEMA STUDIO EX mode (page 34).
- Adjust the speaker level (see page 23).
- Make sure the surround speaker size parameter is set to either "SMALL" or "LARGE" (page 22).

The surround effect cannot be obtained.

- Make sure the sound field function is on (press MODE +/-).
- Sound fields do not function for the signals with a sampling frequency of more than 48 kHz.

Dolby Digital or DTS multi channel sound is not reproduced.

- Check that the playing DVD, etc. is recorded in Dolby Digital or DTS format.
- When connecting the DVD player, etc. to the digital input jacks of this receiver, check the audio setting (settings for the audio output) of the connected component.

Recording cannot be done.

- Check that the components are connected correctly.
- Select the source component with FUNCTION control.
- When recording from a digital component, make sure the INPUT MODE is set to ANALOG (page 37) before recording with a component connected to the analog MD/TAPE terminals.
- When recording from a digital component, make sure the INPUT MODE is set to COAX IN or OPT IN (page 37) before recording with the component connected to the DIGITAL MD/TAPE OUT terminals.

To connect an LD player via an RF demodulator

- Connect the LD player to the RF demodulator, then connect the RF demodulator's optical or coaxial digital output to the receiver's DVD/LD OPTICAL IN or COAXIAL jack. When making this connection, be sure to set INPUT MODE manually (page 37). The receiver may not operate correctly if INPUT MODE is set to AUTO IN.

For details on DOLBY DIGITAL RF hookups, see the operating instructions supplied with your RF demodulator.

The FM reception is poor.

- Use a 75-ohm coaxial cable (not supplied) to connect the receiver to an outdoor FM antenna as shown below. If you connect the receiver to an outdoor antenna, ground it against lightning. To prevent a gas explosion, do not connect the ground wire to a gas pipe.

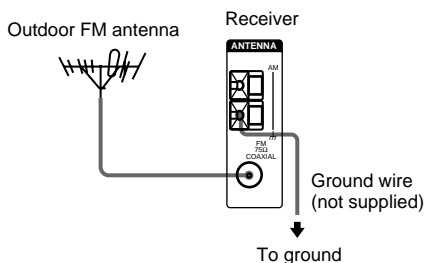
**Radio stations cannot be tuned in.**

- Check that the antennas are connected securely. Adjust the antennas and connect an external antenna if necessary.
- The signal strength of the stations is too weak (when tuning in with automatic tuning). Use direct tuning.
- Make sure you set the tuning interval correctly (when tuning in AM stations with direct tuning).
- No stations have been preset or the preset stations have been cleared (when tuning by scanning preset stations). Preset the stations (page 27).
- Press DISPLAY so that the frequency appears in the display.

RDS does not work.*

- Make sure that you're tuned to an FM RDS station.
- Select a stronger FM station.

The RDS information that you want does not appear.*

- Contact the radio station and find out whether or not they actually provide the service in question. If so, the service may be temporarily out of order.

There is no picture or an unclear picture appears on the TV screen or monitor.

- Select the appropriate function on the receiver.
- Set your TV to the appropriate input mode.
- Move your TV away from the audio components.

Remote control**The remote does not function.**

- Point the remote at the remote sensor  on the receiver.
- Remove any obstacles in the path between the remote and the receiver.
- Replace all the batteries in the remote with new ones, if they are weak.
- If the receiver's COMMAND MODE and the remote's COMMAND MODE do not match, transmission is not possible between the remote and the receiver (page 41).
- Make sure you select the correct function on the remote.
- When you operate a programmed non-Sony component, the remote may not function properly depending on the model and the make of the component.

Reference sections for clearing the memory

To clear	See
All memorized settings	page 20
Customized sound fields	page 38

* Models of area code CEL, CEK only.

Specifications

AUDIO POWER SPECIFICATIONS

POWER OUTPUT AND TOTAL HARMONIC DISTORTION:

(Models of area code U only)

With 8 ohm loads, both channels driven, from 20 – 20,000 Hz; rated 100 watts per channel minimum RMS power, with no more than 0.05 % total harmonic distortion from 250 milliwatts to rated output.

Amplifier section

POWER OUTPUT

Models of area code U, CA

Rated Power Output at Stereo Mode

(8 ohms 20 Hz – 20 kHz, THD 0.09 %)

100 W + 100 W

(4 ohms 20 Hz – 20 kHz, THD 0.09 %)

80 W + 80 W

Reference Power Output

(8 ohms 20 Hz – 20 kHz, THD 0.09 %)

FRONT¹⁾: 100 W + 100 W

CENTER¹⁾: 100 W

SURR¹⁾: 100 W + 100 W

(4 ohms 20 Hz – 20 kHz, THD 0.09 %)

FRONT¹⁾: 80 W + 80 W

CENTER¹⁾: 80 W

SURR¹⁾: 80 W + 80 W

Models of other area codes

Rated Power Output at Stereo Mode

(8 ohms 1 kHz, THD 0.7 %)

100 W + 100 W²⁾

90 W + 90 W³⁾

(4 ohms 1 kHz, THD 0.7 %)

90 W + 90 W²⁾

80 W + 80 W³⁾

Reference Power Output²⁾

(8 ohms 1 kHz, THD 0.7 %)

FRONT¹⁾: 100 W + 100 W

CENTER¹⁾: 100 W

SURR¹⁾: 100 W + 100 W

(4 ohms 1 kHz, THD 0.7 %)

FRONT¹⁾: 80 W + 80 W

CENTER¹⁾: 80 W

SURR¹⁾: 80 W + 80 W

(8 ohms 20 Hz – 20 kHz, THD 0.09 %)

FRONT¹⁾: 90 W + 90 W

CENTER¹⁾: 90 W

SURR¹⁾: 90 W + 90 W

(4 ohms 20 Hz – 20 kHz, THD 0.09 %)

FRONT¹⁾: 75 W + 75 W

CENTER¹⁾: 75 W

SURR¹⁾: 75 W + 75 W

1) Depending on the sound field settings and the source, there may be no sound output.

2) Measured under the following conditions:

Area code	Power requirements
SP, CEL, CEK	230 V AC, 50 Hz
TW	110 V AC, 60 Hz

3) Measured under the following conditions:

Area code	Power requirements
CN, KR	220 V AC, 50 Hz

Frequency response

PHONO	RIAA equalization curve ±0.5 dB
CD/SACD, MD/ TAPE, TV/SAT, DVD/LD, VIDEO 1, 2, 3	10 Hz – 100 kHz +0.5/-2 dB (with sound field and equalizer bypassed)

Inputs (Analog)

PHONO	Sensitivity: 2.5 mV Impedance: 50 kilohms S/N ⁴⁾ : 86 dB (A, 2.5 mV ⁵⁾)
MULTI CH IN, CD/ SACD, MD/TAPE, DVD/LD, TV/SAT, VIDEO 1, 2, 3	Sensitivity: 150 mV Impedance: 50 kilohms S/N ⁴⁾ : 100 dB (A, 150 mV ⁵⁾)

4) INPUT SHORT.

5) Weighted network, input level.

Inputs (Digital)

ASSIGNABLE	Impedance: 75 ohms
COAXIAL IN (DVD/ LD CD/SACD)	S/N: 100 dB (A, 20 kHz LPF)
DVD/LD, TV/SAT, MD/TAPE (Optical)	S/N: 100 dB (A, 20 kHz LPF)

Outputs

MD/TAPE (REC OUT), VIDEO 1, 2 (AUDIO OUT)	Voltage: 150 mV Impedance: 10 kilohms
FRONT L/R, CENTER, SURROUND L/R, SUB WOOFER (Models of area code U, CA only)	Voltage: 2 V Impedance: 1 kilohms
SUB WOOFER (Models of other area codes)	Voltage: 2 V Impedance: 1 kilohms

EQ

BASS:	99 Hz~1.0 kHz (21 steps)
TREBLE:	1.0 kHz~10 kHz (23 steps)
Gain levels:	±10 dB, 0.5 dB step

FM tuner section

Tuning range	87.5 - 108.0 MHz
Antenna terminals	75 ohms, unbalanced
Sensitivity	
Mono:	18.3 dBf, 2.2 μ V/75 ohms
Stereo:	38.3 dBf, 22.5 μ V/75 ohms
Usable sensitivity	11.2 dBf, 1 μ V/75 ohms
S/N	
Mono:	76 dB
Stereo:	70 dB
Harmonic distortion at 1 kHz	
Mono:	0.3%
Stereo:	0.5%
Separation	45 dB at 1 kHz
Frequency response	30 Hz – 15 kHz, +0.5/-2 dB
Selectivity	60 dB at 400 kHz

AM tuner section

Tuning range

Models of area code U, CA

With 10-kHz tuning scale: 530 – 1,710 kHz⁶⁾

With 9-kHz tuning scale: 531 – 1,710 kHz⁶⁾

Models of area code CN, SP, CEL, CEK, TW, KR

With 9-kHz tuning scale: 531 – 1,602 kHz

Antenna	Loop antenna
Usable sensitivity	50 dB/m (at 1,000 kHz or 999 kHz)
S/N	54 dB (at 50 mV/m)
Harmonic distortion	0.5 % (50 mV/m, 400 Hz)
Selectivity	
At 9 kHz:	35 dB
At 10 kHz:	40 dB

6) You can change the AM tuning scale to 9 kHz or 10 kHz. After tuning in any AM station, turn off the receiver. Hold down TUNING + and press I/⏻. All preset stations will be erased when you change the tuning scale. To reset the scale to 10 kHz (or 9 kHz), repeat the procedure.

Video section

Inputs/Outputs

Video:	1 Vp-p, 75 ohms
S-video:	Y: 1 Vp-p, 75 ohms C: 0.286 Vp-p, 75 ohms

COMPONENT VIDEO

(Except for models of area code CEL, CEK):
Y: 1 Vp-p, 75 ohms
B-Y: 0.7 Vp-p, 75 ohms
R-Y: 0.7 Vp-p, 75 ohms

continued

Specifications (continued)

General

Power requirements

Area code	Power requirements
U, CA	120 V AC, 60 Hz
CEL, CEK	230 V AC, 50/60 Hz
CN, SP, KR	220 – 230 V AC, 50/60 Hz
TW	110 V AC, 60 Hz

Power consumption

Area code	Power consumption
U	280 W
CA	330 VA
CEL, CEK	290 W
CN, SP, KR	290 W
TW	290 W (MAX 500W)

Power consumption (during standby mode)

0.5 W

AC outlets

Area code	AC outlets
U, CA	1 switched, 120 W/1A MAX
SP, TW	1 switched, 100 W MAX

Dimensions 430 × 161 × 400 mm
including projecting parts
and controls

Mass (Approx.) 12.5 kg

Supplied accessories

FM wire antenna (1)

AM loop antenna (1)

Models of area code U, CA;

Remote commander RM-PP506L (1)

R6 (size-AA) batteries (2)

Models of other area codes;

Remote commander RM-U305C (1)

R6 (size-AA) batteries (2)

For details on the area code of the component you are using, see page 3.

Design and specifications are subject to change without notice.

Index

A, B

Adjusting

- brightness of the display 30
- CUSTOMIZE parameters 40, 47
- EQ parameters 39, 46
- LEVEL parameters 38, 45
- speaker volumes 23
- SET UP parameters 21, 41
- SURROUND parameters 37, 44

Automatic tuning 25

C

Changing

- display 30
- effect level 37

Clearing receiver's memory 20

Crossover frequency 40

CUSTOMIZE menu 40, 47

D

Digital Cinema Sound 34

Direct tuning 25

Dubbing. See Recording

E, F, G, H

Editing. See Recording

Effect level 37

EQ menu 39, 46

I, J, K

Indexing. See Naming

L, M

Labeling. See Naming

LEVEL menu 38, 45

N, O

Naming 47

P, Q

Preset stations

- how to preset 26
- how to tune 27

R

RDS 27

Recording

- on an audio tape or MD 48
- on a video tape 48

S

Scanning

- preset stations. See Preset tuning
- radio stations. See Automatic tuning

Selecting

- component 24
- sound field 34

SET UP menu 21, 41

Sleep timer 47

Sound field

- customizing 37
- pre-programmed 34, 35
- resetting 38
- selecting 34

Speakers

- adjusting speaker volume 23
- connection 19
- impedance 18
- placement 18

Supplied accessories 62

SURROUND menu 37, 44

T, U, V, W, X, Y, Z

Test tone 23

Tuning

- automatically 25
- directly 25
- preset stations 26

