

# *Mini Hi-Fi Component System*

---

## Operating Instructions

### Owner's Record

The model and serial numbers are located on the rear of the unit. Record the serial number in the space provided below. Refer to them whenever you call upon your Sony dealer regarding this product.

Model No. \_\_\_\_\_

Serial No. \_\_\_\_\_



***MHC-GSX100W***  
***MHC-GSX75***

## WARNING

### To prevent fire or shock hazard, do not expose the unit to rain or moisture.

To prevent fire, do not cover the ventilation of the apparatus with news papers, table-cloths, curtains, etc. And don't place lighted candles on the apparatus.

To prevent fire or shock hazard, do not place objects filled with liquids, such as vases, on the apparatus.

Do not install the appliance in a confined space, such as a bookcase or built-in cabinet.

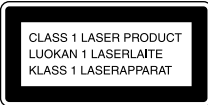

This appliance is classified as a CLASS 1 LASER product. This marking is located on the rear exterior.

### NOTICE FOR THE CUSTOMERS IN THE U.S.A.

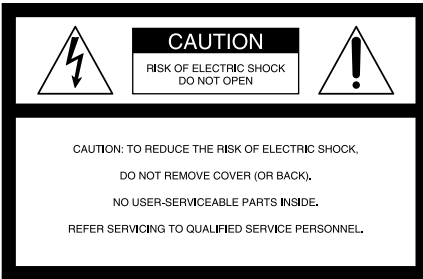

This symbol is intended to alert the user to the presence of uninsulated "dangerous voltage" within the product's enclosure that may be of sufficient magnitude to constitute a risk of electric shock to persons.



This symbol is intended to alert the user to the presence of important operating and maintenance (servicing) instructions in the literature accompanying the appliance.

### CAUTION

The use of optical instruments with this product will increase eye hazard.

### Note to CATV system installer:

This reminder is provided to call the CATV system installer's attention to Article 820-40 of the NEC that provides guidelines for proper grounding and, in particular, specifies that the cable ground shall be connected to the grounding system of the building, as close to the point of cable entry as practical.

### WARNING

This equipment has been tested and found to comply with the limits for a Class B digital device, pursuant to Part 15 of the FCC Rules. These limits are designed to provide reasonable protection against harmful interference in a residential installation. This equipment generates, uses, and can radiate radio frequency energy and, if not installed and used in accordance with the instructions, may cause harmful interference to radio communications. However, there is no guarantee that interference will not occur in a particular installation. If this equipment does cause harmful interference to radio or television reception, which can be determined by turning the equipment off and on, the user is encouraged to try to correct the interference by one or more of the following measures:

- Reorient or relocate the receiving antenna.
- Increase the separation between the equipment and receiver.
- Connect the equipment into an outlet on a circuit different from that to which the receiver is connected.
- Consult the dealer or an experienced radio/TV technician for help.

### CAUTION

You are cautioned that any changes or modifications not expressly approved in this manual could void your authority to operate this equipment.

### NOTICE FOR THE CUSTOMERS IN CANADA

#### CAUTION

TO PREVENT ELECTRIC SHOCK, MATCH WIDE BLADE OF PLUG TO WIDE SLOT, FULLY INSERT.

#### CAUTION

The use of optical instruments with this product will increase eye hazard.

NOTICE FOR THE CUSTOMERS IN THE  
U.S.A. (MHC-GSX100W only)

If you have any questions about this product, you may call;

Sony Customer Information Service Center  
1-800-222-7669 or <http://www.sony.com/>

The Number below is for the FCC related matters only.

Regulatory Information

Declaration of Conformity

Trade Name: SONY

Model No.: MHC-GSX100W

Responsible Party: Sony Electronics Inc.

Address: 16450 W. Bernardo Dr, San  
Diego, CA 92127 U.S.A.

Telephone No.: 858-942-2230

This device complies with Part 15 of the FCC Rules.  
Operation is subject to the following two  
conditions: (1) This device may not cause harmful  
interference, and (2) this device must accept any  
interference received, including interference that  
may cause undesired operation.

NOTICE FOR THE CUSTOMERS IN THE  
CANADA

Operation is subject to the following two conditions:  
(1) this device may not cause interference, and (2) this  
device must accept any interference, including  
interference that may cause undesired operation of the  
device.

Son utilisation est autorisée seulement aux conditions  
suivantes: (1) il ne doit pas produire de brouillage et (2)  
l'utilisateur du dispositif doit être prêt à accepter tout  
brouillage radioélectrique reçu, même si ce brouillage  
est susceptible de compromettre le fonctionnement du  
dispositif.

NOTICE FOR THE CUSTOMERS IN THE  
U.S.A AND CANADA

Replace the AC power adaptor with model  
AC-GSX100 only, if replacement is necessary.





ENERGY STAR<sup>®</sup> is a U.S.  
registered mark. As an ENERGY  
STAR<sup>®</sup> partner, Sony Corporation  
has determined that this product  
meets the ENERGY STAR<sup>®</sup>  
guidelines for energy efficiency.

# Table of Contents

How to use this manual.....	5	Mixing video game sound with other sound source.....	25
Playable discs.....	5	— Game Mixing	
<hr/>			
<b>Getting Started</b>			
Hooking up the system.....	7	<b>Timer</b>	
Setting the clock.....	8	Falling asleep to music .....	26
<hr/>			
<b>Wireless</b>			
Hooking up the transmitter .....	9	— Sleep Timer	
(MHC-GSX100W only)		Waking up to music .....	26
Listening to audio using wireless		— Daily Timer	
system .....	11	Timer recording radio programs.....	27
(MHC-GSX100W only)		<hr/>	
<b>CD/MP3 – Play</b>			
Loading a disc .....	13	<b>Display</b>	
Playing a disc .....	14	Turning off the display .....	29
— Normal Play/Shuffle Play		— Power Saving Mode	
Playing repeatedly.....	16	Viewing information about the disc	
— Repeat Play		in the display .....	29
Creating your own program.....	16	Changing the Power illuminator.....	30
— Program Play		<hr/>	
Labeling a disc .....	17	<b>Using an Optional Keyboard</b>	
— Disc Memo		Setting the keyboard.....	30
<hr/>			
<b>Tuner</b>			
Presetting radio stations .....	19	Labeling titles through the keyboard....	31
Listening to the radio .....	20	Operating the system through the	
— Preset Tuning		keyboard.....	31
— Manual Tuning		<hr/>	
Labeling the preset stations.....	21	<b>Optional Components</b>	
— Station Name		Hooking up optional components.....	32
<hr/>			
<b>Tape – Play</b>			
Loading a tape.....	21	Listening to audio from a connected	
Playing a tape.....	22	component .....	33
<hr/>			
<b>Tape – Recording</b>			
Recording on a tape .....	22	Recording audio from a connected	
<hr/>			
<b>Sound Adjustment</b>			
Adjusting the sound .....	24	component .....	33
Enhancing video game sound .....	25	Recording on a connected	
— Game Sync		component .....	33
<hr/>			
<b>Troubleshooting</b>			
		Problems and remedies.....	34
		Messages.....	37
<hr/>			
<b>Additional Information</b>			
		Precautions .....	38
		Specifications .....	39
		List of button locations and	
		reference pages.....	42

## How to use this manual







- This manual mainly explains operations using the remote, but the same operations can also be performed using the buttons on the system having the same or similar names.
- The following symbols are used in this manual.

Symbol	Meaning
	Functions that can be used with audio CDs
	Functions that can be used with MP3

## Playable discs

You can play back the following discs on this system. Other discs cannot be played back.

### List of playable discs

Format of discs	Disc logo	Contents
Audio CDs		Audio
CD-R/CD-RW (audio data)	 	Audio
CD-R/CD-RW (MP3 files)	   	Audio

## Discs that this system cannot play

- CD-ROMs
- CD-Rs/CD-RWs other than those recorded in the following formats:
  - music CD format
  - MP3 format that conforms to ISO9660\*<sup>1</sup> Level 1/Level 2, Joliet or Multi Session\*<sup>2</sup>
- A disc that has a non-standard shape (e.g., card, heart).
- A disc with paper or stickers on it.
- A disc that has the adhesive, cellophane tape, or a sticker still left on it.

\*<sup>1</sup> ISO 9660 Format

The most common international standard for the logical format of files and folders on a CD-ROM. There are several specification levels. In Level 1, file names must be in the 8.3 format (no more than eight characters in the name, no more than three characters in the extension “.MP3”) and in capital letters. Folder names can be no longer than eight characters. There can be no more than eight nested folder levels. Level 2 specifications allow file names and folder names up to 31 characters long. Each folder can have up to 8 trees.

For Joliet in the expansion format (file and folder names can have up to 64 characters) make sure of the contents of the writing software, etc.

\*<sup>2</sup> Multi Session

This is a recording method that enables adding of data using the Track-At-Once method.

Conventional CDs begin at a CD control area called the Lead-in and end at an area called Lead-out. A Multi Session CD is a CD having multiple sessions, with each segment from Lead-in to Lead-out regarded as a single session.

CD-Extra: This format records audio (audio CD data) on the tracks in session 1 and data on the tracks in session 2.

Mixed CD: This format records data on the first track and audio (audio CD data) on the second and subsequent tracks of a session.

---

## Notes on CD-R and CD-RW

- This system can play CD-R/CD-RW discs edited by the user. However, note that playback of some discs may not be possible depending on the recording device used for recording or the disc condition.
- Discs recorded on CD-R/CD-RW drives may not be played back because of scratches, dirt, recording condition or the driver's characteristics.
- CD-R and CD-RW discs that have not been finalized (processing to allow play by a normal CD player) cannot be played.
- CD-R and CD-RW discs recorded in multi-session that have not ended by "closing the session" are not supported.
- The system may be unable to play MP3 format files that do not have the extender ".MP3".
- Attempting to play non-MP3 format files that have the extender ".MP3" may result in noise or malfunction.
- With formats other than ISO 9660 level 1 and 2, folder names or file names may not be displayed correctly.
- The following discs take a longer time to start playback.
  - a disc recorded with complicated tree structure.
  - a disc recorded in Multi Session.
  - a disc to which data can be added (non-finalized disc).

---

## Music discs encoded with copyright protection technologies

This product is designed to playback discs that conform to the Compact Disc (CD) standard. Recently, various music discs encoded with copyright protection technologies are marketed by some record companies. Please be aware that among those discs, there are some that do not conform to the CD standard and may not be playable by this product.

---

## Cautions when playing a disc that is recorded in Multi Session

- If the disc begins with a CD-DA session, it is recognized as a CD-DA (audio) disc, and MP3 sessions are played back without sound.
- If the disc begins with an MP3 session, it is recognized as an MP3 disc, and CD-DA sessions are played back without sound.
- The playback range of an MP3 disc is determined by the tree structure of files produced by analyzing of the disc.
- A disc with a mixed CD format will be recognized as a CD-DA (audio) disc.

# Hooking up the system

Perform the following procedures **1** to **3** to hook up your system using the supplied cords and accessories.

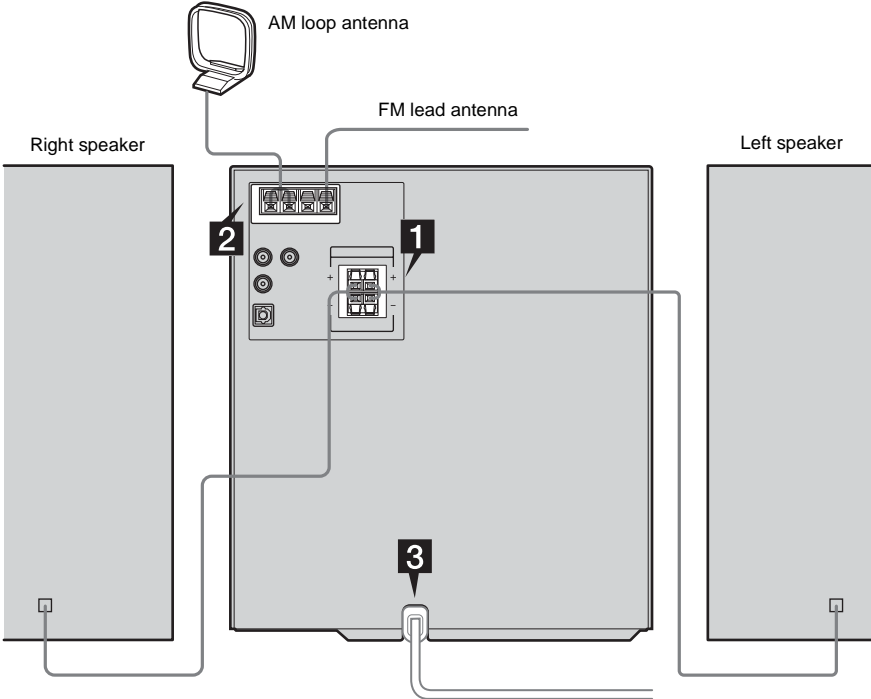

**1** Connect the speakers.

Connect the right and left speaker cords to the SPEAKER jacks as shown below.

Insert only the stripped portion

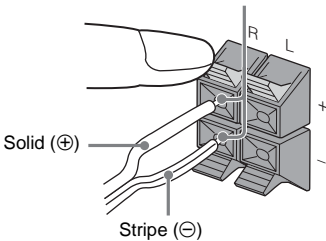

**2** Connect the FM and AM antennas.

Set up the AM loop antenna, then connect it.

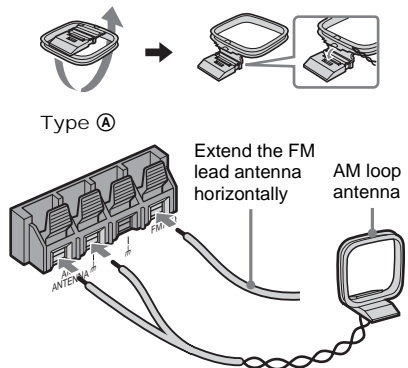

continued

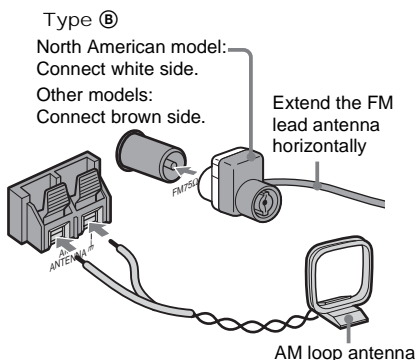

#### Note

Keep the antennas away from the speaker cords to prevent noise.

### 3 Connect the power cord to a wall outlet.

The demonstration appears in the display. When you press I/⏻, the system turns on and the demonstration automatically ends. You can cancel the demonstration by pressing DISPLAY repeatedly (page 29).

#### Note on placement

Be sure to place this unit on a horizontal place. If the unit is slanted, it may cause malfunction or damage to the system.

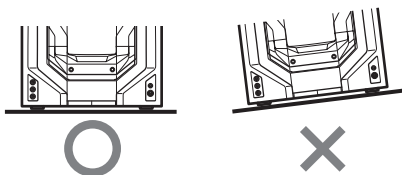

## Inserting two size AA (R6) batteries into the remote

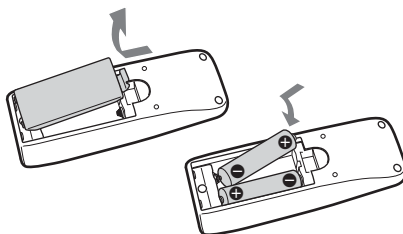

#### Note

If you do not use the remote for a long period of time, remove the batteries to avoid possible damage from battery leakage and corrosion.

#### Tip

With normal use, the batteries should last for about six months. When the remote no longer operates the system, replace both batteries with new ones.

## Setting the clock

- 1 Press I/⏻ to turn on the system.
  - 2 Press CLOCK/TIMER SET.
  - 3 Press ◀◀ or ▶▶ repeatedly to set the hour.
  - 4 Press ENTER.
  - 5 Press ◀◀ or ▶▶ repeatedly to set the minute.
  - 6 Press ENTER.
- The clock starts working.

#### To adjust the clock

- 1 Press CLOCK/TIMER SET.
- 2 Press ◀◀ or ▶▶ repeatedly to select "CLOCK SET", then press ENTER.
- 3 Do the same procedures as step 3 to 6 above.

#### Notes

- The clock settings are canceled when you disconnect the power cord or if a power failure occurs.
- You cannot set the clock in Power Saving Mode.



# Hooking up the transmitter

(MHC-GSX100W only)

## 1 Set the transmitter by the following procedures.

Select the hookup depending on the jack type of the optional component you want to connect the transmitter to.

### A To connect to the analog out jacks

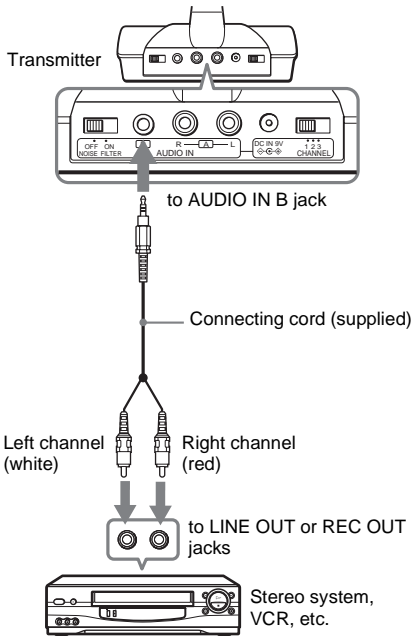

### B To connect to headphones jack

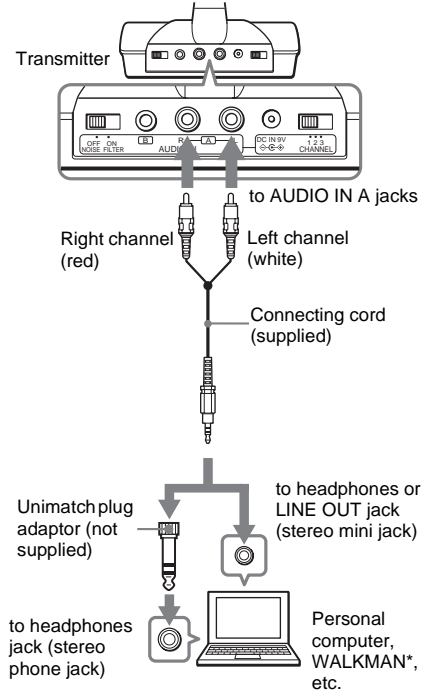

\* "WALKMAN" is a registered trademark of Sony Corporation.

"WALKMAN" is a trademark of Sony Corporation.

### C To connect to TV, etc.

If noise occurs when the transmitter is connected to the headphones jack of your TV or VCR, set the NOISE FILTER switch on the transmitter to ON.

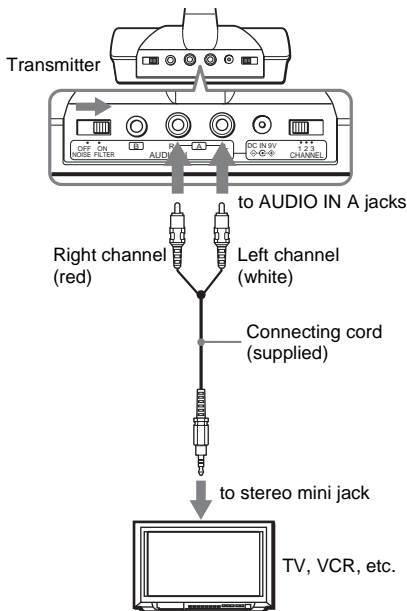

## 2 Connect the transmitter to a wall outlet using the supplied AC power adaptor.

The transmitter automatically turns on.

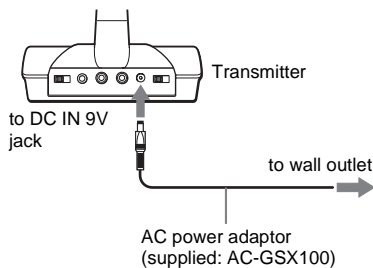

### Notes

- When you connect the transmitter to the analog out jacks, do not set the NOISE FILTER to ON. Otherwise, the volume will be limited.
- The NOISE FILTER effects the sound only in case of such as connections **B** and **C**. In connection **A**, the switch has no effect.

- For connections **B** and **C**, if stereo mini jack is connected to line out and the NOISE FILTER is set to ON, audio output will be reduced and audio signal may be intermittent or auto muting will activate. In this case, set the NOISE FILTER to OFF.
- When the transmitter is placed on or near a TV, it may pick up a noise. In such case, place the transmitter away from the TV.
- Use only the supplied AC power adaptor. Do not use any other AC power adaptor.



- If the connected component has the AVLS (Automatic Volume Limiter System) function, be sure to turn off the function when using the transmitter. Otherwise, you will have to turn up the volume of the speaker, and that may cause distortion.
- If the connected component has the BASS BOOST or MEGA BASS function, be sure to turn off the function when using the transmitter. Otherwise, the sound from the speaker may be distorted.
- Do not place the transmitter near a fluorescent lamp, etc. when using the system.
- When the source audio level is low or no audio signal is input for 10 seconds or more, the transmitter will switch to auto muting mode.
- If the transmitter does not detect an audio signal for a few minutes, the power on the transmitter automatically turns off. When the transmitter receives an audio signal again, the power automatically turns on.

## The effective areas of the transmitter

Wireless system that allows you to use your system free from the restriction of speaker cords. The optimum signal reception range is up to approximately 150 feet (46m) without the system picking up some interference. However, the distance may be reduced according to the surroundings and environment. If the system picks up some noise while using it within the above mentioned distance, reduce the distance between the transmitter unit and the main unit, or select another channel.

## Notes

- When you use the main unit inside the effective areas of the transmitter, the transmitter can be placed in any direction from the listener.
- Even within the signal reception area, there are some spots (dead spot) where the RF signal cannot be received. This is a characteristic inherent to RF signals, and does not indicate a malfunction. By slightly moving the transmitter, the location of the dead spot can be changed.

## Notes on receiving performance

This system component utilizes very high frequency signals in the 900 MHz band so the receiving performance may deteriorate due to the surroundings. The following examples illustrate conditions that may reduce the possible receiving range or cause interference with reception.

- Radio waves generated such as cellphones and cordless phone systems or metal instruments are placed on the unit.
- Inside a building with walls containing steel beams.
- Area with many steel file cabinets, etc.
- Area with many electrical appliances capable of generating electromagnetic noise.
- Transmitter is placed on a metal instrument.
- Area facing roadways.
- Noise or interfering signals exist in the surroundings due to radio transceivers in trucks, etc.
- Noise or interfering signals exist in the surroundings due to wireless communication systems installed along roadways.
- Transmitter is placed directly on floor. Placing it up off the floor, such as on a desk, is recommended.

## Listening to audio using wireless system

*(MHC-GSX100W only)*

- 1 Start playing the connected component.**
- 2 Press WIRELESS to switch the function to WIRELESS.**

When the sound is distorted

- 1** Move CHANNEL 1–3 on the transmitter to select a radio frequency.

CHANNEL1: 913.5 MHz

CHANNEL2: 914.0 MHz

CHANNEL3: 914.5 MHz

- 2** Press WIRELESS.  
“AUTO TUNING” appears.

If you do not hear clear audio, select another channel using CHANNEL 1-3, then press WIRELESS again.

To finish using WIRELESS function

Press any function button to select different function and quit WIRELESS.

## Notes

- You may not hear the beginning of the sound from the main unit until the transmitter starts sending the RF signals after detecting an audio signal.
- If the transmitter is connected to the headphones jack of the source component, set the volume of that component as high as possible without distorting the audio signal.
- If you hold the antenna of the transmitter with your hand, noise may occur. However this is not a malfunction.
- When the transmitter is not to be used for a long period of time, disconnect the AC power adaptor from the wall outlet holding the plug. Do not pull on the cord.

## Notes on sounds from the transmitter

When there is no sound, do the following:

- Check the connection of the optional component.
- Check that the optional component is turned on.
- Turn up the volume on the connected optional component, if the transmitter is connected to the headphones jack.
- Change the radio frequency using the CHANNEL selector on the transmitter, then press WIRELESS again.
- If you connect the transmitter to the analog out jacks of an audio reproducer, make sure that the NOISE FILTER switch is set to OFF.
- Make sure that the NOISE FILTER switch is set to either ON or OFF (If the switch gets stuck between ON and OFF, the sound will be cut off).

When there is severe hum or noise, do the following:

- If the transmitter is connected to the headphones jack, turn down the volume of the connected optional component. If the connected optional component has the BASS BOOST or MEGA BASS function, set these function to OFF.
- If the connected optional component has a LINE OUT jacks, connect its LINE OUT jacks.
- Change the radio frequency with the CHANNEL selector on the transmitter then press WIRELESS again.
- If you connect the transmitter to the analog out jacks of an audio reproducer, make sure that the NOISE FILTER switch is set to OFF.

## Loading a disc

You can load up to 60 discs into this unit.  
Turn on the system before you load discs.

You can also load and play discs with MP3 audio tracks.

- 1 **Open the front cover by pressing  $\blacktriangle$  PUSH on the front cover.**

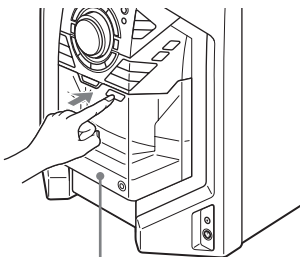

Front cover

\* MHC-GSX100W is used for illustration purpose.

- 2 **Press DISC + or – (or turn DISC SELECT on the unit) until you find the disc slot where you want to insert a disc, while checking the disc number (written beside every slot and also indicated in the display).**

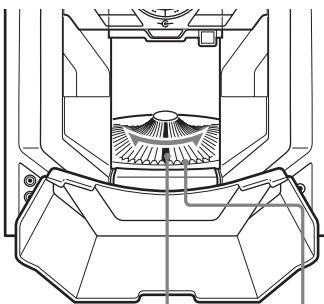

Disc slot at the loading position (located at the very front)

Disc number

The disc number\* at the loading position appears in the display. As you press DISC + or – (or turn DISC SELECT on the unit), the disc number changes.

\* If you have already loaded discs, the disc number at the playing position appears. When you press DISC + or – (or turn DISC SELECT on the unit), the displayed disc number changes to the one at the loading position.

Disc number



- 3 **Insert a disc with the label side facing right.**

Notes

- Make sure you have loaded the disc into each slot at a right angle to the rotary table. If the disc is not put in straight, it may damage the unit or the disc.
- Make sure the rotary table comes to a complete stop before loading or removing discs.

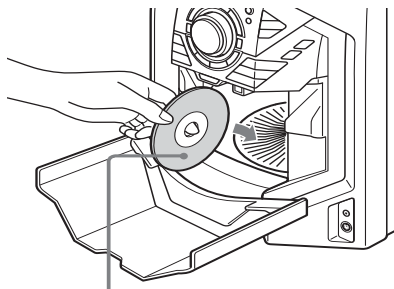

With the label side facing right

- 4 **Repeat steps 2 and 3 to load additional discs.**

- 5 Close the front cover by pressing**  
**▲ PUSH on the front cover.**

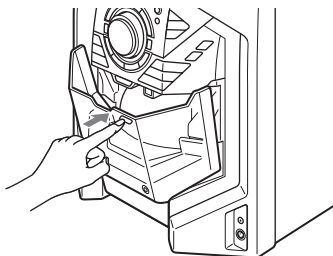

The rotary table turns and the disc slot at the loading position is set to the playing position.

### To remove the discs

After following step 1 of “Loading a disc” on page 13, remove the discs. Then close the front cover.

#### Notes

- Always close the front cover except when you load or remove discs.
- Do not load an empty 8 cm CD adaptor. It may damage the unit.
- Do not attach anything such as seals or sleeves to discs. It may damage the unit or the disc.
- If you drop a disc into the unit and the disc will not go into the slot correctly, consult your nearest Sony dealer.
- When transporting the unit, remove all discs from the unit.
- If you want to remove the disc played, open the front cover. The disc comes to the loading position. Remove the disc after the rotary table comes to a complete stop.

#### Tip

You can display the original Disc Memos instead of total number of tracks and total playing time (see “Labeling a disc” on page 17) to locate the disc easily when you start playing.

## Playing a disc

### — Normal Play/Shuffle Play



This system lets you play discs in different play modes.

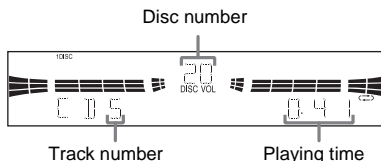

- 1 Press CD to switch the function to CD.**
- 2 When you want to specify the disc for 1 DISC, press DISC + or – (or turn DISC SELECT on the unit) until the desired disc number or Disc Memo appears.**
- 3 Press PLAY MODE repeatedly in stop mode until the mode you want appears in the display.**

Select	To play
ALL DISCS (Normal Play)	All discs in the disc tray continuously (up to 60 discs).
1 DISC (Normal Play)	The disc you have selected in original order.
ALBM (Normal Play)	All MP3 audio tracks in the album on the disc you have selected in original order. When playing a non-MP3 disc, Album Play performs the same operation as 1 DISC Play.
ALL DISCS SHUF (Shuffle Play)	The tracks on all discs in random order.
1 DISC SHUF (Shuffle Play)	The tracks on the disc you have selected in random order.
ALBM SHUF (Shuffle Play)	All MP3 audio tracks in the album on the disc you have selected in random order. When playing a non-MP3 disc, Album Shuffle Play performs the same operation as 1 DISC Shuffle Play.
PGM (Program Play)	The tracks on all discs in the order you want them to be played (see “Creating your own program” on page 16).

## 4 Press ◀▶.

### Other operations

To	Do this
Stop play	Press ■.
Pause	Press ■. Press again to resume play.
Select a track	During playback or pause, press ◀◀ or ▶▶ repeatedly.
Find a point in a track	Keep pressing ◀◀ or ▶▶ during playback and release it at the desired point.
Select an album of MP3	Press ALBM – or + repeatedly after step 2.
Select a disc	Press DISC + or – (or turn DISC SELECT on the unit to the right or to the left and release it when you reach the desired disc).

### Notes

- You cannot change the play mode during playback.
- Some time may be needed to start playback of discs recorded in complex configurations such as many layers.
- When the disc is inserted, the player reads all the audio tracks on that disc. If there are many albums or non-MP3 audio tracks on the disc, it may take a long time for play to begin or for the next MP3 audio track to start play.
- Do not save unnecessary albums or audio tracks other than MP3 ones in the disc to be used for MP3 listening. We recommend that you do not save other types of audio tracks or unnecessary albums on a disc that has MP3 audio tracks.
- An album that does not include an MP3 audio track is skipped.
- Maximum album number: 150 (including root album and empty albums)
- The maximum number of MP3 audio tracks and albums that can be contained on a single disc is 300.
- Playback is possible up to 8 levels.
- MP3 audio tracks are played back in the order that they are recorded on the disc.
- Depending on the encoding/writing software, recording device, or the recording media used at the time an MP3 audio track is recorded, you may encounter such problems as disabled playback, sound interruptions, and noise.
- When playing back an MP3 audio track, the playback elapsed time indication may differ from the actual time in the following cases.
  - When you play back a VBR (variable bit rate) MP3 audio track
  - When you perform Fast Forward or Rewind (Manual Search)

## Playing repeatedly

### — Repeat Play



You can play all the tracks or a single track on a disc.

**Press REPEAT repeatedly during playback until “REP” or “REP 1” appears.**

REP\*: For all the tracks on a disc up to five times (or endlessly for MP3 tracks when “SHUF” is displayed).

REP 1\*\*: For a single track only.

\* For all the tracks on all discs, press PLAY MODE repeatedly in stop mode to select “ALL DISCS”. However, you cannot select “ALL DISCS SHUF” and “REP” at the same time.

\*\* When you select “REP 1”, that track is repeated endlessly until Repeat Play is canceled.

To cancel Repeat Play

Press REPEAT repeatedly until both “REP” and “REP 1” disappear.

## Creating your own program

### — Program Play



You can make a program of up to 25 steps.

**1 Press CD to switch the function to CD.**

**2 Press PLAY MODE repeatedly in stop mode until “PGM” appears.**

**3 Press DISC + or – (or turn DISC SELECT on the unit) to select a disc.**

To program all the tracks on a disc at once, go to step 5 with “CDAL” displayed.

**4 Press ◀◀ or ▶▶ repeatedly until the desired track number appears.**

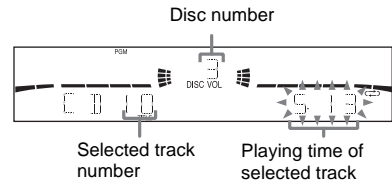

When programming an MP3, press ALBM – or + to select the album, then press ◀◀ or ▶▶ repeatedly until the desired track number appears.

**5 Press ENTER.**

The track is programmed.

The programmed track and corresponding step (playing order) appear.

**6 Program additional discs or tracks.**

To program	Repeat steps
Other discs	3 and 5
Other tracks on the same disc	4 and 5
Other tracks on other discs	3 to 5

**7 Press ◀▶.**

Program Play starts.



## Other operations

To	Do this
Cancel Program Play	Press <b>PLAY MODE</b> in stop mode repeatedly until “PGM” disappears.
Check the program	Press <b>◀▶</b> or <b>▶▶</b> repeatedly during Program Play.
Add tracks or discs to the end of the program	Perform step 6.
Clear a track or disc from the end	Press <b>CLEAR</b> in stop mode.
Erase the entire program	Press and hold <b>CLEAR</b> in stop mode.

### Tips

- The program you made remains after Program Play finishes. To play the same program again, press **CD**, then press **◀▶** in Program Play mode.
- “- - -” appears when the total program time exceeds 100 minutes, or when you select a disc track whose number is 21 or over or when you programmed an MP3 audio track.
- The programmed disc and track numbers remain until you erase them, so that the system plays only the existing disc and track numbers if you replace discs. However, the disc and track numbers that are not found in the system or on the disc are deleted from the program, and the rest of the program is played in the programmed order.

## Labeling a disc

### — Disc Memo

You can label up to 60 discs with titles of up to 20 characters. Whenever you load a labeled disc, the title appears in the display.

You can also label discs using an optional keyboard (see “Labeling titles through the keyboard” on page 31).

### Notes

- You cannot label a CD-TEXT disc.
- To ensure that Disc Memos are not erased from memory, have the system connected to a wall outlet at least once a day.
- You can label a disc only during Normal Play (when “1 DISC”, “ALL DISCS” or “ALBM” is displayed) in stop mode.

### 1 Press **CD** to switch the function to **CD**.

If “SHUF” or “PGM” appears, press **PLAY MODE** repeatedly until both disappear.

### 2 Press **DISC + or -** (or turn **DISC SELECT** on the unit) until the disc number you want to label appears.

### 3 Press **MENU**.

### 4 Press **◀▶** or **▶▶** repeatedly until “NAME IN” appears.

### 5 Press **ENTER**.

The cursor appears.

### 6 Turn **DISC SELECT** on the unit until the character you want appears.

You can input the following characters:

- Upper cases (A - Z)
- Numbers (0 - 9)
- Symbols (\* - / , + < > \_ = `)

### 7 Press **▶▶**.

The character you selected in step 6 stops flashing and the cursor shifts to the right.

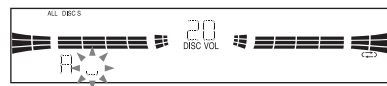

**8 Repeat steps 6 and 7 to complete the entire title.**

**If you make a mistake**

Press ◀◀ or ▶▶ until the character you want to change flashes, then repeat steps 6 and 7.

**To erase a character**

Press CLEAR while the character is flashing. You cannot insert characters.

**9 Press ENTER to complete the labeling procedure.**

To cancel labeling

Press MENU.

**Note**

The Disc Memo stores the number of the slot in which the disc was loaded. Re-enter the Disc Memo when loading a new disc into that slot.

**Tip**

When you replace a disc with a CD-TEXT disc, the disc title of the CD-TEXT disc is automatically restored. The Disc Memo of the CD-TEXT disc is no longer stored (disappears) when the disc is removed.

---

## Checking the Disc Memos

- 1 Press CD to switch the function to CD.**
- 2 Press MENU.**
- 3 Press ◀◀ or ▶▶ repeatedly until “NAME CHECK” appears, then press ENTER.**
- 4 Turn DISC SELECT on the unit to select the Disc Memos stored in the system memory between 01 and 60, then press MENU.**

To check the current Disc Memo

Press DISPLAY repeatedly until the Disc Memo appears in stop mode.

---

## Erasing a Disc Memo

- 1 Press CD to switch the function to CD.**  
If “SHUF” or “PGM” appears, press PLAY MODE repeatedly until both disappear.
- 2 Press MENU.**
- 3 Press ◀◀ or ▶▶ repeatedly until “NAME ERASE” appears, then press ENTER.**
- 4 Turn DISC SELECT on the unit to select the disc number with the Disc Memo you want to erase, then press ENTER.**

---

## Erasing all Disc Memos of all discs

- 1 Press CD to switch the function to CD.**  
If “SHUF” or “PGM” appears, press PLAY MODE repeatedly until both disappear.
- 2 Press MENU.**
- 3 Press ◀◀ or ▶▶ repeatedly until “ALL ERASE” appears, then press ENTER.**
- 4 Press ENTER again until “COMPLETE” appears.**

## Presetting radio stations

You can preset up to 20 FM stations and 10 AM stations. You can then tune in any of those stations simply by selecting the corresponding preset number.

### Automatic tuning preset

You can automatically tune in all of the stations that can be received in your area and then store the radio frequency of the desired stations.

- 1 Press **TUNER/BAND** repeatedly to select **"FM"** or **"AM"**.
- 2 Press and hold **TUNING –** or **+** until the frequency indication starts to change, then release it.

"AUTO" appears in the display.

Scanning stops automatically when a station is tuned in. At that time, "TUNED" and "ST" (for stereo program only) appear.

#### If "TUNED" does not appear and the scanning does not stop

Set the frequency of the desired radio station as described in steps 2 and 3 of "Manual tuning preset" (page 19).

- 3 Press **MENU**.
- 4 Press **PRESET –** or **+** repeatedly until **"MEMORY"** appears, then press **ENTER**.

The preset number flashes.

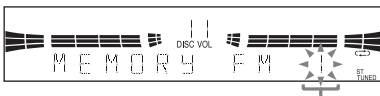

Preset number

- 5 Press **PRESET –** or **+** repeatedly to select the desired preset number.
- 6 Press **ENTER**.
- 7 Repeat steps 1 through 6 to preset other stations.

### Manual tuning preset

You can manually tune in and store the radio frequency of the desired stations.

- 1 Press **TUNER/BAND** repeatedly to select **"FM"** or **"AM"**.
- 2 Press **TUNING –** or **+** repeatedly to tune in the desired station.
- 3 Press **MENU**.
- 4 Press **PRESET –** or **+** repeatedly until **"MEMORY"** appears, then press **ENTER**.  
The preset number flashes.
- 5 Press **PRESET –** or **+** repeatedly to select the desired preset number.
- 6 Press **ENTER**.
- 7 Repeat steps 1 through 6 to preset other stations.

### Other Operations

To	Do this
Tune in a station with a weak signal	Follow the procedure described in "Manual tuning preset" (page 19).
Stop setting presets	Press <b>MENU</b> .
Set another station to the existing preset number	After step 4, press <b>◀</b> or <b>▶</b> repeatedly to select the preset number you want to store the station.

### To change the AM tuning interval

The AM tuning interval is factory-preset to 9 kHz (or 10 kHz for some areas). To change the AM tuning interval, tune in any AM station first, then turn off the system. While holding down **ENTER** on the unit, turn the system back on. When you change the interval, all the AM preset stations are erased. To reset the interval, repeat the same procedure.

## Note

You cannot change the AM tuning interval in the Power Saving Mode.

## Tips

- The preset stations are retained for about a day even if you disconnect the AC outlet or if a power failure occurs.
- You can label the preset stations (page 21).
- To improve the reception, adjust the supplied antennas or connect an external antenna.

# Listening to the radio

You can listen to a radio station either by selecting a preset station, or by manually tuning in the station.

---

## Listening to a preset station

### — *Preset Tuning*

Preset radio stations in the tuner's memory first (see "Presetting radio stations" on page 19).

- 1 Press TUNER/BAND repeatedly to select "FM" or "AM".**
- 2 Press PRESET – or + repeatedly to select the desired preset station.**

---

## Listening to non-preset radio station

### — *Manual Tuning*

- 1 Press TUNER/BAND repeatedly to select "FM" or "AM".**
- 2 Press TUNING – or + repeatedly to tune in the desired station.**

## Tips

- To improve broadcast reception, adjust the supplied antennas, or connect a commercially available external antenna.
- When an FM stereo program has static noise, press FM MODE/REPEAT on the unit repeatedly until "MONO" appears. There will be no stereo effect, but the reception will improve.
- By pressing and holding TUNING – or +, the frequency indication changes and scanning stops when the system tunes in a station (Automatic Tuning).
- To record the radio programs, see "Recording on a tape" on page 22.

## Labeling the preset stations

### — Station Name

You can label each preset station with up to 12 characters (Station Name).

- 1** Tune in the preset station you want to label (see “Listening to the radio” on page 20).
- 2** Follow the same procedures as from steps 3 to 9 of “Labeling a disc” on page 17.

To cancel labeling

Press MENU.

To erase the name

- 1** Tune in the station.
- 2** Press MENU.
- 3** Press PRESET – or + repeatedly to select “NAME IN”, then press ENTER.
- 4** Press CLEAR repeatedly to erase the name.
- 5** Press ENTER.

## Tape – Play

### Loading a tape

- 1** Press  $\blacktriangle$  PUSH on the tape deck.
- 2** Load a recorded/recordable tape into the cassette holder.

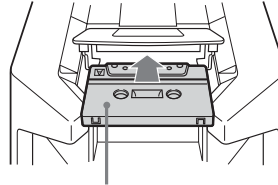

With the side you want to play/record facing towards you.

## Playing a tape

You can use TYPE I (normal) tape.

- 1 Press **TAPE** to switch the function to **TAPE**.
- 2 Press **PLAY MODE/DIRECTION** on the unit repeatedly to select “**↔**” to play one side of a tape, “**↔↔**” to play both sides, or “**↔↔↔**”\* to play both sides repeatedly.

\* The tape deck stops automatically after repeating the sequence five times.

- 3 Press **◀▶**.



Tape playback side

>>> appears for the front side, and <<< for the reverse side.

### Other operations

To	Do this
Play the reverse side	Press <b>◀▶</b> again during play.
Stop play	Press <b>■</b> .
Pause	Press <b>⏏</b> . Press again to resume play.
Fast-forward or rewind	Press <b>◀◀</b> or <b>▶▶</b> .
Remove a tape	Press <b>▲</b> <b>PUSH</b> on the tape deck in stop mode.

### Note

If the system stops during tape playback or recording due to a power failure or other reason, do not attempt to forcibly eject the tape as this may damage the heads. Wait until the power is restored, then be sure to press **I/⏏** to turn on the system before ejecting the tape.

## Tape – Recording

### Recording on a tape

You can record just the portions you like from a disc on a tape. You can also record a radio program.

### CD Synchro Recording

- 1 Load a recordable tape.
- 2 Press **TAPE**, then press **◀▶** repeatedly to select recording side.
- 3 Press **CD**.
- 4 Press **DISC +** or **-** (or turn **DISC SELECT** on the unit) to select the desired disc to record.
- 5 Press **CD SYNC** on the unit.  
Tape deck stands by for recording.
- 6 Press **PLAY MODE/DIRECTION** on the unit repeatedly until “**↔**” appears to record on one side or “**↔↔**” (or “**↔↔↔**”) to record on both sides.
- 7 Press **REC PAUSE/START** on the unit.  
Recording starts.

### Other operations

To	Do this
Stop recording	Press <b>■</b> .
Pause recording	Press <b>REC PAUSE/START</b> on the unit.

### To record a disc by specifying track order





You can record only your favorite disc tracks using Program Play. In step 4, perform steps 3 to 5 of “Creating your own program” on page 16. When programing, make sure the playing times for each side do not exceed the length of one side of the tape.

**Tip**

If you select both sides recording and the tape reaches the end of the front side part-way through a track, the entire track is recorded again from the beginning of the reverse side.

---

## Recording manually

- 1 Load a recordable tape.**
- 2 Press TAPE, then press  repeatedly to select recording side.**
- 3 Press the function button to select the desired source to record.**
  - CD: To record from this system's CD player.
  - TUNER: To record from this system's tuner.
  - VIDEO (MD): To record from the optional component connected to the VIDEO (MD) IN jacks.
- 4 Press REC PAUSE/START on the unit.**  
Tape deck stands by for recording.
- 5 Press PLAY MODE/DIRECTION on the unit repeatedly until "" appears to record on one side or "" (or "" or "" to record on both sides.**
- 6 Press REC PAUSE/START on the unit, then start playing the desired source to record.**

Recording starts.

## Other operations

To	Do this
Stop recording	Press  .
Pause recording	Press REC PAUSE/START on the unit.

**Tip**

If you select both sides recording and the tape reaches the end of the front side part-way through a track, the entire track is recorded again from the beginning of the reverse side.

## Sound Adjustment

### Adjusting the sound

#### Enjoying the powerful sound

##### — GROOVE/V-GROOVE

You can reinforce the bass and create a more powerful sound.

The GROOVE setting is ideal for music sources, and the V-GROOVE setting is ideal for video sources (movies, etc.).

##### **Press GROOVE.**

Each time you press the button, the display changes as follows:

GROOVE ON → V-GROOVE ON →

GROOVE OFF (off)

Tip

GROOVE is factory-set to on.

#### Selecting the surround effect

##### — SURROUND

##### **Press SURROUND.**

Each time you press the button, the display changes as follows:

SURROUND ON ↔ SURROUND OFF (off)

Note

When you select other sound effect, the surround effect will be canceled.

#### Selecting the sound effect

The preset music menu lets you select the sound characteristics according to the sound you are listening to.

##### **Press PRESET EQ repeatedly to select the preset you want.**

The preset name appears.

See the chart “Sound effect options”.

#### Sound effect options

“SUR” appears if you select an effect with surround effects.

Effect	
ROCK	Standard music sources
POP	
JAZZ	
GAME	PlayStation 1, 2 and other video game music sources

#### To cancel the effect

Press PRESET EQ repeatedly until “FLAT” appears.



## Enhancing video game sound

### — Game Sync

You can enjoy the sound effect of video games.

- 1 Connect a video game player (see “Hooking up optional components” on page 32).**
- 2 Press GAME.**

#### Note

The video game machine image may appear on the TV screen even if the system is turned off.

#### Tips

- The GAME EQ is automatically selected.
- These operations cannot be performed in the Power Saving Mode.
- If you press GAME while the system is off, the system turns on, the function switches to GAME and the equalizer also switches to the GAME (effect status).

## Mixing video game sound with other sound source

### — Game Mixing

- 1 Connect a video game player (see “Hooking up optional components” on page 32).**
- 2 Press the function button of the desired source.**
- 3 Press GAME MIXING.**

Each time you press the button the level of the game sound changes cyclically as follows:

MIXING LOW → MIXING MID →  
MIXING HIGH → MIXING OFF

#### Notes

- If you start recording while Game Mixing is activated, Game Mixing is canceled. To record the mixed sound, press GAME MIXING after step 4 of “Recording manually” (page 23), and then press REC PAUSE/START on the unit to start the recording.
- If you operate the CD controls on the unit (e.g. turn DISC SELECT, etc.) while Game Mixing is activated, the Game Mixing sound output may stop for a few seconds.

#### Tips

- “MIXING” appears while Game Mixing is activated.
- Once Game Mixing is activated, it will remain active while the power is on even if the source sound is changed.

## Falling asleep to music

### — Sleep Timer

You can set the system to turn off after a certain time, so that you can fall asleep to music.

#### Press SLEEP.

Each time you press the button, the minute display (the turn-off time) changes cyclically as follows:

SLEEP AUTO\* → SLEEP 90MIN → SLEEP 80MIN → SLEEP 70MIN → ... → SLEEP 10MIN → SLEEP OFF

\* The system automatically turns off in 100 minutes or after the current disc or tape finishes playing.

#### Other operations

To	Do this
Check the remaining time**	Press SLEEP once.
Change the time to turn off	Press SLEEP repeatedly to select the time you want.
Cancel the Sleep Timer Function	Press SLEEP repeatedly until "SLEEP OFF" appears.

\*\*You cannot check the remaining time if you select "SLEEP AUTO".

#### Tip

You can use the Sleep Timer, even if you have not set the clock.

## Waking up to music

### — Daily Timer

You can wake up to music at a preset time. Make sure you have set the clock (see "Setting the clock" on page 8).

#### 1 Prepare the sound source you want to play.

- CD: Load a disc. To start from a specific track, make a program (see "Creating your own program" on page 16).
- Tape: Load a tape with the side you want to play facing forward.
- Tuner: Tune in the preset radio station (see "Listening to the radio" on page 20).

#### 2 Press VOL + or – to adjust the volume.

#### 3 Press CLOCK/TIMER SET.

#### 4 Press ◀◀ or ▶▶ repeatedly to select "DAILY SET", then press ENTER.

"ON" appears and the hour indication flashes.

#### 5 Set the time to start playing.

Press ◀◀ or ▶▶ repeatedly to set the hour, then press ENTER.

The minute indication flashes.

Press ◀◀ or ▶▶ repeatedly to set the minute, then press ENTER.

#### 6 Set the time to stop playing following the same procedure as step 5.

#### 7 Press ◀◀ or ▶▶ repeatedly until the desired sound source appears.

Each time you press the button, the display changes cyclically as follows:



#### 8 Press ENTER.

The start time, the stop time, and the sound source appear in turn, before the original display returns.

#### 9 Press I/O to turn off the system.

## Other operations

To	Do this
Check the settings/ activate the timer	<ol style="list-style-type: none"><li>1 Press CLOCK/TIMER SELECT.</li><li>2 Press ◀◀ or ▶▶ repeatedly until "DAILY" appears, then press ENTER.</li></ol>
Change the setting	Start over from step 1.
Cancel the timer	<ol style="list-style-type: none"><li>1 Press CLOCK/TIMER SELECT.</li><li>2 Press ◀◀ or ▶▶ repeatedly until "TIMER OFF" appears, then press ENTER.</li></ol>

### Notes

- You cannot activate the Daily Timer and recording timer at the same time.
- If you use the Daily Timer and the Sleep timer at the same time, the Sleep Timer has priority.
- Do not operate the system from the time the system turns on until the play starts (about 15 seconds before the preset time).
- If the system is on about 15 seconds before the preset time, the Daily Timer will not be activated.
- You cannot use the optional component connected to VIDEO (MD) IN jacks as the sound source for Daily Timer.

## Timer recording radio programs

To timer record, you must first preset the radio station (see "Presetting radio stations" on page 19) and set the clock (see "Setting the clock" on page 8).

- 1 Tune in the preset radio station (see "Listening to a preset station" on page 20).**
- 2 Press CLOCK/TIMER SET.**
- 3 Press ◀◀ or ▶▶ repeatedly to select "REC SET", then press ENTER.**  
"ON" appears and the hour indication flashes.
- 4 Set the time to start recording.**  
Press ◀◀ or ▶▶ repeatedly to set the hour, then press ENTER.  
The minute indication flashes.  
Press ◀◀ or ▶▶ repeatedly to set the minute, then press ENTER.
- 5 Set the time to stop recording following the same procedure as step 4.**  
The timer recording settings and the desired station appear, then the original display returns.
- 6 Load a recordable tape.**
- 7 Press I/⏻ to turn off the system.**

## Other operations

To	Do this
Check the settings/ activate the timer	<p><b>1</b> Press CLOCK/TIMER SELECT.</p> <p><b>2</b> Press <b>◀◀</b> or <b>▶▶</b> repeatedly until “REC” appears, then press ENTER.</p> <p>The preset items appear in turn.</p>
Change the setting	Start over from step 1.
Cancel the timer	<p><b>1</b> Press CLOCK/TIMER SELECT.</p> <p><b>2</b> Press <b>◀◀</b> or <b>▶▶</b> repeatedly until “TIMER OFF” appears, then press ENTER.</p>

### Notes

- You cannot activate the Daily Timer and recording timer at the same time.
- If you use the recording timer and the Sleep Timer at the same time, the Sleep Timer has priority.
- If the system is on at the preset time, the timer-recording will not be activated.
- The volume is reduced to minimum during recording.

## Turning off the display

### — Power Saving Mode

The demonstration display (display window and buttons lighting and flashing even when the system power is off) and the clock display can be turned off to minimize the amount of power consumed during standby (Power Saving Mode).

**Press DISPLAY repeatedly while the system is off until the demonstration display and the clock display disappear.**

To cancel Power Saving Mode

Press DISPLAY while the system is off. Each time you press the button, the display switches cyclically as follows:

Demonstration display → Clock display\* → No display (Power Saving Mode)

\* “--:--” is displayed if you do not set the clock.

#### Note

You cannot perform the following operations in Power Saving Mode.

- setting the clock
- changing the AM tuning interval
- turning on the system by pressing the function buttons
- switching the VIDEO (MD) function

#### Tips

- I/⏻ indicator lights up even in the Power Saving Mode.
- The timer continues to operate in Power Saving Mode.

## Viewing information about the disc in the display

You can check the playing time and remaining time of the current track or that of the disc. When a CD-TEXT disc or a disc with MP3 audio tracks is loaded, you can also check the information recorded on disc, such as the titles.

### Checking the remaining time (CD/MP3)

**Press DISPLAY repeatedly during Normal Play.**

Each time you press the button, the display changes cyclically as follows:

Elapsed playing time of the current track →

Remaining time of the current track or

“--:--”<sup>\*1</sup> → Remaining time of the disc<sup>\*2</sup> or

“--:--”<sup>\*1</sup> → Track title (CD-TEXT disc or disc

with MP3 audio tracks<sup>\*3</sup> only) → Album

name<sup>\*1</sup> → Clock display → Effect status

<sup>\*1</sup> For disc with MP3 audio tracks

<sup>\*2</sup> “--:--” appears when “ALL DISCS” is displayed.

<sup>\*3</sup> When you play back a track with an ID3 tag ver. 1 (ver. 1.0 or 1.1), the ID3 tag appears. The ID3 tag displays only the track title information.

---

## Checking the total playing time and titles (CD/MP3)

### Press **DISPLAY** repeatedly in stop mode.

Each time you press the button, the display changes cyclically as follows:

TOC display\*<sup>1</sup> or total album number of the disc\*<sup>2</sup> or total number of the current album\*<sup>2</sup> → Disc Memo or Disc title\*<sup>3</sup> or album name\*<sup>2</sup> → Clock display → Effect status

\*<sup>1</sup> TOC = Table of Contents; displays current disc number, total number of tracks on the disc, and total playing time of the disc

\*<sup>2</sup> For discs with MP3 audio tracks, album titles may not be displayed depending on the play mode

\*<sup>3</sup> For disc with CD-TEXT

Depending on the disc, some CD-TEXT information may not appear.

---

## Checking the station name (TUNER)

### Press **DISPLAY** while listening to the radio.

Each time you press the button, the display changes cyclically as follows:

Preset number and frequency → Clock display → Effect status

## Changing the Power illuminator

### Press **ILLUMINATION** on the unit.

Each time you press the button, the Power illuminator around the volume knob changes cyclically as follows:

PATTERN 1 → PATTERN 2 → PATTERN 3 → PATTERN OFF

## Using an Optional Keyboard

### Setting the keyboard

You can use the Sony KB-10 keyboard (not supplied). In principle, you may use any IBM\*-compatible keyboard with a PS/2 interface.\*\* However, not all keyboards are guaranteed to work properly, so we recommend using the KB-10 keyboard.

\* IBM is the registered trademark of International Business Machines Corporation.

\*\* The power consumption must be 120 mA or less.

#### Note

Hum or noise may enter the AM radio sound depending on the operating environment.

### Connect the keyboard connector to the **KEYBOARD INPUT** jack.

You can connect the keyboard even when the system is turned on.

## Labeling titles through the keyboard

You can quickly enter or edit names using a keyboard. You can label a disc only during Normal Play (when “1 DISC”, “ALL DISCS” or “ALBM” is displayed) in stop mode.

Keyboard input is performed in insert mode.

### 1 Perform the following procedure depending on what you want to label.

To label	Do this
A disc	Switch the function to CD and select the desired disc.
A preset station	Switch the function to TUNER and select the desired preset radio station number.

### 2 Press MENU.

### 3 Press ◀◀ or ▶▶ repeatedly until “NAME IN” appears.

### 4 Press [Enter].

The text input screen appears and the cursor flashes.

### 5 Enter a title.

Besides letter keys, you can also use the keys shown in the following table.

### 6 Press [Enter].

“COMPLETE” appears for a few seconds and the title you labeled appears.

## Editing operations while labeling

To	Press
Cancel the operation	[Esc]
Move the cursor	[←] or [→]
Erase the character or space at the cursor position	[Delete]
Erase the character or space preceding the cursor	[Back Space]

## Operating the system through the keyboard

You can operate the system without using the buttons and controls on the unit or on the remote.

As the keyboard substitutes for the following functions	Press
CD PLAY	[F5]
CD PAUSE	[F6]
CD STOP	[F7]
DISC SELECT (DISC +)	[F8]
TUNER/BAND	[F9]
◀◀	[F10]
▶▶	[F11]
DISPLAY	[F12]

## Optional Components

### Hooking up optional components

To enhance your system, you can connect optional components. Refer to the operating instructions provided with each component.

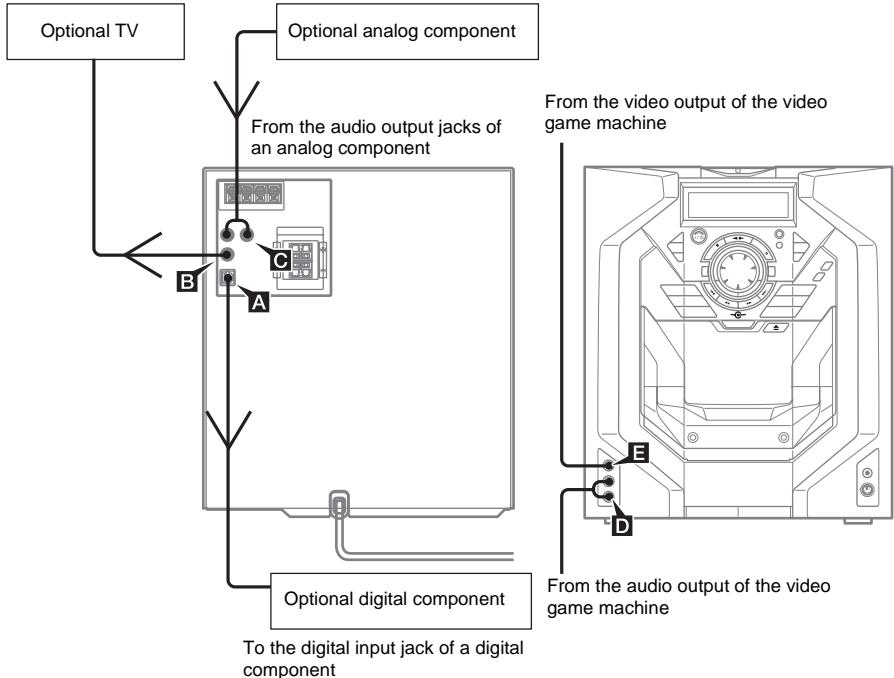

#### **A** OPTICAL OUT (CD) jack

Use a digital optical cable (square, not supplied) to connect an optional component (such as an MD deck) to this jack. You can then record digital audio from this system.

#### **B** VIDEO OUT jack

Use a video cable (not supplied) to connect the video input of TV to this jack. You can then output video to that component from the connected video game through this system.

#### **C** VIDEO (MD) IN jacks

Use audio cords (not supplied) to connect an optional analog component (MD deck or VCR, etc.) to these jacks. You can then record or listen to from the component through this system.

#### **D** AUDIO IN L/R jacks

Use audio cords (not supplied) to connect a video game machine to these jacks. You can then record or listen to analog audio from that component through this system.

#### **E** VIDEO IN jack

Use video cord (not supplied) to connect a video game machine to this jack. You can then output video to the connected TV from that component through this system.



## Listening to audio from a connected component

- 1 Connect the audio cords.**  
See “Hooking up optional components” on page 32.
- 2 Press VIDEO (MD) to select “VIDEO” or “MD”.**  
Start playing the connected component.

### Notes

- The function is factory-set to VIDEO.
- You cannot switch the function in Power Saving Mode.

### Tip

If you cannot select “MD” by pressing VIDEO (MD) repeatedly, turn off the system and then press VIDEO (MD) while holding down **■** on the unit. The function will change from “VIDEO” to “MD”, and “MD” will appear in the display. To change back to “VIDEO”, repeat the same procedure.

## Recording audio from a connected component

- 1 Connect the audio cords.**  
See “Hooking up optional components” on page 32.
- 2 Start recording manually.**  
See “Recording on a tape” on page 22.

## Recording on a connected component

- 1 Connect an optical cable.**  
See “Hooking up optional components” on page 32.
- 2 Start recording.**  
Refer to the operating instructions provided with connected component.

## Troubleshooting

### Problems and remedies

Should you encounter a problem with your system, do the following:

- 1 Make sure the power cord and speaker cords are correctly and firmly connected.
- 2 Find your problem in the troubleshooting checklist below and take the indicated corrective action.

If the problem persists after doing all of the above, consult your nearest Sony dealer.

In case of repairing, please bring the entire system set (except for the speaker) to the service station.

#### General

---

**The display starts flashing as soon as you plug in the power cord even though you have not turned on the system (see step 3 of “Hooking up the system” on page 7).**

- Press DISPLAY twice when the system is turned off. The demonstration disappears.

---

**“-- --” appears in the display.**

- A power interruption has occurred. Set the clock (page 8) and timer settings (pages 26 and 27) again.

---

**The clock setting/radio presetting/timer is canceled.**

- The power cord is disconnected or a power failure occurs longer than half a day.

Redo the following:

- “Setting the clock” on page 8
- “Presetting radio stations” on page 19

If you have set the timer, also redo “Waking up to music” on page 26 and “Timer recording radio programs” on page 27.

---

**There is no sound.**

- Press VOL + (or turn VOLUME clockwise on the unit).
- Make sure the headphones are not connected.
- Insert only the stripped portion of the speaker cord into the SPEAKER jack. Inserting the vinyl portion of the speaker cord will obstruct the speaker connections.
- There is no audio output during timer recording.

---

**Sound comes from one channel, or unbalanced left and right volume.**

- Place the speakers as symmetrically as possible.
- Connect the supplied speakers.

---

**There is severe hum or noise.**

- Move the system away from the source of noise.
- Connect the system to a different wall outlet.
- Install a noise filter (commercially available) to the mains line.

---

**The sound from the connected source is distorted when VIDEO function is selected.**

- Select the MD function. If “VIDEO” appears in the display when you press VIDEO (MD), switch the function to MD (see “Listening to audio from a connected component” on page 33).

---

**The timer cannot be set.**

- Set the clock again (page 8).

---

**The timer does not function.**

- Press CLOCK/TIMER SELECT to set the timer and light up “DAILY” or “REC” in the display (pages 26 and 27).
- Check the timer setting and set the correct time (pages 26 and 27).
- Cancel the Sleep Timer Function (page 26).
- Make sure the clock is correctly set.

---

**The color on the TV screen is irregular.**

- Turn off the TV set once, then turn it on after 15 to 30 minutes. If the color irregularity still persists, move the speakers farther away from the TV set.

---

**The remote does not function.**

- Remove the obstacle.
- Move the remote closer to the system.
- Point the remote at the system’s sensor.
- The batteries have run down. Replace the batteries (size AA/R6).

---

## Speakers

---

**Sound comes from only one channel, or the left and right volumes are unbalanced.**

- Connect the speaker cords properly (page 7).
- Place the speakers as symmetrically as possible.
- Connect only one of the supplied speakers to each set of speaker terminals.
- Connect the supplied speakers.

---

**Sound lacks bass.**

- Check that the speaker’s + and – jacks are connected correctly.
-

**Play does not start.**

- Close the front cover.
- Check if the disc is correctly loaded in the slot.
- Wipe the disc clean (page 38).
- Replace the disc.
- Place the disc that this system can play.
- Place the disc in the tray with the label side facing right.
- Remove the disc and wipe away the moisture on the disc, then leave the system turned on for a few hours until the moisture evaporates.
- Press ◀▶ to start play.

**Play does not start from the first track.**

- Press PLAY MODE repeatedly until both “PGM” and “SHUF” disappear to return to Normal Play.

**MP3 audio track cannot be played back.**

- Recording was not performed according to the ISO 9660 level 1 or level 2 format, or Joliet in the expansion format.
- The MP3 audio track does not have the extension “.MP3”.
- The data is not stored in MP3 format.
- Discs containing tracks other than MPEG1, 2 Audio Layer-3 files cannot be played.

**MP3 audio tracks take longer to play back than others.**

- After the system reads all tracks on the discs, playback may take more time than usual if:
  - the number of albums or tracks on the disc is very large.
  - the album and track organization structure is very complex.

**The album title, track title and ID3 tag do not appear correctly.**

- Use a disc that conforms with ISO 9660 level 1, level 2, or Joliet in the expansion format.
- The disc ID3 tag is not ver. 1 (ver. 1.0 or 1.1).

**The sound skips.**

- Wipe the disc clean (page 38).
- Replace the disc.
- Try moving the system to a place without vibration (e.g., on top of a stable stand).
- Try moving the speakers away from the system, or placing them on separate stands. When you listen to a track with bass sounds at high volume, the speaker vibration may cause the sound to skip.

**Severe hum or noise/stations cannot be received.**

- Set the proper band and frequency (page 19).
- Connect the antenna properly (page 7).
- Find a place and an orientation that provide good reception, then set up the antenna again. If you cannot obtain good reception, we recommend you connect a commercially available external antenna.
- The supplied FM lead antenna receives signals along its entire length, so make sure you extend it fully.
- Locate the antennas as far away from the speaker cords as possible.
- Consult your nearest Sony dealer if the supplied AM antenna has come off the plastic stand.
- Try turning off surrounding electrical equipment.

**A stereo FM program cannot be received in stereo.**

- Press FM MODE/REPEAT on the unit until “ST” appears in the display.

**The tape does not record.**

- No cassette is loaded. Load a cassette.
- The tab has been removed from the cassette. Cover the broken tab with adhesive tape (page 39).
- The tape has wound to the end.

**The tape does not record or play, or there is a decrease in sound level.**

- The heads are dirty. Clean them (page 39).
- The record/playback heads are magnetised. Demagnetise them (page 39).

**The tape does not erase completely.**

- The record/playback heads are magnetised. Demagnetise them (page 39).

**There is excessive wow or flutter, or the sound drops out.**

- The capstans or pinch rollers in the tape deck are dirty. Clean them using a cleaning cassette.

**Noise increases or the high frequencies are erased.**

- The record/playback heads are magnetised. Demagnetise them (page 39).

---

After pressing ◀▶ or ▲ PUSH on the tape deck, there is a mechanical noise, "EJECT" appears, and the system enters standby mode automatically.

- The tape was not loaded correctly.
- 

## Transmitter

---

### There is no sound.

- Check the connection of the optional component.
  - Check that the optional component is turned on.
  - Turn up the volume on the connected optional component, if the transmitter is connected to the headphones jack.
  - Change the radio frequency using the CHANNEL selector on the transmitter, then press WIRELESS again.
  - If you connect the transmitter to the analog out jacks of an audio reproducer, make sure that the NOISE FILTER switch is set to OFF.
  - Make sure that the NOISE FILTER switch is set to either ON or OFF (If the switch gets stuck between ON and OFF, the sound will be cut off).
- 

### There is severe hum or noise.

- If the transmitter is connected to the headphones jack, turn down the volume of the connected optional component. If the connected optional component has the BASS BOOST or MEGA BASS function, set these function to OFF.
  - If the connected optional component has a LINE OUT jacks, connect its LINE OUT jacks.
  - Change the radio frequency with the CHANNEL selector on the transmitter then press WIRELESS again.
  - If you connect the transmitter to the analog out jacks of an audio reproducer, make sure that the NOISE FILTER switch is set to OFF.
- 

## Optional components

---

### There is no sound.

- Refer to General item "The clock setting/radio presetting/timer is canceled." (page 34) and check the condition of the system.
  - Connect the component properly (page 32) while checking:
    - if the cords are connected properly.
    - if the cord plugs are firmly inserted all the way.
  - Turn on the connected component.
  - Refer to the operating instructions supplied with the connected component and start playing.
  - Press VIDEO (MD) to select "VIDEO" or "MD" (page 33).
- 

### The sound is distorted.

- Set the volume of the connected component lower.
-

If the system still does not operate properly after performing the above measures, reset the system as follows:

- 1 Disconnect the AC outlet.
- 2 Reconnect the AC outlet.
- 3 Press I/⏻ to turn on the system.
- 4 Press ■, CLEAR and DISPLAY on the unit at the same time.

The system is reset to the factory settings. You should set the settings you made, such as the preset stations, clock, and timer.

## Messages

One of the following messages may appear or flash in the display during operation.

---

### NO DISC

There is no disc in the disc slot.

---

### OVER

You have reached the end of the disc while pressing ►► during playback or pause.

---

### PROTECT

Press I/⏻ (power) to turn off the system. Turn on the system again after a while.

If the problem persists after doing above, consult your nearest Sony dealer.

---

### PUSH STOP

You pressed PLAY MODE/DIRECTION during play.

---

### STEP FULL

You tried to program 26 or more tracks (steps).

---

### Precautions

#### On operating voltage

Before operating the system, check that the operating voltage of your system is identical with the voltage of your local power supply.

#### On safety

- The unit is not disconnected from the AC power source (mains) as long as it is connected to the wall outlet, even if the unit itself has been turned off.
- Unplug the system from the wall outlet (mains) if it is not to be used for an extended period of time. To disconnect the power cord (mains lead), pull it out by the plug. Never pull the cord itself.
- Should any solid object or liquid fall into the system, unplug the system and have it checked by qualified personnel before operating it any further.
- AC power cord must be changed only at the qualified service shop.

#### On placement

- Do not place the system in an inclined position.
- Do not place the system in locations where it is;
  - Extremely hot or cold
  - Dusty or dirty
  - Very humid
  - Subject to vibrations
  - Subject to direct sunlight.
- Use caution when placing the unit or speakers on surfaces that have been specially treated (with wax, oil, polish, etc.) as staining or discoloration of the surface may result.

#### On heat buildup

- Although the system heats up during operation, this is not a malfunction.
- Place the system in a location with adequate ventilation to prevent heat build-up in the system.
- If you continuously use this system at a high volume, the cabinet temperature of the top, side and bottom rises considerably. To avoid burning yourself, do not touch the cabinet.
- To prevent a malfunction, do not cover the ventilation hole for the cooling fan.

#### On operation

- If the system is brought directly from a cold to a warm location, or is placed in a very damp room, moisture may condense on the lens inside the CD player. Should this occur, the system will not operate properly. Remove the disc and leave the system turned on for about an hour until the moisture evaporates.
- When you move the system, take out any disc.

If you have any questions or problems concerning your system, please consult your nearest Sony dealer.

#### On the speaker system

This speaker system is not magnetically shielded. Therefore, leave a space of 5 to 10 cm or more when placing the speakers next to a television.

#### Notes on discs

- Before playing, clean the disc with a cleaning cloth. Wipe the disc from the center out.
- Do not use solvents such as benzene, thinner, commercially available cleaners or anti-static spray intended for vinyl LPs.
- Do not expose the disc to direct sunlight or heat sources such as hot air ducts, nor leave it in a car parked in direct sunlight.
- Do not use discs encircled with a protection ring. This may cause a malfunction to the system.
- When using discs that have glue or similar tacky substance on the label side of the disc or that used a special ink when the label was printed, there is a chance that the disc or label may become attached to parts inside this unit. When this occurs, it may not be possible to remove the disc, and may also cause this unit to malfunction. Be sure to check that the label side of the disc is not sticky before using.

The following types of disc should not be used:

- Rental or used discs with attached seals where the glue extends beyond the seal. The perimeter of the seal on the disc is tacky.
- Discs that have labels printed using a special ink that feels tacky when touched.
- Discs with non-standard shapes (e.g., heart, square, star) cannot be played on this unit. Attempting to do so may damage the unit. Do not use such discs.

#### Cleaning the cabinet

Clean the cabinet, panel and controls with a soft cloth slightly moistened with mild detergent solution. Do not use any type of abrasive pad, scouring powder or solvent such as thinner, benzene or alcohol.

To save a tape permanently

To prevent a tape from being accidentally recorded over, break off the cassette tab from side A or B as illustrated.

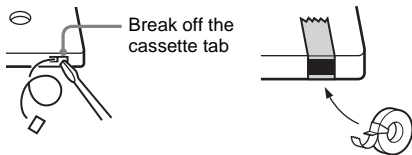

If you later want to reuse the tape for recording, cover the broken tab with adhesive tape.

Before placing a cassette in the tape deck

Take up any slack in the tape. Otherwise, the tape may get entangled in the parts of the tape deck and become damaged.

When using a tape longer than 90 minutes

The tape is very elastic. Do not change the tape operations such as play, stop, and fast-winding frequently. The tape may get entangled in the tape deck.

Cleaning the tape heads

Clean the tape heads after every 10 hours of use.

Be sure to clean the tape heads before you start an important recording or after playing an old tape.

Use a separately sold dry-type or wet-type cleaning cassette. For details, refer to the instructions of the cleaning cassette.

Demagnetising the tape heads

Demagnetise the tape heads and the metal parts that have contact with the tape after every 20 to 30 hours of use with a separately sold demagnetising cassette. For details, refer to the instructions of the demagnetising cassette.

## Specifications

Main Unit  
(HCD-GSX100W/GSX75)

**Amplifier section**

**MHC-GSX100W/GSX75**

**For the U.S. model**

### AUDIO POWER SPECIFICATIONS

POWER OUTPUT AND TOTAL HARMONIC DISTORTION:

With 6-ohm loads, both channels driven, from 120 – 10,000 Hz; rated 200 watts (for GSX100W), 150 watts (for GSX75) per channel minimum RMS power, with no more than 10% total harmonic distortion from 250 milliwatts to rated output.

#### MHC-GSX100W

Continuous RMS power output (reference):

200 + 200 W  
(6 ohms at 1 kHz, 10%  
THD)

Total harmonic distortion less than 0.09% (6 ohms at 1 kHz, 125 W)

#### MHC-GSX75

Continuous RMS power output (reference):

150 + 150 W  
(6 ohms at 1 kHz, 10%  
THD)

Total harmonic distortion less than 0.09% (6 ohms at 1 kHz, 70 W)

Inputs

VIDEO (MD) IN (phono jacks):

voltage 250/450 mV,  
impedance 47 kilohms

AUDIO IN (phono jacks): 450 mV, impedance 47 kilohms

Outputs

VIDEO OUT (phono jacks):

max. output level 1Vp-p,  
unbalanced, Sync  
negative, load impedance  
75 ohms

PHONES (stereo phone jack):

accepts headphones of  
8 ohms or more

SPEAKER:

accepts impedance of 6 to  
16 ohms

## CD player section

System	Compact disc and digital audio system
Laser	Semiconductor laser (CD: $\lambda=770 - 810$ nm) Emission duration: continuous
Frequency response	CD: 20 Hz – 20 kHz ( $\pm 0.5$ dB)
Signal-to-noise ratio	More than 90 dB
Dynamic range	More than 90 dB
OPTICAL OUT (CD)	
(Square edge connector jack, rear panel)	
Wavelength	660 nm
Output level	-18 dBm

## Tape deck section

Recording system	4-track 2-channel stereo
Frequency response	40 – 13,000 Hz ( $\pm 3$ dB), using Sony TYPE I cassettes
Wow and flutter	$\pm 0.15\%$ W. Peak (IEC) 0.1% W. RMS (NAB) $\pm 0.2\%$ W. Peak (DIN)

## Tuner section

FM stereo, FM/AM superheterodyne tuner

### FM tuner section

Tuning range	
North American model:	87.5 – 108.0 MHz (100-kHz step)
Australian model:	87.5 – 108.0 MHz (50-kHz step)
Antenna	FM lead antenna
Antenna terminals	75 ohms unbalanced
Intermediate frequency	10.7 MHz
AM tuner section	
Tuning range	
North American model:	530 – 1,710 kHz (with the tuning interval set at 10 kHz) 531 – 1,710 kHz (with the tuning interval set at 9 kHz)
Australian model:	531 – 1,602 kHz (with the tuning interval set at 9 kHz) 530 – 1,710 kHz (with the tuning interval set at 10 kHz)
Antenna	AM loop antenna, external antenna terminal
Intermediate frequency	450 kHz

## Speaker

### SS-GSX100 for MHC-GSX100W

Speaker system	3-way, bass-reflex type magnetically shielded type
Speaker units	
Woofer:	15 cm, cone type
Tweeter:	5 cm, cone type
Super Tweeter:	2 cm, dome type
Nominal impedance	6 ohms

### SS-GSX75 for MHC-GSX75

Speaker system	3-way, bass-reflex type
Speaker units	
Woofer:	13.5 cm, cone type
Tweeter:	5 cm, cone type
Super Tweeter:	2 cm, dome type
Nominal impedance	6 ohms

## Transmitter

### TMR-GSX100 for MHC-GSX100W

Carrier frequency	913.5 – 914.5 MHz
Channel	
CHANNEL1:	913.5 MHz
CHANNEL2:	914.0 MHz
CHANNEL3:	914.5 MHz
Modulation	FM stereo
Power source	DC 9 V: supplied AC power adaptor (AC-GSX100)
Audio input	phono jacks/stereo mini jack

## General

Power requirements	
North American model:	120 V AC, 60 Hz
Australian model:	230 – 240 V AC, 50/60 Hz
Power consumption	
MHC-GSX100W:	170 W
MHC-GSX75:	150 W
Dimensions (w/h/d) incl. projecting parts and controls	
Amplifier/Tuner/Tape/CD section:	Approx. 280 × 326 × 490 mm
Speakers	
MHC-GSX100W:	Approx. 255 × 326 × 310 mm
MHC-GSX75:	Approx. 225 × 326 × 272 mm
Transmitter (MHC-GSX100W only)	Approx. 136 × 100 × 103 mm



Supplied accessories

- Remote (1)
- size AA (R6) batteries (2)
- AM loop antenna (1)
- FM lead antenna (1)
- Transmitter  
(MHC-GSX100W only)
- (1)
- AC adaptor  
(MHC-GSX100W only)
- (1)
- Connecting cord phono  
plug-stereo miniplug (1m)  
(MHC-GSX100W only)
- (1)

Design and specifications are subject to change  
without notice.

# List of button locations and reference pages

## How to use this page

Use this page to find the location of buttons and other parts of the system that are mentioned in the text.

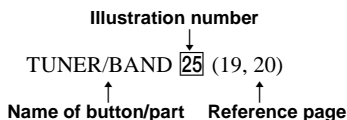

## Main unit

For MHC-GSX100W

### ALPHABETICAL ORDER

#### A - H

ALBM + **12** (15, 16)  
 ALBM - **28** (15, 16)  
 AUDIO IN jack **20**  
 CD **27** (14, 16, 17, 22)  
 CD SYNC **10** (22)  
 CLEAR **29** (17, 18, 21, 37)  
 DISC SELECT **22** (13, 14, 16, 17, 22)  
 DISPLAY **7** (18, 29, 37)  
 Display window **2**  
 ENTER **30** (8, 16, 17, 19, 21, 26, 27)  
 FM MODE/REPEAT **9** (20)  
 GAME **15** (25)  
 GAME MIXING **11** (25)

#### I - Z

ILLUMINATION **6** (30)  
 KEYBOARD INPUT jack **19**  
 MENU **31** (17, 19, 21, 31)  
 PHONES jack **18**  
 PLAY MODE/DIRECTION **8** (14, 16, 22)  
 POWER ILLUMINATOR **23** (30)  
 Remote sensor **32**  
 TAPE **13** (22)  
 Tape deck **3**  
 TUNER/BAND **26** (19, 20)  
 VIDEO (MD) **14** (33)  
 VIDEO IN jack **21**  
 VOLUME **24** (26)  
 WIRELESS **25** (11)

### BUTTON DESCRIPTIONS

I/⏻ (power) **1** (8, 22, 26, 27, 37)  
 ▲ PUSH (tape deck) **3** (21, 22)  
 ◀▶ (play) **4** (15, 16, 22)  
 || (pause) **4** (15, 22)  
 ■ (stop) **4** (15, 22, 33, 37)  
 REC PAUSE/START **5** (23, 25)  
 ▲ PUSH (front cover) **16** (13)  
 ◀◀ (rewind) **17** (15, 22)  
 ▶▶ (fast forward) **17** (15, 17, 22)  
 ◀◀ (go back) **17** (8, 15, 16, 17, 19, 26, 27, 31)  
 ▶▶ (go forward) **17** (8, 15, 16, 17, 19, 26, 27, 31)

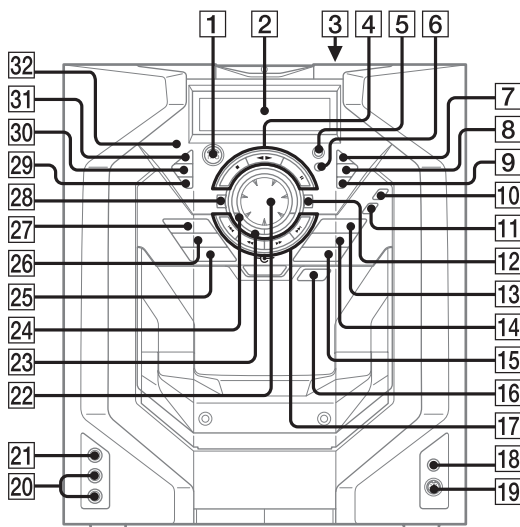

**ALPHABETICAL ORDER**

**A - H**

- ALBM + **12** (15, 16)
- ALBM - **27** (15, 16)
- AUDIO IN jack **20**
- CD **26** (14, 16, 17, 22)
- CD SYNC **10** (22)
- CLEAR **28** (17, 18, 21, 37)
- DISC SELECT **22** (13, 14, 16, 17, 22)
- DISPLAY **7** (18, 29, 37)
- Display window **2**
- ENTER **29** (8, 16, 17, 19, 21, 26, 27)
- FM MODE/REPEAT **9** (20)
- GAME **15** (25)
- GAME MIXING **11** (25)

**I - Z**

- ILLUMINATION **6** (30)
- KEYBOARD INPUT jack **19**
- MENU **30** (17, 19, 21, 31)
- PHONES jack **18**
- PLAY MODE/DIRECTION **8** (14, 16, 22)
- POWER ILLUMINATOR **23** (30)
- Remote sensor **31**
- TAPE **13** (22)
- Tape deck **3**
- TUNER/BAND **25** (19, 20)
- VIDEO (MD) **14** (33)
- VIDEO IN jack **21**
- VOLUME **24** (26)

**BUTTON DESCRIPTIONS**

- I/⏻ (power) **1** (8, 22, 26, 27, 37)
- ▲ PUSH (tape deck) **3** (21, 22)
- ◀▶ (play) **4** (15, 16, 22)
- ⏸ (pause) **4** (15, 22)
- (stop) **4** (15, 22, 33, 37)
- REC PAUSE/START **5** (23, 25)
- ▲ PUSH (front cover) **16** (13)
- ◀◀ (rewind) **17** (15, 22)
- ▶▶ (fast forward) **17** (15, 17, 22)
- ◀◀ (go back) **17** (8, 15, 16, 17, 19, 26, 27, 31)
- ▶▶ (go forward) **17** (8, 15, 16, 17, 19, 26, 27, 31)

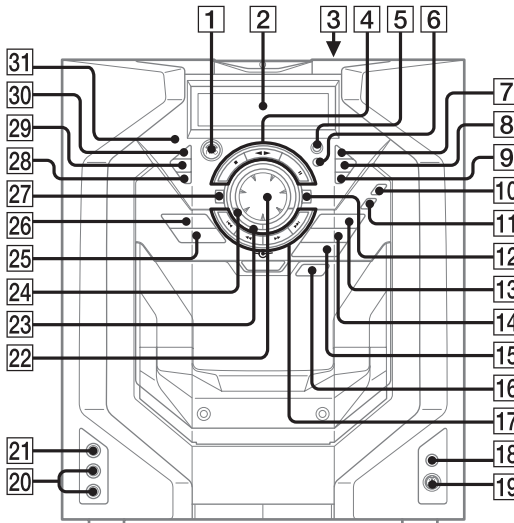

# Remote control

For MHC-GSX100W/GSX75

## ALPHABETICAL ORDER

### A - Q

- ALBM +/- **14** **21** (15, 16)
- CD **29** (14, 16, 17, 22)
- CLEAR **10** (17, 18, 21)
- CLOCK/TIMER SELECT **2**  
(27, 28)
- CLOCK/TIMER SET **3** (8, 26,  
27)
- DISC +/- **15** **20** (13, 14, 16, 17,  
22)
- DISPLAY **11** (18, 29)
- ENTER **25** (8, 16, 17, 19, 21, 26,  
27)
- GAME **27** (25)
- GAME MIXING **9** (25)
- GROOVE **17** (24)
- MENU **26** (17, 19, 21, 31)
- PLAY MODE **6** (14, 16)
- PRESET +/- **12** **23** (19, 20, 21)
- PRESET EQ **16** (24)

### R - Z

- REPEAT **8** (16)
- SLEEP **1** (26)
- SURROUND **19** (24)
- TAPE **5** (22)
- TUNER/BAND **30** (19, 20)
- TUNING +/- **13** **22** (19, 20)
- VIDEO (MD) **28** (33)
- VOL +/- **18** (26)
- WIRELESS\* **7** (11)

## BUTTON DESCRIPTIONS

- I/⏻ (power) **4** (8, 22, 26, 27,  
37)
- ◀▶ (play) **24** (15, 16, 22)
- ⏸ (pause) **24** (15, 22)
- (stop) **24** (15, 22)
- ◀◀ (go back) **23** (8, 15, 16, 17,  
19, 26, 27, 31)
- ◀◀ (rewind) **22** (15, 22)
- ▶▶ (fast forward) **13** (15, 17, 22)
- ▶▶ (go forward) **12** (8, 15, 16,  
17, 19, 26, 27, 31)

Notes for the supplied remote

\* The WIRELESS button is not available for MHC-GSX75.

