

DIGITAL RADIO  
DAB/FM

Operating Instructions

DAB DAB+

R-D-S



©2015 Sony Corporation Printed in China

XDR-P1DBP

# Getting Started

## 1 Charge the radio from a wall outlet using the micro USB cable (supplied).

Charge the built-in lithium-ion rechargeable battery before using the radio for the first time. The battery will be fully charged ("100%") in about 4 hours.

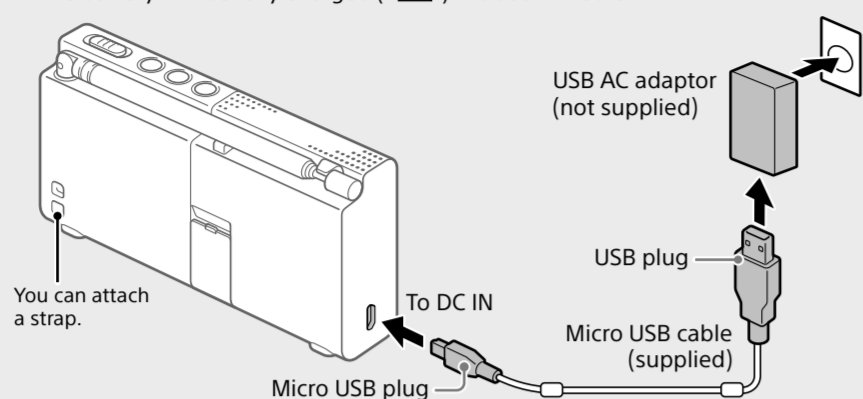

### Notes

- When using a commercially available USB AC adaptor, be sure to use an adaptor with a power output of 0.5 A or more. Charging with other types of adaptors is not covered by the warranty.
- If you charge the battery while listening to the radio, there may be noise interference in the radio.

### Tip

You can also charge the battery by connecting the USB plug to some USB devices, such as a PC, USB battery charger, etc.

## 2 Extend the antenna.

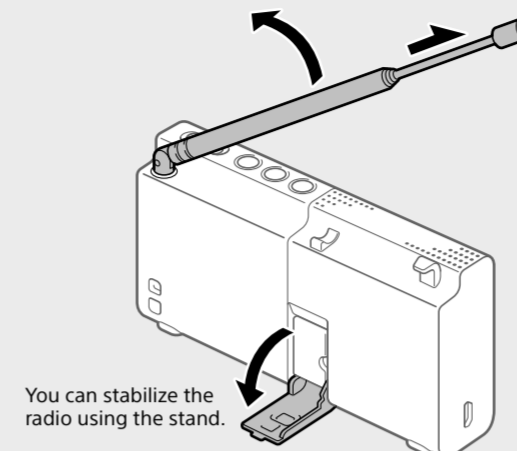

## 3 Turn on the radio.

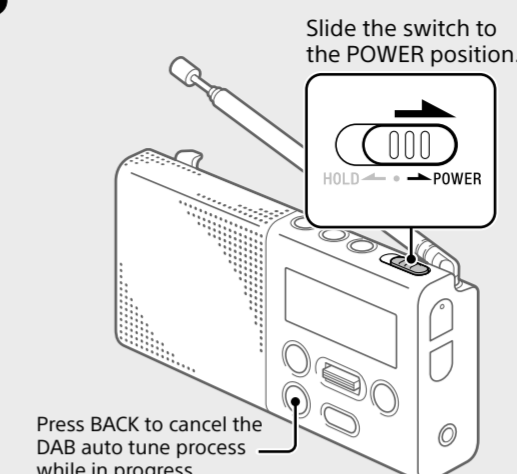

If it is the first time the radio is turned on, DAB auto tune is performed automatically.

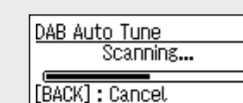

After DAB auto tune is completed, the radio receives the first station in the DAB station list stored by DAB auto tune.

### Tips

- To perform DAB auto tune again later, see "To make a new DAB station list" below.
- The backlight will turn off if no operation is performed for about 30 seconds to minimize power consumption.

# Listening to the Radio

## 1 Turn on the radio.

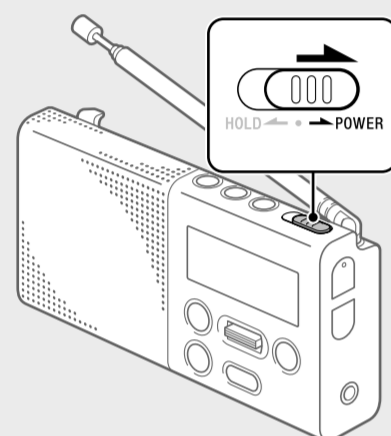

## 2 Press DAB/FM repeatedly to select DAB or FM.

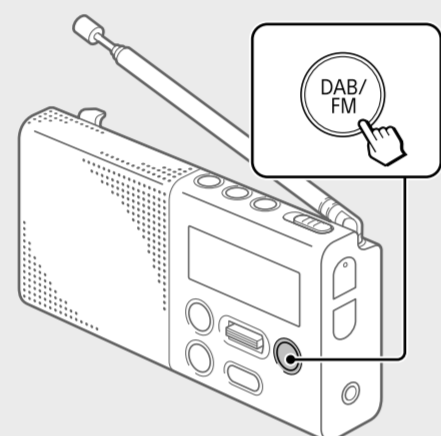

## 3 Select a desired station or service.

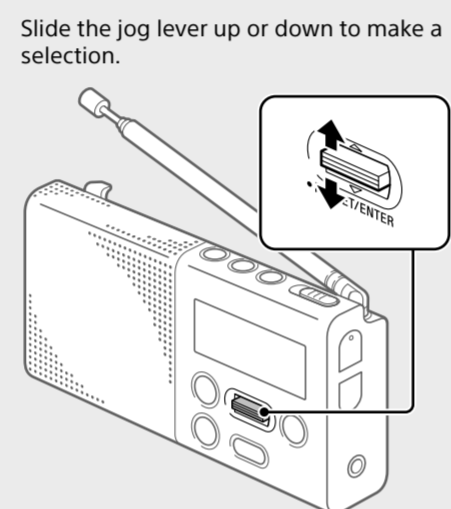

### DAB

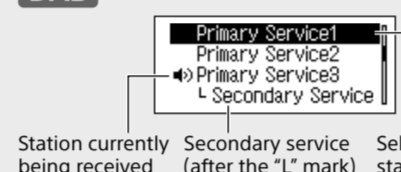

Press the jog lever.



See "Setup Menu Options" for manual tuning.

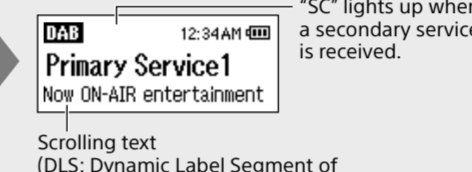

### FM

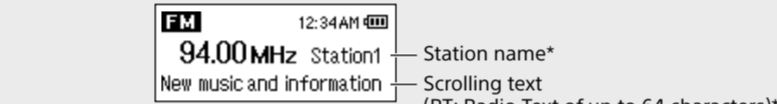

\* Displayed only when RDS data has been received.

### Tips on receiving FM station names

- FM station names will be received and stored in the radio while you are listening to the broadcasts.
- FM station names may not be transmitted, depending on the station.

## To make a new DAB station list

If you have moved to another region, perform the DAB auto tune again. Select DAB, then press AUTO TUNE.

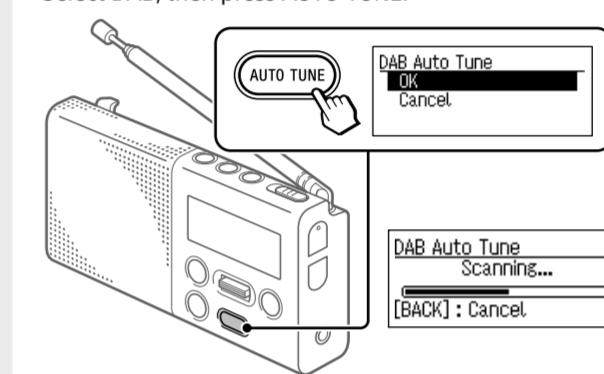

Select "OK" to start the DAB auto tune process.

The radio receives the first station in the new station list.

### Notes

- The currently stored station list will be cleared once the DAB auto tune process has started.
- When the setup menu is displayed, DAB auto tune is not performed even when AUTO TUNE is pressed.

## Assigning stations to the Favourite buttons

Assign your favourite stations to the 3 favourite buttons. You can assign up to 3 stations (DAB and/or FM).

## 1 Tune to the station you want.

Follow steps 1 to 3 in "Listening to the Radio" above.

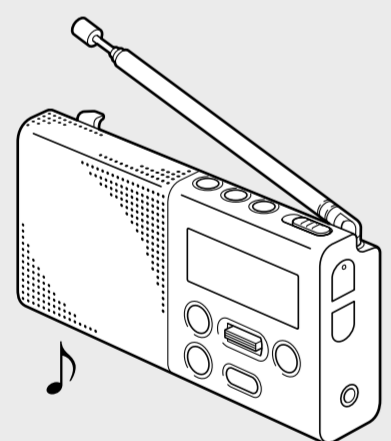

## 2 Press and hold the desired favourite button (1 - 3) until "Station saved to favourite x." appears on the display.

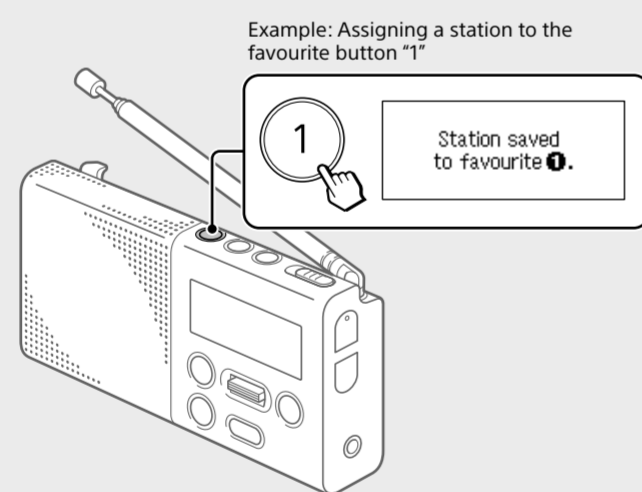

Example: Assigning a station to the favourite button "1"

## 3 Repeat steps 1 and 2 to assign another station to another favourite button.

### Changing button assignment

- Tune to a new station.
- Press and hold the favourite button you want to change until "Station saved to favourite x." appears on the display. The previously assigned station on the selected button will be replaced by the new one.

### Tip

The button assignment information remains in the radio's memory even after a DAB auto tune is performed.

## Listening to an assigned station

Press the desired favourite button (1 - 3).

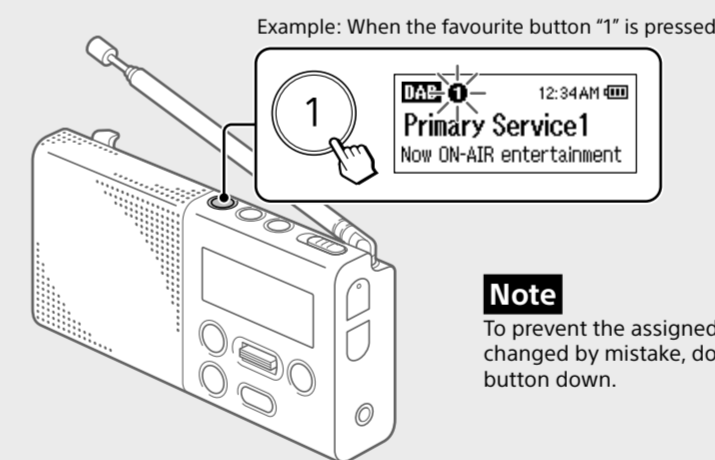

### Note

To prevent the assigned station from being changed by mistake, do not hold the favourite button down.

## To search FM stations

You can search receivable FM stations in 0.05 MHz steps. Select FM, then press AUTO TUNE.

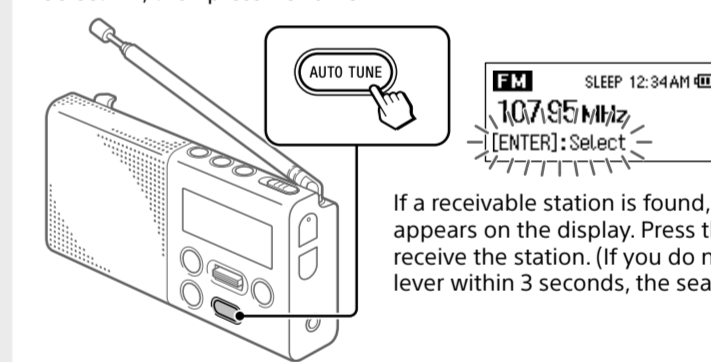

If a receivable station is found, "[ENTER]:Select" appears on the display. Press the jog lever to receive the station. (If you do not press the jog lever within 3 seconds, the search will restart.)

### Tips

- You can also search FM stations by sliding and holding the jog lever up or down after selecting FM.
- Press BACK to stop searching FM stations.

## Presetting stations to the preset list

You can preset up to 10 DAB and 10 FM stations.

## 1 Tune to the station you want.

Follow steps 1 to 3 in "Listening to the Radio" above.

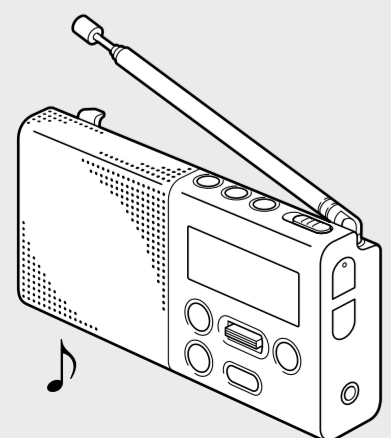

## 2 Press and hold the jog lever until "Save Preset" appears on the display.

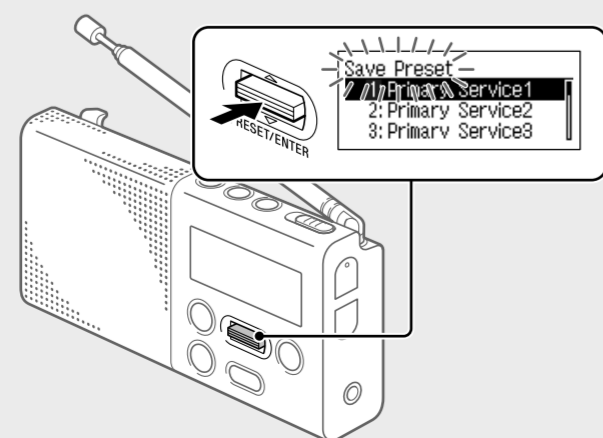

## 3 Select the desired preset number.

Slide the jog lever up or down to select the desired preset number (①), then press the lever (②).

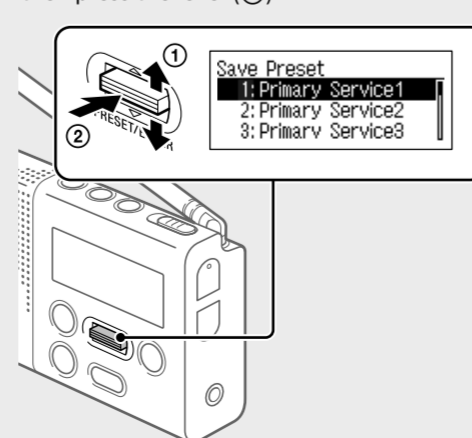

### Tips

- You can also preset stations from the setup menu. [MENU] → Save Preset
- The preset stations remain in the radio's memory even after a DAB auto tune is performed.
- If another station is already assigned to the selected preset number, that station is replaced by the new station.

## Listening to the stations from the preset list

## 1 Select DAB or FM.

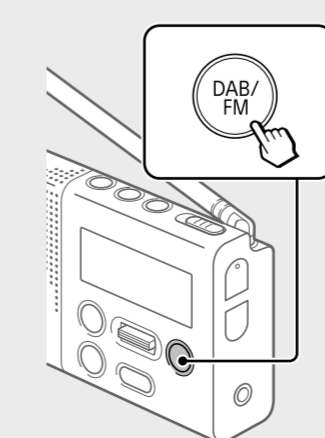

## 2 Press the jog lever to display the preset list.

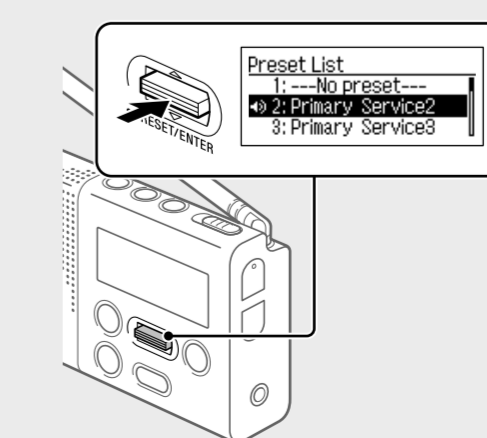

## 3 Select the desired station.

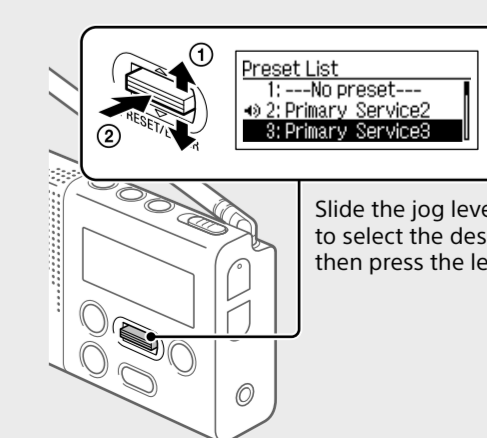

Slide the jog lever up or down to select the desired station (①), then press the lever (②).

## Guide to parts and controls

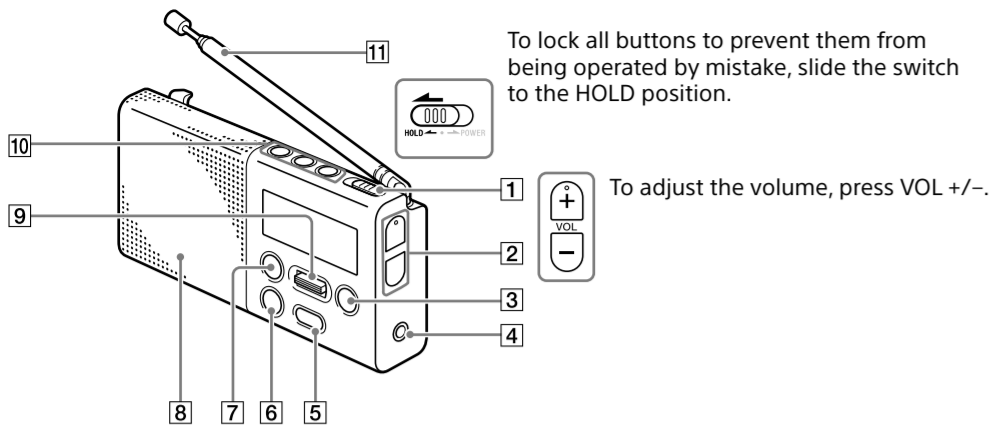

- 1 HOLD/POWER on/off switch
- 2 VOL +/- buttons\*
- 3 DAB/FM button
- 4 ⏏ (headphones) jack
- 5 AUTO TUNE button
- 6 BACK button
- 7 MENU button
- 8 Speaker
- 9 Jog lever
- 10 Favourite buttons
- 11 Antenna

To lock all buttons to prevent them from being operated by mistake, slide the switch to the HOLD position.

To adjust the volume, press VOL +/-.

\* The VOL + button has a tactile dot. Use the tactile dot as a reference when operating the radio.

## Setup Menu Options

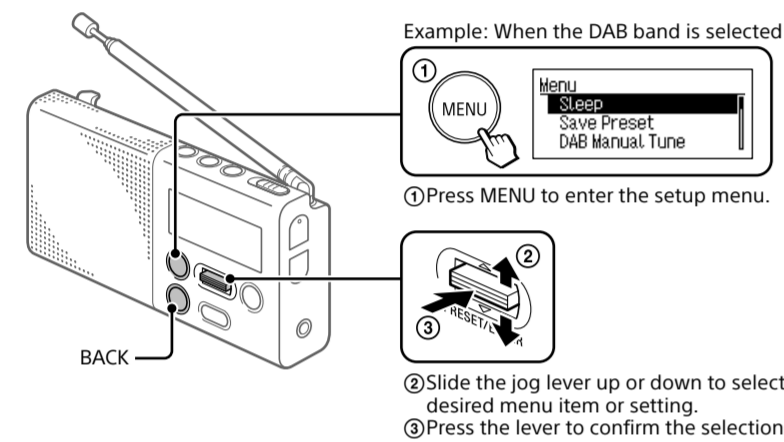

Example: When the DAB band is selected

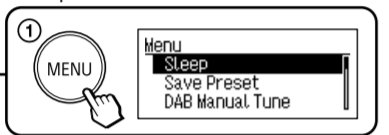

1 Press MENU to enter the setup menu.



2 Slide the jog lever up or down to select the desired menu item or setting.

3 Press the lever to confirm the selection.

### To go back to the upper menu level

Press BACK.

### To exit the setup menu

Press MENU again.

## Sleep

The radio automatically turns off after a set time has elapsed. Select the desired timer setting (minutes) from the following:

**Off** (deactivated)/**15 min./30 min./45 min./60 min.**

When the sleep timer is set, "SLEEP" lights up on the display.

## Save Preset

You can preset stations to the preset list.

## DAB Manual Tune

If DAB reception by DAB auto tune is poor, try manual tuning.

Slide the jog lever up or down to select the desired DAB channel, then press the lever.

The radio starts scanning for receivable stations in the selected channel.

### Tip

The new station received by manual tuning is stored in the DAB station list.

## Information

**DAB**  
Displays information for the station you are listening to. Slide the jog lever up or down to scroll through the following information:

**Channel:** Channel and frequency (See the DAB frequency table in "Specifications.")

**Multiplex Name:** Ensemble label (up to 16 characters long)

**Service Name:** Station name

**PTY:** PTY label (See "PTY (programme type)" in "Specifications.")

**Bit Rate:** Bit rate

**Signal Level :** Displays the signal level of the DAB station you are listening to, ranging from 0 (no signal) to 100 (maximum signal).

### FM

Displays PTY label (see "PTY (programme type)" in "Specifications") for the station you are listening to.

### Note

If there is no ensemble label or no station name, the space for label or name will be blank.

## Time

**Set Time:** "Auto (DAB)" is set by default. This enables the clock to synchronize with the DAB data being received. Select "Manual" to set the clock manually using the jog lever.

**12H/24H:** Select the clock display mode, 12-hour clock or 24-hour clock.

## Beep

Select "On" to activate the beep sound when you operate the radio.

## Initialize

Select "OK" to initialize the radio to the factory default settings. All settings, DAB and FM station lists and presets will be deleted.

## Listening through headphones

Connect headphones that have a stereo or monaural\* mini plug (not supplied).

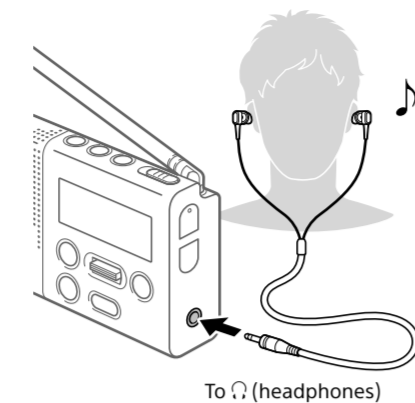

To ⏏ (headphones)

### Note

When connecting headphones to the unit, use headphones with a stereo (3-pole) or monaural (2-pole) mini plug. Sound may not be heard when using other types of plugs.

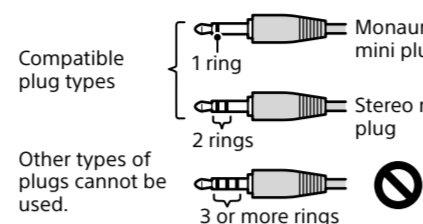

\* When listening to stereo sound using monaural headphones, you will hear sound from the left channel only.

### Tip

When connecting headphones to the unit, the headphones cord works as an antenna. Extend the cord as long as possible.

## Precautions

- Operate the unit only on the power sources specified in "Specifications."
- Use the unit within a temperature range of 0°C to 40°C. If it is used in temperatures higher than this range, the display may gradually turn black. If it is used in temperatures lower than this range, the display may change very slowly. (These irregularities will disappear and there will be no damage to the unit when the unit is used in the recommended temperature range again.)
- Avoid exposure to temperature extremes, direct sunlight, moisture, sand, dust or mechanical shock. Never leave in a car parked in the sun.
- Should any solid object or liquid fall into the unit, disconnect the micro USB cable, and have the unit checked by a qualified personnel before operating it any further.
- Since a strong magnet is used for the speakers, keep personal credit cards using magnetic coding or spring-wound watches away from the unit to prevent possible damage from the magnetism.
- To clean the casing, use a soft dry cloth. Do not use any type of solvent, such as alcohol or benzene, which may damage the finish.
- Do not operate the unit with wet hands since it may cause a short circuit.
- When you do not use the unit for a long time, charge the battery every 6 months.
- Make sure not to splash water on the unit. This unit is not waterproof.
- Under certain circumstances, especially when the air is very dry, it is not uncommon to experience a discharge of static electricity, or shock, when your body comes in contact with another object, in this case the ear buds touching your ear(s). The energy from this natural discharge is extremely small and is not emitted by your product but rather a natural environmental occurrence.



**Disposal of Old Electrical & Electronic Equipment (Applicable in the European Union and other European countries with separate collection systems)**

If you have any questions or problems concerning your unit, please consult your nearest Sony dealer.

## Troubleshooting

Should any problem persist after you have made the following checks, consult your nearest Sony dealer.

### Display is dim, or no indication is displayed.

- The radio is being used in extremely high or low temperatures or in a place with excessive moisture.

### Very weak or interrupted sound, or unsatisfactory reception.

- If you are in a building, listen near a window.
- Extend the antenna and adjust the length and the angle for best reception.

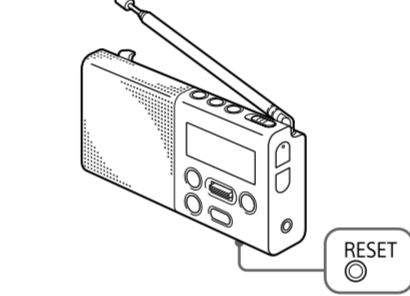
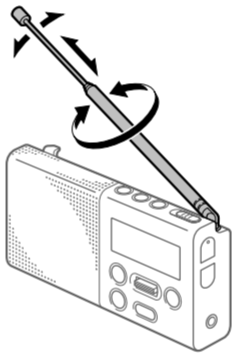

### If maintenance service is performed

All user-configured settings, such as preset radio stations, the sleep timer, and the clock, may be initialized.

Please note your settings in case you need to configure them again.

### Battery gets exhausted very quickly.

- Be sure to turn off the radio when not using it. The estimated battery life is 15 – 20 hours. See "Specifications" for details.

## Messages

### HOLD

- All buttons are locked because the HOLD/POWER on/off switch has been slid to the HOLD position.

### Low Battery (flashes, and the power is turned off)

- The battery is exhausted. Charge the battery.

### No preset

- No station has been preset.

### Service not available

- The selected station or service is currently not broadcasting.

## Specifications

### Frequency range

DAB (Band-III): 174.928 MHz – 239.200 MHz  
FM: 87.5 MHz – 108 MHz (0.05 MHz step)

### DAB (Band-III) frequency table (MHz)

Channel	Frequency	Channel	Frequency
5A	174.928	10A	209.936
5B	176.640	10B	211.648
5C	178.352	10C	213.360
5D	180.064	10D	215.072
6A	181.936	11A	216.928
6B	183.648	11B	218.640
6C	185.360	11C	220.352
6D	187.072	11D	222.064
7A	188.928	12A	223.936
7B	190.640	12B	225.648
7C	192.352	12C	227.360
7D	194.064	12D	229.072
8A	195.936	13A	230.784
8B	197.648	13B	232.496
8C	199.360	13C	234.208
8D	201.072	13D	235.776
9A	202.928	13E	237.488
9B	204.640	13F	239.200
9C	206.352		
9D	208.064		

**Speaker:** Approx. 45 mm dia., 4 Ω, monaural  
**Audio power output:** 1.5 W  
**Input:** DC IN 5 V (micro USB)  
**Output:** ⏏ (headphones) jack (ø 3.5 mm, stereo mini jack)

**Power requirements:** Lithium-ion rechargeable battery (1,300 mAh)

### Battery life\*

When listening through the speaker:

Approx. 15 hours

When listening through the headphone:

Approx. 20 hours

\* The actual battery life may vary depending on usage and circumstances.  
**Dimensions:** Approx. 115 mm × 57 mm × 24.5 mm (W/H/D)

**Mass:** Approx. 170 g  
**Supplied accessories:** Micro USB cable

Design and specifications are subject to change without notice.

### PTY (programme type)

This function indicates services or RDS data in programme type, such as News or Sports, transmitted in the DAB or RDS data.

If the received service or station does not transmit the programme type, "No PTY" appears.

Programme type	Display
No programme type	None
News	News
Current Affairs	Current Affairs
Information	Information
Sport	Sport
Education	Education
Drama	Drama
Culture	Arts
Science	Science
Varied	Talk
Pop Music	Pop Music
Rock Music	Rock Music
Easy Listening Music	Easy Listening
Light Classical	Light Classical
Serious Classical	Classical Music
Other Music	Other Music
Weather	Weather
Finance	Finance
Children's programmes	Children's
Social Affairs	Factual
Religion	Religion
Phone In	Phone In
Travel	Travel
Leisure	Leisure
Jazz Music	Jazz and Blues
Country Music	Country Music
National Music	National Music
Oldies Music	Oldies Music
Folk Music	Folk Music
Documentary	Documentary
Alarm Test	Alarm Test
Alarm	Alarm – Alarm !