

SONY®

4-733-073-11(1)



Television

Reference Guide



BRAVIA

OLED

KD-65A8F / 55A8F

Table of Contents

Safety Information	3
Precautions	5
Protecting the TV Screen (OLED TV)	6
Parts and Controls	7
Controls and Indicators	7
Using Remote Control	8
Remote Control Parts Description	8
Connection Diagram	10
Installing the TV to the Wall	12
SU-WL450	14
Troubleshooting	17
Troubles and Solutions	17
Specifications	18

Introduction

Thank you for choosing this Sony product. Before operating the TV, please read this manual thoroughly and retain it for future reference.

Note

- Before operating the TV, please read the “Safety Information” (page 3).
- Instructions about “Installing the TV to the Wall” are included within this TV’s instruction manual.
- Images and illustrations used in the Setup Guide and this manual are for reference only and may differ from the actual product.

Attaching the Table-Top Stand to the TV

Refer to the Setup Guide on top of the cushion.

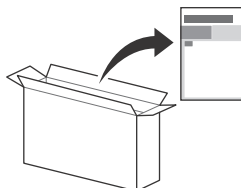

Help

Find more troubleshooting and other useful information directly from your TV. Press **HELP** on the remote control to display a list of topics, or to search by keyword.

Help Guide (Manual)

For more detailed information, select [Help Guide] from the Help menu on your TV. You can also check the Help Guide from your PC or smartphone (information provided on the back cover).

Location of the identification label

Labels for the TV Model No. and Power Supply rating are located on the rear of the TV. They can be found by removing the stand cover.

Notice for customers in Thailand

This telecommunication equipment and device conforms with NBTC standard or NBTC requirements.

This radio communication equipment has the electromagnetic field strength in compliance with the Safety Standard for the Use of Radio communication Equipment on Human Health announced by the National Telecommunications Commission.

Notes for Australia and New Zealand model

This product is ENERGY RATING qualified in the default mode. ENERGY RATING is a programme designed to promote energy efficient products and practices.

- When the TV is initially set up, it is designed to meet ENERGY RATING requirements while maintaining optimum picture quality.
- Changes to certain features, settings and functionalities of this TV (e.g. TV Guide, Picture/Sound, Eco setting) can slightly change the power consumption.

Depending upon such changed settings (e.g. Shop mode), the power consumption may vary which possibly could exceed the stated energy rating.

To reset the TV to ENERGY RATING qualified settings, complete the initial set-up procedure in [Settings] → [Storage & reset] → [Factory data reset].

After factory data reset, downloaded application data will be deleted. Please download them again.

Safety Information

WARNING

Caution

Risk of explosion if the battery is replaced by an incorrect type. Batteries must not be exposed to excessive heat such as sunshine, fire or the like or extremely low air pressure that can result in an explosion or leakage of flammable liquid or gas.

Stability Hazard

The television set may fall, causing serious personal injury or death.

Never place a television set in an unstable location. A television set may fall, causing serious personal injury or death. Many injuries, particularly to children, can be avoided by taking simple precautions such as:

- Using cabinets or stands recommended by the manufacturer of the television set.
- Only using furniture that can safely support the television set.
- Ensuring the television set is not overhanging the edge of the supporting furniture.
- Not placing the television set on tall furniture (for example, cupboards or bookcases) without anchoring both the furniture and the television set to a suitable support.
- Not placing the television set on cloth or other materials that may be located between the television set and supporting furniture.
- Educating children about the dangers of climbing on furniture to reach the television set or its controls.

If your existing television set is being retained and relocated, the same considerations as above should be applied.

Installation/Set-up

Install and use the TV set in accordance with the instructions below in order to avoid any risk of fire, electric shock or damage and/or injuries.

Apparatus connected to the protective earthing of the building installation through the mains connection or through other apparatus with a connection to protective earthing – and to a television distribution system using coaxial cable, may in some circumstances create a fire hazard. Connection to a television distribution system therefore has to be provided through a device providing electrical isolation below a certain frequency range (galvanic isolator, see EN 60728-11).

Installation

- The TV set should be installed near an easily accessible AC power outlet (mains socket).
- Place the TV set on a stable, level surface to prevent it from falling over and causing personal injury or property damage.
- Install the TV where it cannot be pulled, pushed, or knocked over.
- Install the TV so that the TV bottom does not protrude out from the TV stand (not supplied). If the TV bottom protrudes out from the TV stand, it may cause TV set to topple over, fall down, and cause personal injury or damage to the TV.

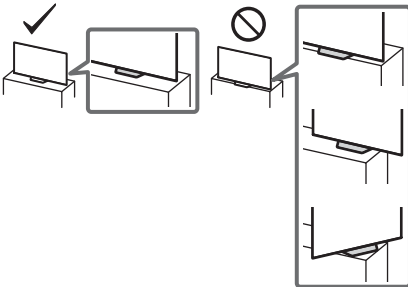

- Only qualified service personnel should carry out wall-mount installations.
- For safety reasons, it is strongly recommended that you use Sony accessories, including:
 - Wall-Mount Bracket SU-WL450

- Be sure to use the screws supplied with the TV when attaching the Wall-Mount Bracket to the TV set. The supplied screws are designed as indicated by illustration when measured from the attaching surface of the Wall-Mount Bracket. The diameter and length of the screws differ depending on the Wall-Mount Bracket model. Use of screws other than those supplied may result in internal damage to the TV set or cause it to fall, etc.

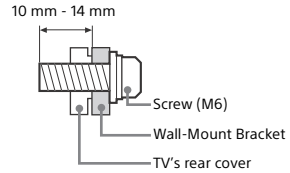

Transporting

- Before transporting the TV set, disconnect all cables.
- Two or three people are needed to transport a large TV set.
- When transporting the TV set by hand, hold it as shown below. Do not put stress on the panel and the frame around the screen.

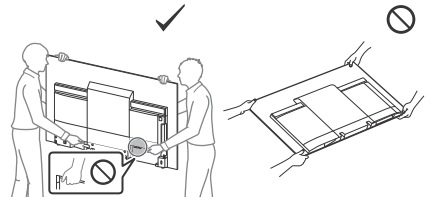

- When handling or mounting the TV set, do not lay down the TV.

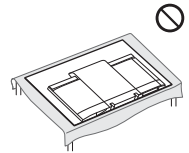

- When transporting the TV set, do not subject it to jolts or excessive vibration.
- When transporting the TV set for repairs or when moving, pack it using the original carton and packing material.

Topple prevention

(Except models with supplied support belt kit)

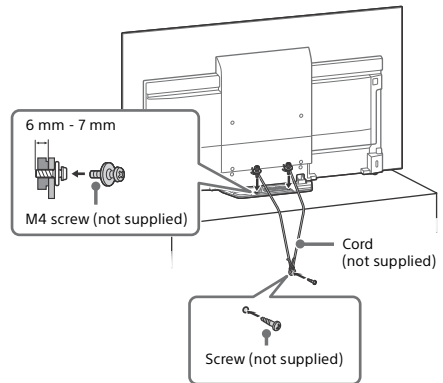

Ventilation

- Never cover the ventilation holes or insert anything in the cabinet.
- Leave space around the TV set as shown below.
- It is strongly recommended that you use a Sony Wall-Mount Bracket in order to provide adequate air circulation.

Installed on the wall

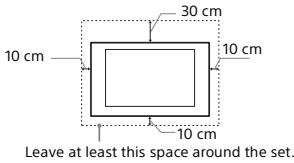

Installed with stand

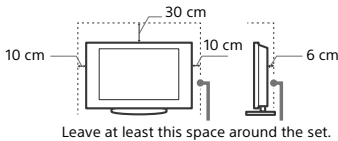

- To ensure proper ventilation and prevent the collection of dirt or dust:
 - Do not lay the TV set flat, install upside down, backwards, or sideways.
 - Do not place the TV set on a shelf, rug, bed or in a closet.
 - Do not cover the TV set with a cloth, such as curtains, or items such as newspapers, etc.
 - Do not install the TV set as shown below.

Air circulation is blocked.

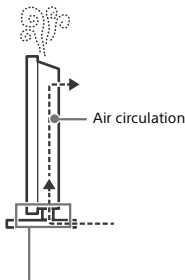
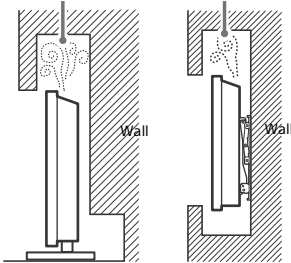

Do not block the air circulation area.

AC power cord (mains lead)

Handle the AC power cord (mains lead) and outlet (mains socket) as follows in order to avoid any risk of fire, electric shock or damage and/or injuries:

- The shape of AC power plug (mains plug), which is supplied with the TV set, varies depending on the region. Be sure to connect the appropriate supplied AC power cord (mains lead) with the plug that fits into the AC power outlet (mains socket).
- Use only Sony supplied AC power cords (mains lead), not those of other brands.
- Insert the plug fully into the AC power outlet (mains socket).
- Operate the TV set on a 110 V - 240 V AC supply only.
- When wiring cables, be sure to unplug the AC power cord (mains lead) for your safety and take care not to catch your feet on the cables.
- Disconnect the AC power cord (mains lead) from the AC power outlet (mains socket) before working on or moving the TV set.
- Keep the AC power cord (mains lead) away from heat sources.
- Unplug the AC power plug (mains plug) and clean it regularly. If the plug is covered with dust and it picks up moisture, its insulation may deteriorate, which could result in a fire.

Note

- Do not use the supplied AC power cord (mains lead) on any other equipment.
- Do not pinch, bend, or twist the AC power cord (mains lead) excessively. The core conductors may be exposed or broken.
- Do not modify the AC power cord (mains lead).
- Do not put anything heavy on the AC power cord (mains lead).
- Do not pull on the AC power cord (mains lead) itself when disconnecting the AC power cord (mains lead).
- Do not connect too many appliances to the same AC power outlet (mains socket).
- Do not use a poor fitting AC power outlet (mains socket).

Prohibited Usage

Do not install/use the TV set in locations, environments or situations such as those listed below, or the TV set may malfunction and cause a fire, electric shock, damage and/or injuries.

Locations:

- Outdoors (in direct sunlight), at the seashore, on a ship or other vessel, inside a vehicle, in medical institutions, unstable locations, near water, rain, moisture or smoke.

Environments:

- Places that are hot, humid, or excessively dusty; where insects may enter; where it might be exposed to mechanical vibration, near flammable objects (candles, etc.). The TV set shall not be exposed to dripping or splashing and no objects filled with liquids, such as vases, shall be placed on the TV.

Situations:

- Use when your hands are wet, with the cabinet removed, or with attachments not recommended by the manufacturer. Disconnect the TV set from AC power outlet (mains socket) and antenna (aerial) during lightning storms.
- Install the TV so that it sticks out into an open space. Injury or damage from a person or object bumping into the TV may result.



- Place the TV in a humid or dusty space, or in a room with oily smoke or steam (near cooking tables or humidifiers). Fire, electric shock, or warping may result.



- Install the TV in places subject to extreme temperature such as in direct sunlight, near a radiator or a heating vent. The TV may overheat in such condition which can cause deformation of the enclosure and/or TV malfunction.

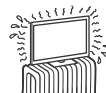

- If the TV is placed in the changing room of a public bath or hot spring, the TV may be damaged by airborne sulfur, etc.



- For best picture quality, do not expose the screen to direct illumination or sunlight.
- Avoid moving the TV from a cold area to a warm area. Sudden room temperature changes may cause moisture condensation. This may cause the TV to show poor picture and/or poor colour. Should this occur, allow moisture to evaporate completely before powering the TV on.

Broken pieces:

- Do not throw anything at the TV set. The screen glass may break by the impact and cause serious injury.
- If the surface of the TV set cracks, do not touch it until you have unplugged the AC power cord (mains lead). Otherwise this may cause an electric shock.

When not in use

- If you will not be using the TV set for several days, the TV set should be disconnected from the AC power (mains) for environmental and safety reasons.
- As the TV set is not disconnected from the AC power (mains) when the TV set is just turned off, pull the plug from the AC power outlet (mains socket) to disconnect the TV set completely.
- Some TV sets may have features that require the TV set to be left in standby to work correctly.

For children

- Do not allow children to climb on the TV set.
- Keep small accessories out of the reach of children, so that they are not mistakenly swallowed.

If the following problems occur...

Turn off the TV set and unplug the AC power cord (mains lead) immediately if any of the following problems occur. Ask your dealer or Sony service centre to have it checked by qualified service personnel.

When:

- AC power cord (mains lead) is damaged.
- Poor fitting of AC power outlet (mains socket).
- TV set is damaged by being dropped, hit or having something thrown at it.
- Any liquid or solid object falls through openings in the cabinet.

About TV Temperature

When the TV is used for an extended period, the panel surrounds become warm. You may feel hot when touching there by the hand.

Precautions

Viewing the TV

- View the TV in moderate light, as viewing the TV in poor light or during long period of time, strains your eyes.
- When using headphones, adjust the volume so as to avoid excessive levels, as hearing damage may result.

OLED Screen

- Although the OLED screen is made with high-precision technology and 99.99 % or more of the pixels are effective, black dots may appear or bright points of light (white, red, blue, or green) may appear constantly on the OLED screen. This is a structural property of the OLED screen and is not a malfunction.
- Do not push or scratch the front filter, or place objects on top of this TV set. The image may be uneven or the OLED screen may be damaged.
- The screen and cabinet get warm when this TV set is in use. This is not a malfunction.
- When disposing of your TV be sure to follow your local laws and regulations.

Handling and cleaning the screen surface/ cabinet of the TV set

Be sure to unplug the AC power cord (mains lead) connected to the TV set from AC power outlet (mains socket) before cleaning. To avoid material degradation or screen coating degradation, observe the following precautions.

- To remove dust from the screen surface/cabinet, wipe gently with a soft cloth. If dust is persistent, wipe with a soft cloth slightly moistened with a diluted mild detergent solution.
- Never spray water or detergent directly on the TV set. It may drip to the bottom of the screen or exterior parts and enter the TV set, and may cause damage to the TV set.
- Never use any type of abrasive pad, alkaline/acid cleaner, scouring powder, or volatile solvent, such as alcohol, benzene, thinner or insecticide. Using such materials or maintaining prolonged contact with rubber or vinyl materials may result in damage to the screen surface and cabinet material.
- Do not touch the TV if your hand is covered in any chemical substance such as hand cream or sunblock.
- Periodic vacuuming of the ventilation openings is recommended to ensure proper ventilation.
- When adjusting the angle of the TV set, move it slowly so as to prevent the TV set from moving or slipping off from its table stand.



Optional Equipment

Keep optional components or any equipment emitting electromagnetic radiation away from the TV set. Otherwise picture distortion and/or noisy sound may occur.

Wireless Function of the unit

- Do not operate this unit near medical equipment (pacemaker, etc.), as this may result in the malfunction of the medical equipment.
- Although this unit transmits/receives scrambled signals, be careful of unauthorised interception. We cannot be responsible for any trouble as a result.

Caution about handling the remote control

- Observe the correct polarity when inserting batteries.
- Do not use different types of batteries together or mix old and new batteries.
- Dispose of batteries in an environmentally friendly way. Certain regions may regulate the disposal of batteries. Please consult your local authority.
- Handle the remote control with care. Do not drop or step on it, or spill liquid of any kind onto it.
- Do not place the remote control in a location near a heat source, a place subject to direct sunlight, or a damp room.

Disposal of the TV set



Disposal of old electrical & electronic equipment (applicable in the European Union and other countries with separate collection systems)



Disposal of Old Electrical & Electronic Equipment (Applicable in Republic of India)

This symbol and its variations indicate that this product and its components, consumables, parts or spares thereof shall not be treated as household waste and may not be dropped in garbage bins. Product owners are advised to deposit their product at the nearest collection

point for the recycling of electrical and electronic equipment. Your co-operation shall facilitate proper disposal and help prevent potential negative consequences/hazards to the environment and human health, which could otherwise be caused by inappropriate waste disposal including improper handling, accidental breakage, damage and/or improper recycling of e-waste. The recycling of materials will help to conserve natural resources. For more detailed information about recycling of this product, please contact your local civic office, your household waste disposal service provider or the store where you made the purchase. You may contact our company's toll free number in India for assistance.

Toll Free: 1800-103-7799

Visit: www.sony.co.in for product recycling

Reduction in the Use of Hazardous Substances in Electrical & Electronic Equipment (Applicable in Republic of India)

This product and its components, consumables, parts or spares comply with the hazardous substances restriction of India's E-Waste (Management) Rules. The maximum allowable concentrations of the restricted substances are 0.1 % by weight in homogenous materials for Lead, Mercury, Hexavalent Chromium, Polybrominated Biphenyls (PBB) and Polybrominated Diphenyl Ethers (PBDE), and 0.01 % by weight in homogenous materials for Cadmium, except for the exemptions specified in Schedule II of the aforesaid Rules.

Notice for customer in UAE

TRA

REGISTERED No: ER47793/16

DEALER No: DA0065531/11

Protecting the TV Screen (OLED TV)

Precautions to Protect the Screen from Damage

Image retention

OLED TV's are susceptible to image retention (burn-in) due to the characteristics of the materials used. Image retention may occur if images are displayed in the same location on the screen repeatedly or over extended periods of time. This is not a malfunction of the TV. Avoid displaying images that may cause image retention.

The following are examples of images that may cause image retention:

- Content with black bars either on the top and bottom and/or the left and right sides of the screen. (for example, Letterboxed, 4:3 screen, Standard definition)
- Static images such as photos.
- Video games that might have static content in some part of the screen.
- On-screen menus, programme guides, channel logos etc.
- Static content from applications.
- On-screen tickers, such as those used for news and headlines.

To reduce the risk of image retention:

- Sony recommends that you turn off the TV normally by pressing the power button on the remote control or the TV.
- Fill the screen by changing [Wide mode] to eliminate the black bars. Select [Wide mode] other than [Normal].
- Turn off the OSD (On Screen Display) by pressing the  button, and turn off the menus from connected equipment. For details, refer to the instruction manuals for the connected equipment.
- Avoid displaying static images with bright colours (including white), clocks or logos on any portion of the screen.
- Set the picture settings based on the ambient conditions. The Standard Picture is recommended for home use and when viewing content that often displays the station logos, etc.

The TV has following features to help reduce/ prevent image retention.

Panel refresh

Panel refresh will automatically run to adjust the uniformity of the TV screen after it has been in use for long periods of time. Panel refresh can also be performed manually and should only be used if image retention is very noticeable or you see the following message: [Panel refresh did not finish...]

Caution:

- The Panel refresh function may affect the panel. As a reference, perform the Panel refresh only once a year, do not perform it more than once a year as it may affect the usable life of the panel.
- Panel refresh takes about one hour to complete.
- A white line may be displayed on the screen during the Panel refresh, this is not a malfunction of the TV.
- Panel refresh will only work when the room temperature is between 10 °C and 40 °C.

Pixel shift

Automatically moves the image on the screen to prevent image retention.

Other feature

The screen brightness is automatically reduced when displaying still images, clocks, bright colours or logos etc.

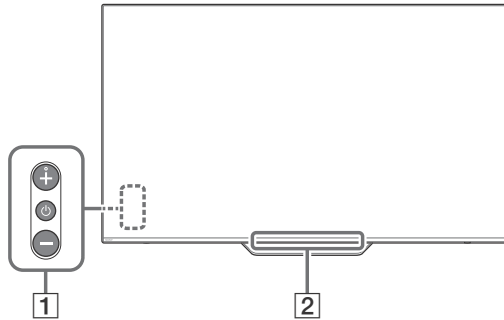

Parts and Controls

Controls and Indicators



1 (Power) / + / -

When the TV is off,
Press  to power on.

When the TV is on,
Press and hold  to power off.
Press  repeatedly to change the function,

then press + or - button to:

- Adjust the volume.
- Select the channel.
- Select the input source of TV.

2 **Remote Control sensor* / Light sensor* / Illumination LED**

The illumination LED lights up or blinks according to the status of the TV.

For more information, refer to the Help Guide.

* Do not place anything near the sensor.

Using Remote Control

Remote Control Parts Description

The remote control shape, location, availability and function of remote control buttons may vary depending on your region/country/TV model.

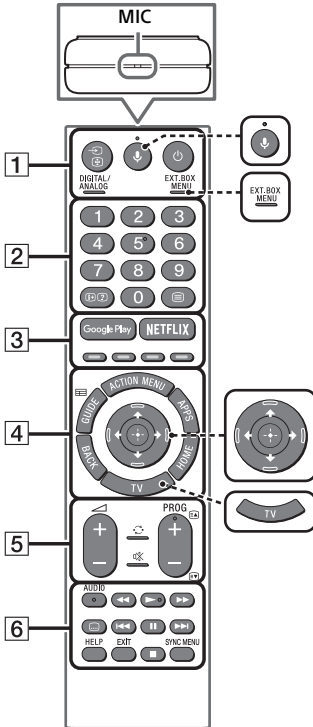



 **↓ (Microphone)**
Use Voice Search. (e.g., Search various content by voice.)

 **EXT. BOX MENU**
Display the connected External Box (cable/satellite box) menu.

- For models with supplied IR Blaster, connect and set up the IR Blaster (page 11).
- The External Box menu may be displayed for some HDMI CEC compatible devices when the IR Blaster is not supplied/connected.



 **↑/↓/←/→/⊕ (Navigation D-Pad)**
On screen menu navigation and selection.

 **TV**
Switch to a TV channel or input and display the TV Menu Bar.

- 1**  **(Input select/Text hold)**
In TV mode: Display and select the input source.
In Text mode: Hold the current page.

 **(TV standby)**
Turn on or turn off the TV (standby mode).

DIGITAL/ANALOG
Switch between digital and analogue mode.

- 2** **Number buttons**
-  **(Info/Text reveal)**
Display information.
-  **(Text)**
Display text information.

3 Google Play

Access the "Google Play" online service.

NETFLIX (Only on limited region/ country/TV model)

Access the "NETFLIX" online service.

Colour buttons

Execute corresponding function at that time.

4 ACTION MENU

Display a list of contextual functions.

GUIDE/

Display the digital programme guide.

APPS

Access various services and applications.

BACK

Return to the previous screen.

HOME

Display the TV Home Menu.

5 +/- (Volume)

Adjust the volume.

(Jump)



Jump back and forth between two channels or inputs. The TV alternates between the current channel or input and the last channel or input that was selected.

(Muting)

Mute the sound. Press again to restore the sound.

PROG +/-//

In TV mode: Select the channel.

In Text mode: Select the next () or previous () page.

6 AUDIO

Change the language for the programme currently being viewed.



Operate media contents on the TV and connected BRAVIA Sync-compatible device.

(Subtitle setting)

Turn subtitles on or off (when the feature is available).

HELP

Display the Help menu. Help Guide can be accessed from here.

EXIT

Return to the previous screen or exit from the menu. When an Interactive Application service is available, press to exit from the service.

SYNC MENU

Display the BRAVIA Sync Menu.

Connection Diagram

For more information on connections, refer to the Help Guide by pressing **HELP** on the remote control.

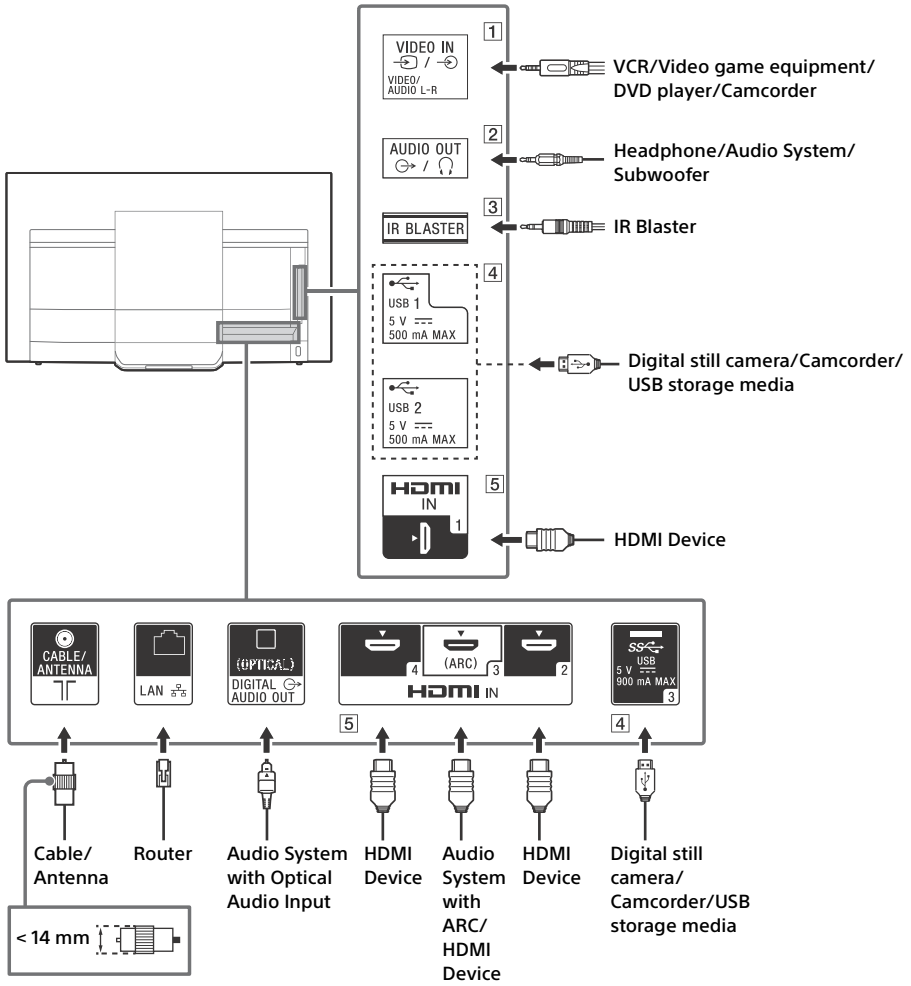

1 VIDEO IN

- For a composite connection, use an Analogue Extension Cable (not supplied).

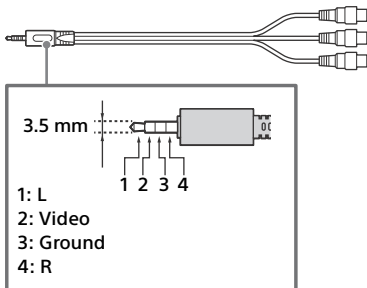

2 AUDIO OUT

- Supports 3-pole stereo mini jack only.
- To listen to the TV's sound through the connected equipment, press **HOME**. Select [Settings] → [Sound] → [Headphone/Audio out] and then select the desired item.

3 IR BLASTER*

- Use your Sony remote control to control your External Box (cable/satellite box). Connect the IR Blaster Cable* to the IR Blaster port on your TV. Place one or both of the other two ends as shown below.

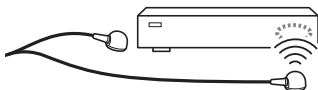

- To perform IR Blaster setup, press **HOME** and select [Settings] → [External inputs] → [IR Blaster setup].

4 USB 1/2, USB 3

- Connecting a large USB device may interfere with other connected devices beside it.
- When connecting a large USB device, connect to the USB 1 port.

5 HDMI IN 1/2/3/4

- HDMI interface can transfer the digital video and audio on a single cable.

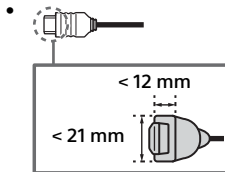

• HDMI IN 2/3

To enjoy high quality 4K 50p/60p contents, connect a Premium High Speed HDMI cable to the HDMI IN 2/3 and set the [HDMI signal format] to [Enhanced format].

For details of supported formats, refer to the "Specifications" in this manual (page 18-19).

• HDMI IN 3 ARC (Audio Return Channel)

Connect your audio system to the HDMI IN 3 to route TV audio to your audio system. An audio system that supports HDMI ARC can send video to the TV, and receive audio from the TV via the same HDMI cable. If your audio system does not support HDMI ARC, an additional connection with DIGITAL AUDIO OUT (OPTICAL) is necessary.

* Only on limited region/country/TV model.

Note

- You cannot attach the side cover  while the cables are connected to side terminal.
- Be sure to store the side cover in a safe place for future use.

Installing the TV to the Wall

This TV's instruction manual only provides the steps to prepare the TV for Wall-Mount installation before it is installed on the wall.

To Customers:

For product protection and safety reasons, Sony strongly recommends that installation of your TV be performed by Sony dealers or licensed contractors. Do not attempt to install it yourself.

To Sony Dealers and Contractors:

Provide full attention to safety during the installation, periodic maintenance and examination of this product.

Sufficient expertise is required for installing this product, especially to determine the strength of the wall for withstanding the TV's weight. Be sure to entrust the attachment of this product to the wall to Sony dealers or licensed contractors and pay adequate attention to safety during the installation. Sony is not liable for any damage or injury caused by mishandling or improper installation.

Use the Wall-Mount Bracket SU-WL450 (not supplied) to install the TV to the wall.

When installing the Wall-Mount Bracket, also refer to the Operating Instructions and Installation Guide supplied with the Wall-Mount Bracket.

Note

- You can remove the foot parts and screws after the TV is completely installed to the wall.

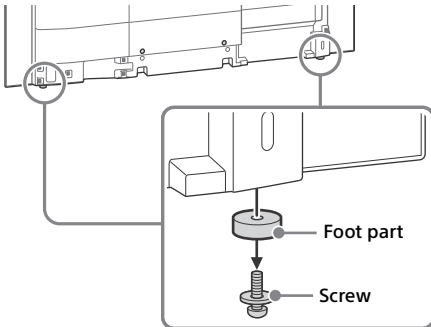

- Be sure to store the removed foot parts and screws in a safe place, keeping them away from children.
- Be sure to attach the foot parts and screws at original position when using the Table-Top Stand. If using an electric screwdriver, set the torque at approximately 0.4 N·m {4 kgf·cm}.

Installing the TV to the Wall from Table-Top Stand

- 1 Remove the stand cover and terminal covers.

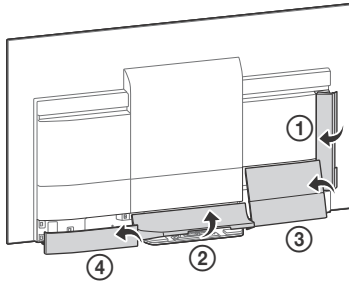

- 2 Remove the screws from the rear of the TV.

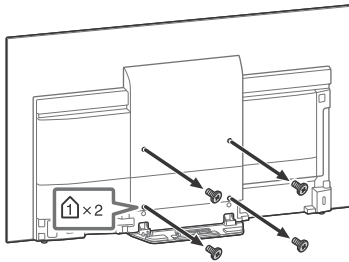

SU-WL450

- 1 Make sure that the wall has enough space for the TV and is capable of supporting a weight of at least four times that of the TV.
Refer to the following table on installing the TV to the wall. See page 18-20 (Specifications) for the TV's weight.

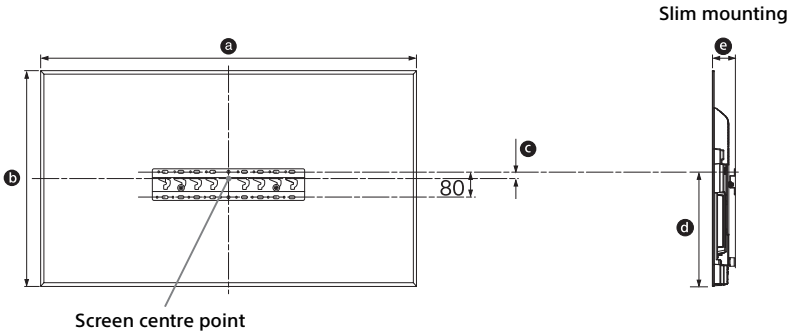

Unit: mm

Model Name	Display dimensions		Screen centre dimension	Length for mounting	
	a	b	c	d	e
	Slim mounting				
KD-65A8F	1,447	836	20	445	76
KD-55A8F	1,226	712	-19*	346	76

* Bracket positioning is below the screen centre point.

Note

- Figures in the table may differ slightly depending on the installation.
- When your TV is installed on the wall, the upper side of the TV slightly leans forward.

2 Attach the Attachment parts for Wall-Mount Bracket. Check the Attachment parts by referring to "1" of the Wall-Mount Bracket Installation Guide.

Note

- If using an electric screwdriver, set the torque at approximately 1.5 N·m {15 kgf·cm}.
- Be sure to store the unused parts in a safe place for future use. Retain this manual for future reference.

Slim mounting

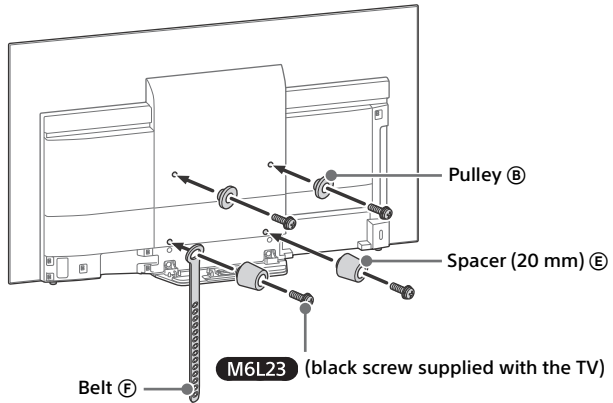

3 Connect necessary cables to the TV.

Note

- You cannot access to any terminal after installing the TV to the wall.

4 Detach the Table-Top Stand from the TV.

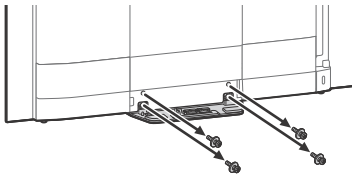

5 Install the TV to the Base. Refer to “5” of Installation Guide and “Installing the TV to the Wall” of Operating Instructions supplied with the Wall-Mount Bracket.

Model Name	Hook location
KD-65A8F	b
KD-55A8F	

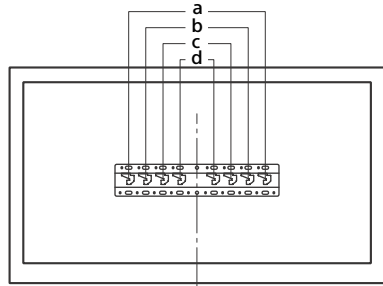

Refer to the instructions supplied with the Wall-Mount Bracket for your model to install the TV on the wall.

Troubleshooting

General troubleshooting for issues like: black screen, no sound, frozen picture, TV does not respond, or network is lost, do the following steps.

- 1 Restart your TV by pressing the power button on the remote control until a message appears. The TV will restart. If the TV does not recover, try unplugging the TV from the AC power cord (mains lead) for three minutes and then plug it in again.
- 2 Refer to the Help menu by pressing **HELP** on the remote control.
- 3 Connect your TV to the Internet and perform a software update.
- 4 Visit Sony support website (information provided on the back cover).

When [A new TV system software update is available...] message is displayed.

Sony strongly recommends you to update the TV software by selecting [Update Now]. These software updates improve your TV performance or add new features.

The following screen with [Updating...] will appear and the illumination LED flashes white while software is updating.

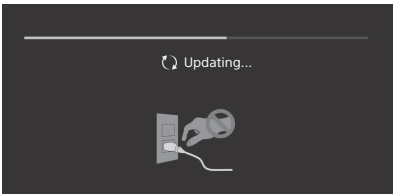

Do not unplug the AC power cord (mains lead) during the software update. If you do, the software update may not finish completely, and it may cause a software malfunction. Software updates can take up to 15 minutes.

When you plug in the TV, the TV may not be able to turn on for a while even if you press the power button on the remote control or the TV.

It takes time to initialize the system. Wait for about one minute, then operate it again.

Troubles and Solutions

When the illumination LED is flashing in red.

- Count how many times it flashes (interval time is three seconds).
Reboot the TV by disconnecting the AC power cord (mains lead) for three minutes, then turn on the TV.
If the problem persists, disconnect the AC power cord (mains lead), and contact your dealer or Sony service centre with the number of times the illumination LED flashes.

There is no picture (screen is dark) and no sound.

- Check the antenna (aerial)/cable connection.
- Connect the TV to the AC power (mains), and press the power button on the TV or the remote control.

Some programmes cannot be tuned.

- Check the antenna (aerial)/cable connection.

The remote control does not function.

- Replace the batteries.

The EXT.BOX MENU button on the remote control does not work.

- Connect and set up the IR Blaster (models with supplied IR Blaster only) (page 11).
- Connect HDMI CEC compatible device (except models with supplied IR Blaster) and change to that input.

The parental lock for broadcast password has been forgotten.

- Enter 9999 for the PIN code and select [Change PIN code].

The TV surrounds become warm.

- When the TV is used for an extended period, the TV surrounds become warm. You may feel hot when touching there by the hand.

The screen becomes darker while watching TV.

- If the whole image or part of the image remains still, the screen brightness will be gradually reduced to prevent image retention. This is not a malfunction of the TV.

You are concerned about image retention.

If the same image is displayed repeatedly or for long periods of time, image retention may occur. To reduce image retention, we recommend that you turn off the TV normally by pressing the power button on the remote control or the TV.

Note

- Perform Panel refresh manually only when image retention is particularly noticeable. As a reference, perform it only once a year. Avoid performing it more than once a year because it may affect the usable life of the panel.
- Images that include clocks, logos and bright colours (including white) easily cause image retention. Avoid displaying these types of images for long periods of time, otherwise image retention may occur.

A white line appears on the screen.

- Panel refresh automatically runs after the TV has been used for long periods of time to reduce image retention. Panel refresh starts after the TV is turned off and takes about one hour to complete. A white line may be displayed on the screen during the Panel refresh. This is not a malfunction of the TV.

The message [Panel refresh did not finish...] is displayed.

Panel refresh automatically runs after the TV has been used for long periods of time to reduce image retention. If the TV is turned on, the AC power cord (mains lead) is unplugged, or the room temperature falls outside of the range between 10 °C and 40 °C during the Panel refresh, the process will not be completed and this message will appear.

- If Panel refresh started automatically, it will restart when you turn off the TV with the remote control.
- If Panel refresh initiated manually, you must select it again.

Specifications

System

Panel system

OLED (Organic Light Emitting Diode) Panel

TV system

Depend on your country/area selection

Analogue: B/G, I, D/K, M

Digital: DVB-T/DVB-T2

Colour system

PAL/SECAM/NTSC3.58/NTSC4.43

Channel coverage

Depend on your country/area selection

Analogue: UHF/VHF/Cable

Digital: UHF/VHF

Sound output

10 W + 10 W + 10 W + 10 W + 10 W

Wireless technology

Protocol IEEE802.11ac/a/b/g/n

(IEEE802.11ac may not be available depending on countries/regions.)

Bluetooth Version 4.1

Input/Output jacks

Antenna (aerial)/cable

75 ohm external terminal for VHF/UHF

—(S) / —(A) VIDEO IN

Video/Audio input (mini jack)

HDMI IN 1/2/3/4 (support 4K resolution, HDCP 2.2-compatible)

Video:

4096 × 2160p (50, 60 Hz)^{*1+2}, 4096 × 2160p (24 Hz)^{*1}, 3840 × 2160p (50, 60 Hz)^{*2}, 3840 × 2160p (24, 25, 30 Hz), 1080p (30, 50, 60 Hz), 1080/24p, 1080i (50, 60 Hz), 720p (30, 50, 60 Hz), 720/24p, 576p, 576i, 480p, 480i, PC Formats^{*3}

^{*1} When 4096 × 2160p is input and [Wide mode] is set to [Normal], the resolution is displayed as 3840 × 2160p. To display 4096 × 2160p, set [Wide mode] setting to [Full 1] or [Full 2].

^{*2} HDMI IN 2/3 only. To support 18 Gbps, set [HDMI signal format] to [Enhanced format].

^{*3} Refer to the Help Guide for details.

Audio:

5.1 channel linear PCM: 32/44.1/48/88.2/96/176.4/192 kHz 16/20/24 bits, Dolby Digital, Dolby Digital Plus and DTS

ARC (Audio Return Channel) (HDMI IN 3 only)
(Two channel linear PCM: 48 kHz 16 bits, Dolby Digital, Dolby Digital Plus, DTS)

DIGITAL AUDIO OUT (OPTICAL)

Digital optical jack (Two channel linear PCM:
48 kHz 16 bits, Dolby Digital, DTS)

AUDIO OUT (Stereo mini jack)

Headphone, Audio output, Subwoofer

1, 2, 3

USB port 1 and 2 support High Speed USB
(USB 2.0)

USB port 3 supports Super Speed USB (USB 3.1
Gen 1)

LAN

10BASE-T/100BASE-TX connector (Depending on
the operating environment of the network,
connection speed may differ. 10BASE-T/
100BASE-TX communication rate and
communication quality are not guaranteed for
this TV.)

IR BLASTER*1

IR Blaster Cable input (mini jack)

Others

Optional accessories

Wall-Mount Bracket: SU-WL450

Operating temperature

0 °C - 40 °C

Power and others

Power requirements

110 V - 240 V AC, 50/60 Hz

Energy Efficiency Class*2

KD-65A8F: B

KD-55A8F: B

Screen size (measured diagonally) (Approx.)

KD-65A8F: 65 inches / 163.9 cm

KD-55A8F: 55 inches / 138.8 cm

Power consumption

Indicated on the rear of the TV

Power Consumption*2

in [Standard] mode

KD-65A8F: 186 W

KD-55A8F: 149 W

in [Vivid] mode

KD-65A8F: 480 W

KD-55A8F: 371 W

Average annual energy consumption*2*3

KD-65A8F: 258 kWh

KD-55A8F: 207 kWh

Standby power consumption*2*4*5

0.50 W

Display resolution

3,840 pixels (horizontal) × 2,160 lines (vertical)

Output Rating

USB 1/2

5 V , 500 mA MAX

USB 3

5 V , 900 mA MAX

Dimensions (Approx.) (w × h × d)

with Table-Top Stand

KD-65A8F: 1,447 × 841 × 255 mm

KD-55A8F: 1,226 × 717 × 255 mm

without Table-Top Stand

KD-65A8F: 1,447 × 836 × 55 mm

KD-55A8F: 1,226 × 712 × 55 mm

Mass (Approx.)

with Table-Top Stand

KD-65A8F: 28 kg

KD-55A8F: 22.2 kg

without Table-Top Stand

KD-65A8F: 24.4 kg

KD-55A8F: 18.7 kg

*1 Only on limited region/country/TV model.

*2 This information is for EU and other countries
whose relevant regulation is based on EU energy
labelling regulation.

*3 Energy consumption per year, based on the
power consumption of the Television operating 4
hours per day for 365 days. The actual energy
consumption will depend on how the Television
is used.

*4 Specified standby power is reached after the TV
finishes necessary internal processes.

*5 Standby power consumption will increase when
your TV is connected to the network.

Note

- Optional accessories availability depends on countries/region/TV model/stock.
- Design and specifications are subject to change without notice.

Notes on Digital TV function

- Any functions related to Digital TV (DVB) will only work in countries or areas where DVB-T/DVB-T2 (MPEG-2 and H.264/MPEG-4 AVC) digital terrestrial signals are broadcast. Please confirm with your local dealer if you can receive a DVB-T/DVB-T2 signal where you live.
- This TV set complies with DVB-T/DVB-T2 specifications, but compatibility with future DVB-T/DVB-T2 digital terrestrial broadcasts are not guaranteed.
- Some Digital TV functions may not be available in some countries/areas.

Trademark Information

- The terms HDMI and HDMI High-Definition Multimedia Interface, and the HDMI Logo are trademarks or registered trademarks of HDMI Licensing Administrator, Inc. in the United States and other countries.
- Manufactured under license from Dolby Laboratories. Dolby, Dolby Audio, and the double-D symbol are trademarks of Dolby Laboratories.
- "BRAVIA", BRAVIA and BRAVIA Sync are trademarks or registered marks of Sony Corporation.
- Gracenote, the Gracenote logo and logotype, "Powered by Gracenote" logo are either registered trademarks or trademarks of Gracenote, Inc. in the United States and/or other countries.
- Vewd® Core. Copyright 1995-2017 Vewd Software AS. All rights reserved.
- Google, Android TV, Google Play, Chromecast built-in, YouTube and other related marks and logos are trademarks of Google LLC.
- Wi-Fi®, Wi-Fi Alliance®, Wi-Fi Direct® and Miracast® are registered trademarks of Wi-Fi Alliance.
- Wi-Fi Protected Setup™ is a trademark of Wi-Fi Alliance.
- The Wi-Fi CERTIFIED™ Logo is a certification mark of Wi-Fi Alliance.
- For DTS patents, see <http://patents.dts.com>. Manufactured under license from DTS, Inc. DTS, the Symbol, & DTS and the Symbol together are registered trademarks, and DTS Digital Surround is a trademark of DTS, Inc. © DTS, Inc. All Rights Reserved.
- The Bluetooth® word mark and logos are registered trademarks owned by the Bluetooth SIG, Inc. and any use of such marks by Sony Corporation is under license. Other trademarks and trade names are those of their respective owners.
- Netflix is a registered trademark of Netflix, Inc.
- TUXERA is a registered trademark of Tuxera Inc. in the US and other countries.
- USB-IF SuperSpeed USB Trident logo is a registered trademark of USB Implementers Forum, Inc. 

- All other trademarks are the property of their respective owners.





Help Guide

http://rd1.sony.net/help/tv/fga1/h_ga/



Customer Support and Contact:

<http://www.sony-asia.com/support>

<http://www.sony.net/>