

Digital Still Camera

Instruction Manual



"Help Guide" (Web manual)

Refer to "Help Guide" for in-depth instructions on the many functions of the camera.

http://rd1.sony.net/help/dsc/1750/h_zz/

Cyber-shot

Check out the Help Guide!



The “Help Guide” is an on-line manual that you can read on your computer or smartphone. Refer to it for details on menu items, advanced usage, and the latest information on the camera.



Scan here

http://rd1.sony.net/help/dsc/1750/h_zz/

DSC-RX100M6 Help Guide



Instruction Manual (this book)



This manual introduces some basic functions.

For the quick start guide, see “Startup guide” (page 14). The “Startup guide” introduces the initial procedures from when you open the package until you release the shutter for the first shot.

In-Camera Guide



The [In-Camera Guide] shows explanations of the menu items on the monitor of the camera.

You can quickly pull up information during shooting. To use the [In-Camera Guide] function, some settings must be made beforehand. For details, search “In-Camera Guide” in the Help Guide.

Notes on using your camera

Along with this section, also see “Precautions” in the Help Guide (page 2).

Screen language

You can select the language displayed on the screen using the menu (page 26).

Notes on handling the product

- The camera is neither dust-proof, nor splash-proof, nor water-proof. See “Precautions” in the Help Guide.
 - If water, dust, or sand gets inside the open viewfinder unit or flash unit, it may cause a malfunction.
 - Remove any dirt from the surface of the flash. Dirt on the surface of the flash may emit smoke or burn due to heat generated by the emission of light. If there is dirt/dust, clean it off with a soft cloth.
 - Do not cover the flash with your fingers.
 - Do not sit down in a chair or other place with the camera in the back pocket of your trousers or skirt, as this may cause a malfunction or damage the camera.
 - When using the power zoom lens, be careful not to get your fingers or any other objects caught in the lens.
 - Make sure that your finger is not in the way when you push down the viewfinder or flash.
 - Do not carry the camera by the viewfinder unit, or use excessive strength on it.
- Do not leave the lens or the viewfinder exposed to a strong light source such as sunlight. Because of the lens’s condensing function, doing so may cause smoke, fire, or a malfunction inside the camera body or the lens.
 - When you shoot with backlighting, keep the sun sufficiently far away from the angle of view. Otherwise, the sunlight may focus inside the camera and cause smoke or fire. Even if the sun is slightly away from the angle of view, it may still cause smoke or fire.
 - Do not directly expose the lens to beams such as laser beams. That may damage the image sensor and cause the camera to malfunction.
 - Do not leave the camera, the supplied accessories, or memory cards within the reach of infants. They may be accidentally swallowed. If this occurs, consult a doctor immediately.

Notes on the monitor and electronic viewfinder

- The monitor and electronic viewfinder are manufactured using extremely high-precision technology, and over 99.99% of the pixels are operational for effective use. However, there may be some small black dots and/or bright dots (white, red, blue or green in color) that constantly appear on the monitor and electronic viewfinder. These are imperfections due to the manufacturing process and do not affect the recorded images in any way.

- The image may be slightly distorted near the corners of the viewfinder. This is not a malfunction. When you want to see the full composition with all its details, you can also use the monitor.
- If you pan the camera while looking into the viewfinder or move your eyes around, the image in the viewfinder may be distorted or the color of the image may change. This is a characteristic of the lens or display device and is not a malfunction. When you shoot an image, we recommend that you look at the center area of the viewfinder.
- When shooting with the viewfinder, you may experience symptoms such as eyestrain, fatigue, travel sickness, or nausea. We recommend that you take a break at regular intervals when you are shooting with the viewfinder. In case you may feel uncomfortable, refrain from using the viewfinder until your condition recovers, and consult your doctor if necessary.
- If the monitor or electronic viewfinder is damaged, stop using the camera immediately. The damaged parts may harm your hands, face, etc.

Notes on continuous shooting

During continuous shooting, the monitor or viewfinder may flash between the shooting screen and a black screen. If you keep watching the screen in this situation, you may experience uncomfortable symptoms such as feeling of unwellness. If you experience uncomfortable symptoms, stop using the camera, and consult your doctor as necessary.

Notes on recording for long periods of time or recording 4K movies

- Depending on the camera and battery temperature, you may be unable to record movies or the power may turn off automatically to protect the camera. A message will be displayed on the screen before the power turns off or you can no longer record movies. In this case, leave the power off and wait until the camera and battery temperature goes down. If you turn on the power without letting the camera and battery cool enough, the power may turn off again or you may be unable to record movies.
- When the temperature of the camera rises, the image quality may deteriorate. It is recommended that you wait until the temperature of the camera drops before continuing to shoot.
- Under high ambient temperatures, the temperature of the camera rises quickly.
- Camera body and battery may get warm with use – this is normal.

- If the same part of your skin touches the camera for a long period of time while using the camera, even if the camera does not feel hot to you, it may cause symptoms of a low-temperature burn such as redness or blistering. Pay special attention in the following situations and use a tripod, etc.
 - When using the camera in a high-temperature environment
 - When someone with poor circulation or impaired skin sensation uses the camera
- Especially during 4K movie shooting, the recording time may be shorter under low temperature conditions. Warm up the battery pack or replace it with a new battery.

Notes on recording/playback

- Before you start recording, make a trial recording to make sure that the camera is working correctly.
- The recorded image may be different from the image you monitored before recording.
- Do not use the camera in areas where strong radio waves or radiation are being emitted. Recording and playback may not function correctly.
- Playback of images recorded with your product on other equipment and playback of images recorded or edited with other equipment on your product are not guaranteed.

- Sony can provide no guarantees in the event of failure to record or loss or damage of recorded images or audio data due to a malfunction of the camera or recording media, etc. We recommend backing up important data.
- Once you format the memory card, all the data recorded on the memory card will be deleted and cannot be restored. Before formatting, copy the data to a computer or other device.

Sony accessories

Using this unit with products from other manufacturers may affect its performance, leading to accidents or malfunction.

On the data specifications described in this manual

The data on performance and specifications are defined under the following conditions, except as described in this manual: at an ordinary ambient temperature of 25°C (77°F), and using a battery pack that has been fully charged until the charge lamp has turned off.

Warning on copyright

Television programs, films, videotapes, and other materials may be copyrighted. Unauthorized recording of such materials may be contrary to the provisions of the copyright laws.

Notes on location information

If you upload and share an image tagged with a location, you may accidentally reveal the information to a third party. To prevent third parties from obtaining your location information, set [□ Loc. Info. Link Set.] to [Off] before shooting images.

Notes on discarding or transferring this product to others

When discarding or transferring this product to others, make sure to perform the following operation to protect private information.

- Select [Setting Reset] → [Initialize].

Notes on discarding or transferring a memory card to others

Executing [Format] or [Delete] on the camera or a computer may not completely delete the data on the memory card. When transferring a memory card to others, we recommend that you delete the data completely using data deletion software. When discarding a memory card, we recommend that you physically destroy it.

Notes on wireless LAN

If your camera is lost or stolen, Sony bears no responsibility for the loss or damage caused by illegal access or use of the registered access point on the camera.

Notes on security when using wireless LAN products

- Always make sure that you are using a secure wireless LAN to avoid hacking, access by malicious third parties, or other vulnerabilities.

- It is important that you set the security settings when using a wireless LAN.
- If a security problem arises because no security precautions are in place or due to any inevitable circumstances when using a wireless LAN, Sony bears no responsibility for the loss or damage.

How to turn off wireless network functions (Wi-Fi, etc.) temporarily

When you board an airplane, etc., you can turn off all wireless network functions temporarily using [Airplane Mode].

For Customers in the U.S.A.

For question regarding your product or for the Sony Service Center nearest you, call 1-800-222-SONY (7669).

Declaration of Conformity

Trade Name: SONY

Model No.: WW771132

Responsible Party: Sony Electronics Inc.

Address: 16535 Via Esprillo, San Diego, CA 92127 U.S.A.

Telephone Number: 858-942-2230

This device complies with part 15 of the FCC rules. Operation is subject to the following two conditions: (1) This device may not cause harmful interference, and (2) this device must accept any interference received, including interference that may cause undesired operation.

Checking the camera and the supplied items

The number in parentheses indicates the number of pieces.

- Camera (1)
- Power cord (mains lead) (1)
(supplied in some countries/
regions)



- Rechargeable battery pack
NP-BX1 (1)



- Micro USB cable (1)

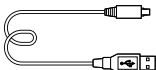

- AC Adaptor (1)

The shape of the AC Adaptor may differ depending on the country/region.

- Wrist strap (1)



- Strap adaptor (2)



- Instruction Manual (this
manual) (1)
- Reference Guide (1)
- Wi-Fi Connection/One-touch
(NFC) Guide (1)

Identifying parts

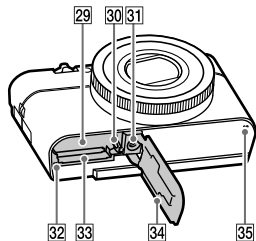
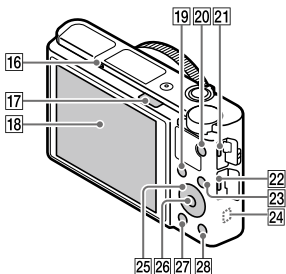
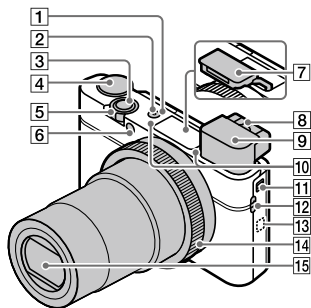

1 ON/OFF (Power) button

2 Power/Charge lamp

3 Shutter button

4 Mode dial

AUTO (Auto Mode)/

P (Program Auto)/

A (Aperture Priority)/

S (Shutter Priority)/

M (Manual Exposure)/

MR (Memory recall)/

Movie (Movie)/

HFR (High Frame Rate)/

Sweep Panorama (Sweep Panorama)/

SCN (Scene Selection)

5 For shooting: **W/T** (Zoom) lever

For viewing: **Index** lever/
Playback zoom lever

6 Self-timer lamp/AF illuminator

7 Flash

- Do not cover the flash with your finger.

- When using the flash, slide the **Flash pop-up** switch. If not using the flash, press it down manually.

8 Diopter-adjustment lever

- Adjust the diopter-adjustment lever according to your eyesight until the display appears clearly in the viewfinder.

9 Viewfinder (11)

- When you look into the viewfinder, the viewfinder mode is activated, and when you take your face away from the viewfinder, the viewing mode returns to the monitor mode.

10 Microphone

11 Viewfinder pop-up switch

12 Hook for strap

- Attach the wrist strap and place your hand through the loop to prevent damage caused by dropping the product.

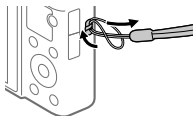

- To use a shoulder strap (sold separately), attach the strap adaptors (supplied) to the strap hooks on either side of the camera.

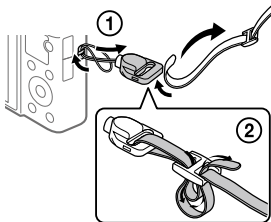

13 N (N mark)

This mark indicates the touch point for connecting the camera and an NFC-enabled Smartphone.

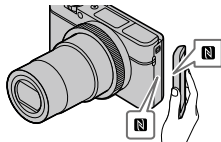

- NFC (Near Field Communication) is an international standard of the short-range wireless communication technology.

14 Control ring

15 Lens

16 Eye sensor

17 ⚡ (Flash pop-up) switch

- 18 Monitor**
(For touch operation: Touch panel/Touch pad)
You can adjust the monitor to an easily viewable angle and shoot from any position.

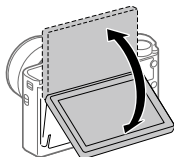

You may not be able to adjust the monitor angle depending on the type of a tripod you use. In such a case, release the tripod screw once to adjust the monitor angle.

- 19 For shooting: Fn (Function) button**
For viewing:
↵ (Send to Smartphone) button
- 20 MOVIE (Movie) button**
- 21 Multi/Micro USB Terminal**
- This terminal supports Micro USB-compatible devices.
 - For details on compatible accessories for the Multi/Micro USB Terminal, visit the Sony website, or consult your Sony dealer or local authorized Sony service facility.
- 22 HDMI micro jack**
- 23 MENU button**

- 24 Wi-Fi/Bluetooth antenna (built-in)**
- 25 Control wheel**
- 26 Center button**
- 27 ▶ (Playback) button**
- 28 C/⏏ (Custom/Delete) button**
- 29 Battery insertion slot**
- 30 Battery lock lever**
- 31 Tripod socket hole**
Use a tripod with a screw less than 5.5 mm (7/32 inches) long. Otherwise, you cannot firmly secure the camera, and damage to the camera may occur.
- 32 Access lamp**
- 33 Memory card slot**
- 34 Battery/Memory card cover**
- 35 Speaker**

■ When using the viewfinder

① Slide down the viewfinder pop-up switch.

- If you slide the viewfinder pop-up switch when the power is off, the camera turns on.
- To choose whether or not to turn the camera off when the viewfinder is stowed, select MENU →  (Setup) → [Function for VF close].

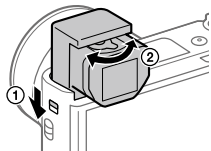

② Adjust the diopter-adjustment lever to your eyesight until the display appears clearly in the viewfinder.

To store the viewfinder

Push down the top of the viewfinder.

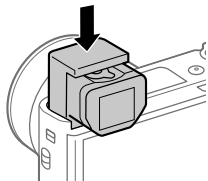





Note

- Be careful not to push down on the viewfinder when it is being raised.
- Be sure to push the viewfinder down slowly so that the eyepiece part does not get stuck.

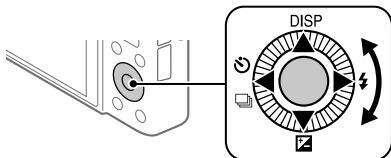

Basic operations

Using the control wheel



- You can select setting items by turning or pressing the top/bottom/left/right side of the control wheel. Your selection is determined when you press the center of the control wheel.
- The DISP (Display Setting),  (Exposure Comp.),  (Drive Mode), and  (Flash Mode) functions are assigned to the top/bottom/left/right side of the control wheel. In addition, you can assign selected functions to the left/right side and the center of the control wheel.
- During playback, you can display the next/previous image by pressing the right/left side of the control wheel or by turning the control wheel.

Using the control ring

By turning the control ring, you can change the desired settings instantly for various shooting modes. You can also allocate frequently used functions to the control ring by selecting MENU →  (Camera Settings2) → [ Custom Key] or [ Custom Key] → [Control Ring].

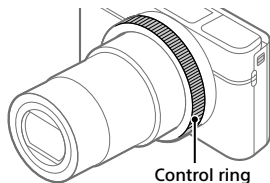

Icons and function names are displayed on the screen as follows.

Ex.

 **ZOOM**: Adjust zoom by turning the control ring.

Using the Fn (Function) button

You can register frequently used functions to the Fn (Function) button and recall them while shooting. Up to 12 frequently used functions can be registered to the Fn (Function) button.

- 1 Press the DISP button on the control wheel repeatedly to display a screen mode other than [For viewfinder], and then press the Fn (Function) button.**

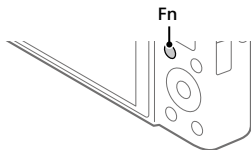

- 2 Select the desired function by pressing the top/bottom/left/right side of the control wheel.**

- 3 Select the desired setting by turning the control wheel, and press the center of the control wheel.**

- Some functions can be fine-tuned using the control ring.

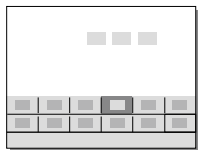

To adjust settings from the dedicated setting screens

Select the desired function in step 2, then press the center of the control wheel. The dedicated setting screen for the function will appear. Follow the operating guide to adjust settings.

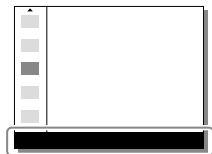

Operation guide

Startup guide

Step 1: Inserting the battery pack/memory card (sold separately) into the camera

For details on memory cards that can be used with this camera, refer to page 29.

1 Open the battery/memory card cover, and insert the battery pack into the camera.

- Make sure that the battery pack is facing in the correct direction and insert it while pressing the battery lock lever.

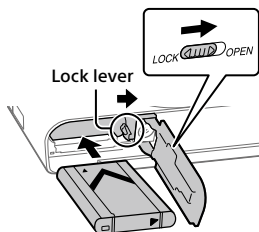

2 Insert the memory card (sold separately) into the camera.

- With the notched corner facing in the direction illustrated, insert the memory card until it clicks into place.

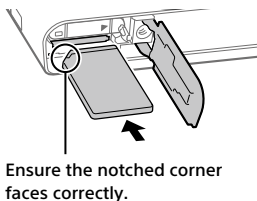

3 Close the cover.

■ To format the memory card

When you use a memory card with this camera for the first time, it is recommended that you format the card using the camera in order to stabilize the performance of the memory card.

- Formatting erases all data on the memory card, including protected images and registered settings (M1 to M4). Once erased, this data cannot be restored. Save valuable data to a computer, etc. before formatting.
- To perform formatting, select MENU →  (Setup) → [Format].

■ To remove the battery pack

Make sure that the access lamp (page 10) is not lit, and turn off the camera. Then, slide the lock lever and remove the battery pack. Be careful not to drop the battery pack.

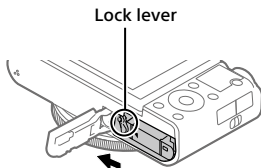

■ To remove the memory card

Make sure that the access lamp (page 10) is not lit, and then push in the memory card once to remove it.

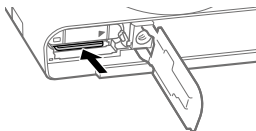

Step 2: Charging the battery pack while it is inserted in the camera

1 Turn the power off.

2 Connect the camera with the battery pack inserted to the AC Adaptor (supplied) using the micro USB cable (supplied), and connect the AC Adaptor to the wall outlet (wall socket).

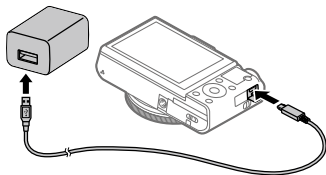

Charge lamp on the camera (orange)

Lit: Charging

Off: Charging finished

Flashing: Charging error or charging paused temporarily because the camera is not within the proper temperature range

- Charging time (full charge): approximately 150 min (when charging a fully depleted battery pack at a temperature of 25°C (77°F))
 - When you use a completely new battery pack or a battery pack that has not been used for a long time, the charge lamp may flash quickly when the battery is charged. If this happens, remove the battery pack or disconnect the USB cable from the camera and then re-insert it to recharge.
 - Be sure to use only genuine Sony brand battery packs, micro USB cables (supplied) and AC Adaptors (supplied).
-

Step 3: Setting the language and the clock

- 1 Press the ON/OFF (Power) button to turn on the camera.

ON/OFF (Power) button

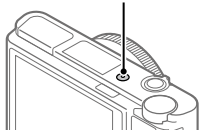

- 2 Select the desired language and then press the center of the control wheel.

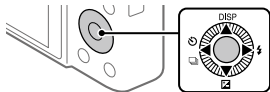

- 3 Make sure that [Enter] is selected on the screen and then press the center.

- 4 Select the desired geographic location and then press the center.

- 5 Select [Date/Time] using the top/bottom of the control wheel or by turning the control wheel, and then press the center.

- 6 Select the desired setting by pressing the top/bottom/left/right side of the control wheel, and then press the center.

- 7 Repeat steps 5 and 6 to set other items, then select [Enter] and press the center.

Hint

- To reset the date and time setting, use MENU (page 26).

Step 4: Shooting images in auto mode

- 1 Turn the mode dial to set to **AUTO**.

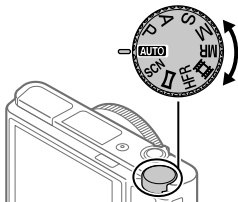

-
- 2 Look into the viewfinder or the monitor and hold the camera.

-
- 3 Use the W/T (zoom) lever to adjust the magnification of the image.

-
- 4 Press the shutter button halfway down to focus.

- When the image is in focus, an indicator (such as ●) will light up.

-
- 5 Press the shutter button all the way down.

■ To shoot movies

Press the MOVIE button to start/stop recording.

■ To play back images

Press the  (Playback) button to play back images. You can select the desired image using the control wheel.

■ To delete displayed image

Press the  (Delete) button while an image is displayed to delete it. Select [Delete] using the control wheel on the confirmation screen, and then press the center of the control wheel to delete the image.

■ To shoot images in various shooting modes

Set the mode dial to the desired mode depending on the subject or the functions you want to use.

Learning more about the camera

Instructions for all the functions of this camera are provided in the “Help Guide” (web manual).

Refer to page 2 for how to access the Help Guide.

Using the Wi-Fi / One-touch (NFC) / Bluetooth functions

You can perform the following operations using the camera's Wi-Fi, NFC One-touch, and Bluetooth functions.

- Saving images to a computer
- Transferring images from the camera to a smartphone
- Using a smartphone as a remote control for the camera
- Viewing still images on a TV
- Recording location information from a smartphone to images

For details, refer to the "Help Guide" (page 2) or to the attached document "Wi-Fi Connection/One-touch (NFC) Guide."

Installing PlayMemories Mobile

PlayMemories Mobile is required to connect the camera and a smartphone. If PlayMemories Mobile is already installed on your smartphone, be sure to update it to the latest version.

For details on PlayMemories Mobile, refer to the support page (<http://www.sony.net/pmm/>).



PlayMemories
Mobile



Note

- To use the camera's NFC One-touch function, an NFC-enabled Android smartphone or tablet is required.
- The Wi-Fi functions introduced in this manual are not guaranteed to operate on all smartphones or tablets.
- The Wi-Fi functions of this camera are not available when connected to a public wireless LAN.
- Depending on future version upgrades, the operational procedures or screen displays are subject to change without notice.

Recording location information to captured images

By using PlayMemories Mobile, you can obtain location information from a connected smartphone (via Bluetooth communication) and record it to captured images.

For details on the operating procedure, refer to the "Help Guide" (page 2) or the following support page.



<http://www.sony.net/pmm/btg/>

Introduction to computer software

We offer the following computer software to enhance your enjoyment of photos/movies. Access one of the following URLs using your Internet browser and then download the software by following the onscreen instructions.

If one of these software is already installed on your computer, update it to the latest version before use.

Windows:

<http://www.sony.co.jp/imsoft/Win/>

Mac:

<http://www.sony.co.jp/imsoft/Mac/>

You can check the recommended operating environment for the software from the following URL:

<http://www.sony.net/pcenv/>

PlayMemories Home

PlayMemories Home allows you to import still images and movies to your computer and view or use them.

You need to install PlayMemories Home to import XAVC S movies or AVCHD movies to your computer.

You can access the download website directly from the following URL:

<http://www.sony.net/pm/>

- When you connect the camera to your computer, new functions may be added to PlayMemories Home. Connecting the camera to your computer is therefore recommended even if PlayMemories Home has already been installed on the computer.

Imaging Edge

Imaging Edge is a software suite that includes functions such as remote shooting from a computer, and adjusting or developing RAW images recorded with the camera.

Viewer: You can display and search images.

Edit: You can edit images with various corrections such as tone curve and sharpness, and develop images recorded in RAW format.

Remote: You can adjust the camera settings or shoot images from a computer connected to the camera with a USB cable.

- To control the camera using a computer, select MENU →  (Setup) → [USB Connection] → [PC Remote] before connecting the camera to the computer with a USB cable.







List of MENU items

For details on each MENU items, refer to the Help Guide.







1 (Camera Settings1)

Red tab



Quality/Image Size



-  File Format
-  JPEG Quality
-  JPEG Image Size
-  Aspect Ratio
- Panorama: Size
- Panorama: Direction
-  Long Exposure NR
-  High ISO NR
-  Color Space

Shoot Mode/Drive

- Auto Mode
- Scene Selection
- Drive Mode
- Bracket Settings
-   1/ 2 Recall
-   1/ 2 Memory

AF

- Focus Mode
- Focus Area
-  Swt. V/H AF Area
-  AF Illuminator
- Center Lock-on AF
- Set. Face Prty in AF
-  Pre-AF

-  AF Area Regist.
-  Del. Reg. AF Area
- AF Area Auto Clear
- Disp. cont. AF area
- Phase Detect. Area

Exposure

- Exposure Comp.
- ISO
- ISO AUTO Min. SS
- Metering Mode
- Face Prty in Mlti Mtr
- Spot Metering Point
-  AEL w/ shutter
- Exposure Std. Adjust



Flash

- Flash Mode
- Flash Comp.
- Red Eye Reduction

Color/WB/Img. Processing

- White Balance
- Priority Set in AWB
- DRO/Auto HDR
- Creative Style
- Picture Effect
- Picture Profile
-  Soft Skin Effect

Focus Assist











- Focus Magnifier
- Focus Magnif. Time
-  Initial Focus Mag.
-  MF Assist
- Peaking Setting



Shooting Assist

- Face Registration
- Regist. Faces Priority
- Smile Shutter
-  Auto Obj. Framing
- Self-portrait/ -timer



2 (Camera Settings2) Purple tab

Movie

-  Exposure Mode
-  Exposure Mode
-  File Format
-  Record Setting
-  HFR Settings
- Quality (Dual Rec)
- Img. Size (Dual Rec)
- Auto Dual Rec
-  Proxy Recording
-  AF drive speed
-  AF Track Sens
-  Auto Slow Shut.
- Audio Recording
- Micref Level
- Wind Noise Reduct.
-  SteadyShot

-  Marker Display
-  Marker Settings
- Movie w/ shutter

Shutter/SteadyShot

-  Shutter Type
- Release w/o Card
-  SteadyShot





Zoom

- Zoom Setting
- Zoom Speed
- Zoom Func. on Ring

Display/Auto Review

- DISP Button
- FINDER/MONITOR
- Zebra Setting
- Grid Line
- Exposure Set. Guide
- Live View Display
- Auto Review

Custom Operation

-  Custom Key
-  Custom Key
-  Custom Key
- Function Menu Set.
- Av/Tv Rotate
-  Touch Shoot. Set.
- MOVIE Button
- Wheel Lock
- Audio signals
-  Write Date

🌐 (Network)

Green tab

Snd to Smrtphn Func
Send to Computer (Wi-Fi)
View on TV
Ctrl w/ Smartphone
Airplane Mode
Wi-Fi Settings
Bluetooth Settings
📶 Loc. Info. Link Set.
Edit Device Name
Reset Network Set.

▶ (Playback)

Blue tab

Protect
Rotate
Delete
Rating
Rating Set(Cust Key)
Specify Printing
Beauty Effect
Photo Capture
🔍 Enlarge Image
🔍 Enlarge Init. Mag.
🔍 Enlarge Initial Pos.
Motion Interval ADJ
Slide Show
View Mode
Image Index
Disp Cont Shoot Grp
Display Rotation

🗑️ (Setup)

Yellow tab

Monitor Brightness
Viewfinder Bright.
Finder Color Temp.
Gamma Disp. Assist
Volume Settings
Tile Menu
Mode Dial Guide
Delete confirm.
Display Quality
Auto Monitor OFF
Pwr Save Start Time
Function for VF close
NTSC/PAL Selector*
Touch Operation
Touch Panel/Pad
Touch Pad Settings
Demo Mode
TC/UB Settings
HDMI Settings
📺 4K Output Sel.
USB Connection
USB LUN Setting
USB Power Supply
PC Remote Settings
🗣️ Language
Date/Time Setup
Area Setting
Copyright Info
Format
File Number
Set File Name
Select REC Folder
New Folder

Folder Name

Recover Image DB

Display Media Info.

Version

Setting Reset

* If you change this item, you will need to format the memory card for compatibility with the PAL or NTSC system. Also, note that it may not be possible to play back movies recorded for the NTSC system on PAL system TVs.

★ (My Menu)

Gray tab

Add Item

Sort Item

Delete Item

Delete Page

Delete All

Specifications

Battery life and number of recordable images

		Battery life	Number of images
Shooting (still images)	Screen mode	—	Approx. 240 Approx. 310 (Auto Monitor OFF (2 Sec))
	Viewfinder mode	—	Approx. 220
Actual shooting (movies)	Screen mode	Approx. 40 min.	—
	Viewfinder mode	Approx. 40 min.	—
Continuous shooting (movies)	Screen mode	Approx. 75 min.	—
	Viewfinder mode	Approx. 70 min.	—

- The above estimates for battery life and number of recordable images apply when the battery pack has been fully charged. The battery life and number of images may decrease depending on the conditions of use.
- The battery life and number of recordable images are estimates based on shooting with the default settings under the following conditions:
 - Using the battery pack at an ambient temperature of 25°C (77°F).
 - Using a Sony SDXC memory card (U3) (sold separately)
- The numbers for “Shooting (still images)” are based on the CIPA standard and shooting under the following conditions:
(CIPA: Camera & Imaging Products Association)
 - One picture is taken every 30 seconds.
 - The power is turned on and off once every ten times.
 - The flash strobes once for every two pictures.
 - The zoom is switched alternately between the W and T ends.
- The number of minutes for movie shooting is based on the CIPA standard and shooting under the following conditions:
 - The image quality is set to XAVC S HD 60p 50M/50p 50M.
 - Actual shooting (movies): Battery life based on repeated shooting, zooming, shooting stand-by, turning on/off, etc.
 - Continuous shooting (movies): Battery life based on non-stop shooting until the limit (29 minutes) has been reached, and then continued by pressing the MOVIE (Movie) button again. Other functions, such as zooming, are not operated.

Memory cards that can be used

When using microSD memory cards or Memory Stick Micro media with this camera, be sure to use the appropriate adaptor.

SD memory cards

Recording format		Supported memory card
Still image		SD/SDHC/SDXC card
AVCHD		SD/SDHC/SDXC card (Class 4 or faster, or U1 or faster)
XAVC S	4K 60 Mbps* HD 50 Mbps or lower* HD 60 Mbps	SDHC/SDXC card (Class 10, or U1 or faster)
	4K 100 Mbps* HD 100 Mbps	SDHC/SDXC card (U3)
	High Frame Rate*	SDHC/SDXC card (Class 10, or U1 or faster)

* Including when recording proxy movies at the same time

Memory Stick media

Recording format		Supported memory card
Still image		Memory Stick PRO Duo/ Memory Stick PRO-HG Duo
AVCHD		Memory Stick PRO Duo (Mark 2)/ Memory Stick PRO-HG Duo
XAVC S	4K 60 Mbps* HD 50 Mbps or lower* HD 60 Mbps	Memory Stick PRO-HG Duo
	4K 100 Mbps* HD 100 Mbps	—
	High Frame Rate*	Memory Stick PRO-HG Duo

* Including when recording proxy movies at the same time

Note

- When an SDHC memory card is used to record an XAVC S movie over extended periods of time, the recorded movies will be divided into files 4 GB in size. The divided files can be handled as a single file by importing them to a computer using PlayMemories Home.
- Fully charge the battery pack before attempting to recover the database files on the memory card.

Number of recordable images

When you insert a memory card into the camera and turn the camera on, the number of images that can be recorded (should you continue to shoot using the current settings) is displayed on the screen.

Note

- When “0” (the number of recordable images) flashes in orange, the memory card is full. Replace the memory card with another one, or delete images from the current memory card.
- When “NO CARD” flashes in orange, it means no memory card has been inserted. Insert a memory card.



The number of images that can be recorded on a memory card

The table below shows the approximate number of images that can be recorded on a memory card formatted with this camera. The values are defined using Sony standard memory cards for testing. The values may vary depending on the shooting conditions and the type of memory card used.

[ JPEG Image Size]: [L: 20M]

[ Aspect Ratio]: [3:2]*1

(Units: Images)

 JPEG Quality/  File Format	8 GB	32 GB	64 GB	256 GB
Standard	1150	4800	9600	37500
Fine	690	2800	5500	22000
Extra fine	510	2050	4150	16000
RAW & JPEG*2	235	950	1900	7500
RAW	355	1400	2850	11000

*1 When [ Aspect Ratio] is set to other than [3:2], you can record more images than the numbers shown in the table above (except when [RAW] is selected).

*2 [ JPEG Quality] when [RAW & JPEG] is selected: [Fine]

Note

- Even if the number of recordable images is higher than 9999 images, “9999” will appear.
- The numbers shown are when using a Sony memory card.

Recordable movie times

The table below shows the approximate total recording times using a memory card formatted with this camera. The values may vary depending on the shooting conditions and the type of memory card used. The recording times for when [File Format] is set to [XAVC S 4K] and [XAVC S HD] are recording times when shooting with [Proxy Recording] set to [Off].

(h (hour), m (minute))



File Format	Record Setting	8 GB	32 GB	64 GB	256 GB
XAVC S 4K	30p 100M/25p 100M	9 m	35 m	1 h 15 m	5 h 15 m
	30p 60M/25p 60M	10 m	1 h	2 h 5 m	8 h 35 m
	24p 100M*/ -	9 m	35 m	1 h 15 m	5 h 15 m
	24p 60M*/ -	10 m	1 h	2 h 5 m	8 h 35 m
XAVC S HD	120p 100M/100p 100M	9 m	35 m	1 h 15 m	5 h 15 m
	120p 60M/100p 60M	10 m	1 h	2 h 5 m	8 h 35 m
	60p 50M/50p 50M	15 m	1 h 15 m	2 h 35 m	10 h 25 m
	60p 25M/50p 25M	30 m	2 h 25 m	5 h	20 h 10 m
	30p 50M/25p 50M	15 m	1 h 15 m	2 h 35 m	10 h 25 m
	30p 16M/25p 16M	50 m	3 h 50 m	7 h 45 m	31 h 30 m
	24p 50M*/ -	15 m	1 h 15 m	2 h 35 m	10 h 25 m
AVCHD	60i 24M (FX)/ 50i 24M (FX)	40 m	2 h 55 m	6 h	24 h 15 m
	60i 17M (FH)/ 50i 17M (FH)	55 m	4 h 5 m	8 h 15 m	33 h 15 m

- * Only when [NTSC/PAL Selector] is set to NTSC
- Continuous movie shooting is possible for a maximum of approximately 29 minutes at a time with the camera's default settings and an ambient temperature of approximately 25°C (77°F). However, the recording time is approximately 5 minutes when shooting movies in XAVC S 4K or XAVC S HD 120p/100p format. (product specification limit)

Note

- The recordable time of movies varies because the camera is equipped with VBR (Variable Bit-Rate), which automatically adjusts image quality depending on the shooting scene. When you record a fast-moving subject, the image is clearer but the recordable time is shorter because more memory is required for recording. The recordable time also varies depending on the shooting conditions, the subject or the image quality/size settings.
- The times shown are recordable times using a Sony memory card.

Notes on continuous movie recording

- High-quality movie recording and high-speed continuous shooting require large amounts of power. Therefore, if you continue to shoot, the temperature inside the camera will rise, especially that of the image sensor. In such cases, the camera will turn off automatically because the surface of the camera is heated to a high temperature or the high temperature affects the quality of the images or the internal mechanism of the camera.
- The duration of time available for movie recording varies with the temperature, file format/record setting for movies, Wi-Fi network environment, or condition of the camera before you start recording. If you frequently recompose or shoot images after the power is turned on, the temperature inside the camera will rise and the recording time available will be shorter.
- If the  icon appears, the temperature of the camera has risen.
- If the camera stops movie recording due to a high temperature, leave it for some time with the power turned off. Start recording after the temperature inside the camera drops fully.
- If you observe the following points, you will be able to record movies for longer periods of time.
 - Keep the camera out of direct sunlight.
 - Turn the camera off when it is not being used.
- When  File Format] is set to [AVCHD], the file size of movies is limited to approx. 2 GB. If the movie file size reaches approx. 2 GB during recording, a new movie file will be created automatically.

Specifications

Camera

[System]

Camera Type: Digital Still Camera

[Image sensor]

Image format: 13.2 mm × 8.8 mm
(1.0 type), CMOS image sensor

Effective pixel number of camera:
Approx. 20 100 000 pixels

Total pixel number of camera:
Approx. 21 000 000 pixels

[Lens]

ZEISS Vario-Sonnar T*

f = 9.0 mm – 72 mm (24 mm –
200 mm (35 mm film equivalent))
F2.8 (W) – F4.5 (T)

While shooting movies (HD 16:9):
24 mm – 210 mm*

While shooting movies (4K 16:9):
26 mm – 230 mm

* When [SteadyShot] is set to
[Standard]

[SteadyShot]

Optical

[Auto focus system]

Detection system: Phase detection
system/Contrast detection
system

[Flash]

Flash range (ISO sensitivity
(Recommended Exposure Index)
set to Auto): Approx. 0.4 m to
5.9 m (1.31 ft. to 19.35 ft.) (W)/
Approx. 1.0 m to 3.1 m (3.28 ft. to
10.17 ft.) (T)

[Electronic viewfinder]

Type: 1.0 cm (0.39 type) Electronic
Viewfinder

Total number of dots: 2 359 296 dots

Magnification: Approx. 0.59× with
50 mm lens at infinity, -1 m^{-1}

Eye Point: Approx. 20 mm from the
eyepiece and approx. 19.2 mm
from the eyepiece frame at -1 m^{-1}

Diopter Adjustment:
 -4.0 m^{-1} to $+3.0\text{ m}^{-1}$

[Monitor]

7.5 cm (3.0 type) TFT drive, touch
panel

Total number of dots: 921 600 dots

[Recording format]

File format: JPEG (DCF Ver. 2.0,
Exif Ver. 2.31, MPF Baseline)
compliant, RAW (Sony ARW 2.3
format)

Movie (XAVC S format):
MPEG-4 AVC/H.264 XAVC S
ver.1.0 format compliant
Video: MPEG-4 AVC/H.264
Audio: LPCM 2ch (48 kHz 16 bit)

Movie (AVCHD format):
AVCHD format Ver. 2.0
compatible
Video: MPEG-4 AVC/H.264
Audio: Dolby Digital 2ch,
equipped with
Dolby Digital Stereo Creator

- Manufactured under license from
Dolby Laboratories.

[Recording media]

Memory Stick PRO Duo media,
Memory Stick Micro media, SD
cards, microSD memory cards

[Input/output terminals]

Multi/Micro USB Terminal*:

Hi-Speed USB (USB 2.0)

- * Supports Micro USB compatible devices.

HDMI: HDMI type D micro jack

[General]

Model No. WW771132

Rated input: 3.6 V , 2.5 W

Operating temperature:

0 to 40°C (32 to 104°F)

Storage temperature:

-20 to 55°C (-4 to 131°F)

Dimensions (W/H/D) (Approx.):

101.6 mm × 58.1 mm × 42.8 mm

(4 inches × 2 3/8 inches ×

1 11/16 inches)

Mass (CIPA compliant) (Approx.):

301 g (10.7 oz) (including battery pack, SD card)

[Wireless LAN]

Supported format: IEEE 802.11 b/g/n

Frequency band: 2.4 GHz

Security: WEP/WPA-PSK/WPA2-PSK

Connection method:

Wi-Fi Protected Setup™ (WPS)/
Manual

Access method: Infrastructure mode

[NFC]

Tag type: NFC Forum Type 3 Tag
compliant

[Bluetooth communications]

Bluetooth standard Ver. 4.1

Frequency band: 2.4 GHz

AC Adaptor

AC-UUD12/AC-UUE12

Rated input:

100 - 240 V , 50/60 Hz, 0.2 A

Rated output: 5 V , 1.5 A

Rechargeable battery pack NP-BX1



Rated voltage: 3.6 V 

Design and specifications are subject to change without notice.

On image data compatibility

- This camera conforms with DCF (Design rule for Camera File system) universal standard established by JEITA (Japan Electronics and Information Technology Industries Association).
- Playback of images recorded with your camera on other equipment and playback of images recorded or edited with other equipment on your camera are not guaranteed.

Trademarks

- Memory Stick and  are trademarks or registered trademarks of Sony Corporation.
- XAVC S and  are registered trademarks of Sony Corporation.
- “AVCHD” and the “AVCHD” logotype are trademarks of Panasonic Corporation and Sony Corporation.
- Mac is a trademark of Apple Inc., registered in the United States and other countries.
- IOS is a registered trademark or trademark of Cisco Systems, Inc.
- iPhone and iPad are trademarks of Apple Inc., registered in the U.S. and other countries.
- Blu-ray Disc™ and Blu-ray™ are trademarks of the Blu-ray Disc Association.
- DLNA and DLNA CERTIFIED are trademarks of Digital Living Network Alliance.
- Dolby, Dolby Audio and double-D symbol are trademarks of Dolby Laboratories.
- The terms HDMI and HDMI High-Definition Multimedia Interface, and the HDMI Logo are trademarks or registered trademarks of HDMI Licensing Administrator, Inc. in the United States and other countries.
- Microsoft and Windows are registered trademarks or trademarks of Microsoft Corporation in the United States and/or other countries.
- SDXC logo is a trademark of SD-3C, LLC.
- Android and Google Play are trademarks or registered trademarks of Google Inc.
- Wi-Fi, the Wi-Fi logo and Wi-Fi Protected Setup are registered trademarks or trademarks of the Wi-Fi Alliance.
- The N Mark is a trademark or registered trademark of NFC Forum, Inc. in the United States and in other countries.
- The Bluetooth® word mark and logos are registered trademarks owned by the Bluetooth SIG, Inc. and any use of such marks by Sony Corporation is under license.
- QR Code is a trademark of Denso Wave Inc.
- In addition, system and product names used in this manual are, in general, trademarks or registered trademarks of their respective developers or manufacturers. However, the ™ or ® marks may not be used in all cases in this manual.

LITHIUM ION  TYPE

 MEMORY STICK

 CLASS

 HIGH-DEFINITION MULTIMEDIA INTERFACE









■ On GNU GPL/LGPL applied software

The software that is eligible for the following GNU General Public License (hereinafter referred to as "GPL") or GNU Lesser General Public License (hereinafter referred to as "LGPL") are included in the product.

This informs you that you have a right to have access to, modify, and redistribute source code for these software programs under the conditions of the supplied GPL/LGPL. Source code is provided on the web. Use the following URL to download it. <http://oss.sony.net/Products/Linux/> We would prefer you do not contact us about the contents of source code.

Licenses (in English) are recorded in the internal memory of your product. Establish a Mass Storage connection between the product and a computer to read licenses in the "PMHOME" - "LICENSE" folder.

Additional information on this product and answers to frequently asked questions can be found at our Customer Support Website.

<http://www.sony.net/>



<http://www.sony.net/SonyInfo/Support/>

